



TABELA

2023



A EMPRESA

ATUSA, situada no Norte de Espanha, região de grande importância sidero metalúrgica, conseguiu um crescimento que permitiu a liderança como fabricante de Acessórios de Ferro Maleável.

A nossa já longa tradição, que remonta, em algumas das nossas fábricas, praticamente a um século de existência serviu para fortalecer as bases de uma empresa moderna, ágil, atual e com futuro.

No seu objectivo de satisfazer as exigências dos diferentes mercados, ATUSA mantém um constante desenvolvimento, incorporando novos produtos destinados a diferentes setores, como o sanitário, aquecimento, condução de fluídos, construções, eléctrico.

A combinação do processo produtivo e a comercialização de produtos faz da ATUSA uma referência nos mercados internacionais.

A sede da ATUSA localiza-se em Salvatierra, província de Alava, onde também se localiza uma das três fábricas, sendo a outra em Mondragon (Guipúzcoa) e a terceira na cidade de Montana na Bulgária.



Fábrica

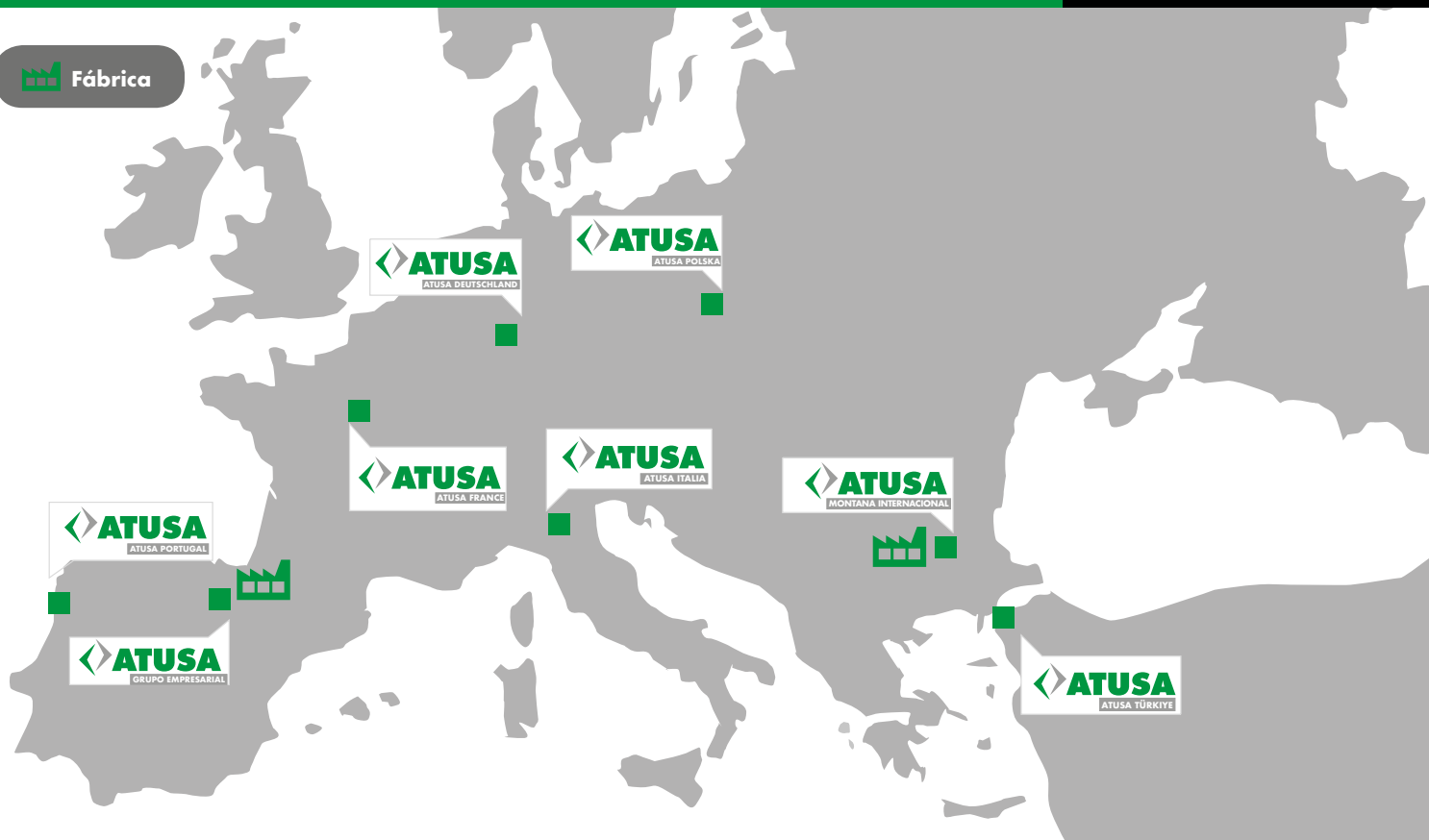

ATUSA possui cinco armazéns logísticos, um na sua sede em Salvatierra, outro na fábrica da Bulgária e os restantes nas filiais:

Ratingen (Alemania) ATUSA DEUTSCHLAND
Milão (Itália) ATUSA ITALIA
Maia (Portugal) ATUSA PORTUGAL.

Temos também Escritórios Comerciais em:
Radom (Polonia) ATUSA POLSKA
Paris (Francia) ATUSA FRANCE
Istambul (Turquia) ATUSA TÜRKIYE

Esta vasta rede de distribuição permite chegar aos nossos clientes num curto prazo de tempo com um ótimo nível de serviço.



ÍNDICE DOS PRODUTOS

6

ACESSÓRIOS EM
FERRO MALEÁVEL



22

JUNTAS
RÁPIDAS



28

SISTEMA
RANHURADO



120

ACESSÓRIOS DE
LATÃO



141

ACESSÓRIOS
POLIETILENO



154

VÁLVULAS DE
FUNDIÇÃO



234

AQUECIMENTO



245

GAMA
CIMBERIO



46

ACESSÓRIOS DE
AÇO



70

ACESSÓRIOS DE
AÇO INOXIDÁVEL



104

PRESS
FITTING



176

VÁLVULAS COM
ATUADOR



196

VÁLVULAS DE
LATÃO



226

SISTEMAS DE
FIXAÇÃO



ACESSÓRIOS EM FERRO MALEÁVEL

ATUSA fabrica acessórios em ferro maleável de coração branco, marca EO. Um cuidado processo produtivo permite obter os melhores produtos em fundição maleável para os mercados mais exigentes.

O seu grande número de referências aliado a um processo de fabrico rigoroso tem como resultado um produto de grande qualidade.

Apesar de estarem presentes no mercado materiais alternativos, o acessório de ferro maleável continua a ser uma referência inquestionável quando se procura um produto nobre e de categoria contrastada.

Os campos de aplicação são diversos, destacando-se: Indústria, sistema contra incêndios, canalização e todo o transporte de fluidos em geral, com uma pressão de trabalho standard a 25 bar e temperaturas entre -20° C e 300° C.

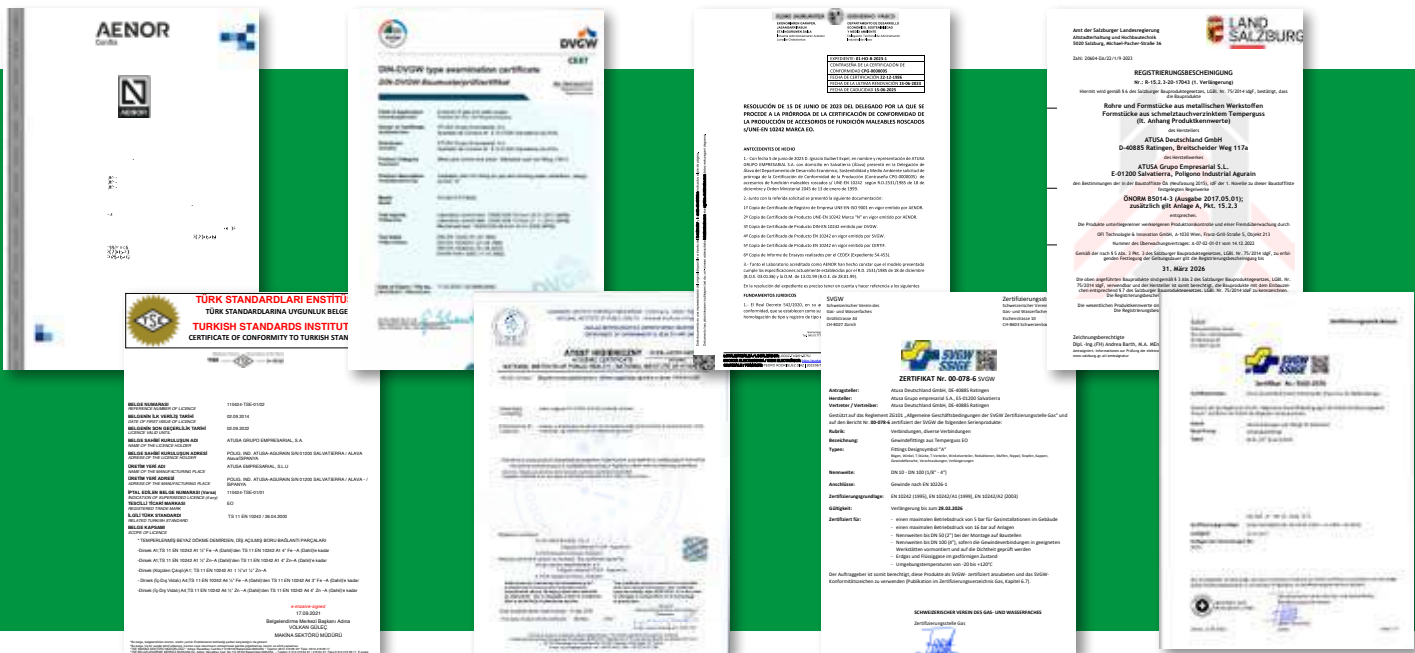



ACESSÓRIOS
EM
FERRO
MALEÁVEL

INDICAÇÕES GERAIS

1. NORMATIVA E IDENTIFICAÇÃO

- Norma de fabrico e utilização EN 10242: 1994.
- Identificação: De acordo com o material selecionado para o fabrico e o tipo de rosca, os acessórios EO são identificados como classe "A", que significa:
 - Geralmente, são fabricados em fundição maleável de coração branco de alta qualidade EN - GJMW 400-05.
 - São roscados conforme a ISO 7/1 com roscas internas cilíndricas (Rp) e roscas externas cónicas (R).

2. GARANTIA DE QUALIDADE

A norma EN 10242:1994 exige que o fabricante estabeleça e mantenha um Sistema da Qualidade documentado e conforme a norma ISO 9001, certificado por um terceiro Organismo de Certificação que atue de acordo com os critérios rigorosos da norma EN ISO/IEC 17021, como meio para assegurar que os acessórios estão conforme os requisitos especificados na norma de produto EN 10242:1994.

Cumprindo com estas exigências a ATUSA tem estabelecido um Sistema de Garantia da Qualidade conforme a ISO 9001 segundo certificado de registo da Empresa AENOR/ER 076/2/95 e confirmação da prestigiosa **IQNet** (Rede Internacional para a Avaliação e Certificação dos Sistemas da Qualidade) que opera de acordo com os critérios da EN ISO/IEC.

3. GALVANIZADO

Os acessórios EO, de acordo com as especificações do pedido, são fornecidos em negro ou galvanizado a quente.

Tal como indica a Norma EN 10242:1994, a massa do revestimento de Zinco deve ser superior a 500gr/m², o que supõe uma espessura média mínima de 70um. Ambos os acabamentos são protegidos por um verniz antioxidante.

As superfícies dos acessórios EO estão isentas de hidrocarbonetos aromáticos policíclicos.

4. ENSAIOS DE ESTANQUIDADE

Em conformidade com a norma EN 10242:1994, ensaia-se unitariamente a estanquidade de todos os acessórios EO mediante uma pressão hidrostática não inferior a 20 bar, equivalente a uma pressão pneumática não inferior a 5 bar.

5. CONDIÇÕES DE FORNECIMENTO

Os aspetos técnicos, de desenho e outras características dos acessórios podem ser modificadas para melhorias técnicas ou alteração de normas.

DIÂMETRO NOMINAL E MEDIDA DE ROSCA

DN	6	8	10	15	20	25	32	40	50	65	80	100	125	150
"	1/8	1/4	3/8	1/2	3/4	1	1 1/4	1 1/2	2	2 1/2	3	4	5	6

RELAÇÃO PRESSÃO / TEMPERATURA

Temperatura de serviço (°C)	Pressão máxima de trabalho (*) (bar)
-20 a 120	25
entre 120 e 300	valores extrapolados
300	20

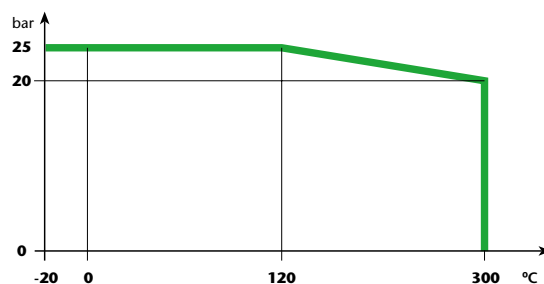

(*) Para utilizações superiores por favor consultar.

 1	 1A	 2	 2A	 3	 40	 41
 60	 85	 90	 90R	 92	 92R	 94
 95	 96	 97	 98	 120	 121	 130
 130R	 131	 132	 133	 134	 135	 165
 180	 220	 221	 223	 240	 241	 245
 246	 270	 271	 280	 281	 290	 291
 294	 300	 310	 312	 320	 321	 330
 331	 334	 340	 341	 344	 370	 371
 372	 374	 471	 526	 529	 531	 596



1 CURVA M/F 90°

ISO/EN **G4**

Ø		NEGRO		GALVANIZADO	
		COD.	€	COD.	€
1/8"	200 10	01001000	3,29	01005000	3,96
1/4"	250 10	01001001	3,11	01005001	3,83
3/8"	170 10	01001002	2,27	01005002	2,76
1/2"	110 10	01001003	2,10	01005003	2,53
3/4"	60 10	01001004	3,19	01005004	3,70
1"	35 1	01001005	4,68	01005005	5,44
1 1/4"	17 1	01001006	8,13	01005006	9,46
1 1/2"	12 1	01001007	11,44	01005007	13,31
2"	6 1	01001008	16,10	01005008	19,63
2 1/2"	3 1	01001009	39,74	01005009	50,03
3"	4 1	0100100A	52,68	0100500A	69,49
4"	2 1	0100100C	112,55	0100500C	141,77



1A CURVA CURTA M/F 90°

ISO/EN **D4**

Ø		NEGRO		GALVANIZADO	
		COD.	€	COD.	€
1/4"	250 10	01A01001	3,35	01A05001	4,07
3/8"	130 10	01A01002	3,06	01A05002	3,71
1/2"	100 10	01A01003	2,74	01A05003	3,46
3/4"	60 10	01A01004	4,04	01A05004	5,16
1"	40 1	01A01005	5,89	01A05005	7,52
1 1/4"	20 1	01A01006	8,68	01A05006	11,13
1 1/2"	15 1	01A01007	12,55	01A05007	16,07
2"	8 1	01A01008	22,03	01A05008	28,27
2 1/2"	3 1	01A01009	44,22	01A05009	54,61
3"	4 1	01A0100A	67,62	01A0500A	84,51
4"	2 1	01A0100C	154,73	01A0500C	195,04



2 CURVA FÊMEA 90°

ISO/EN **G1**

Ø		NEGRO		GALVANIZADO	
		COD.	€	COD.	€
1/4"	200 10	02001001	2,83	02005001	3,46
3/8"	140 10	02001002	2,68	02005002	3,28
1/2"	90 10	02001003	2,46	02005003	2,85
3/4"	50 10	02001004	3,51	02005004	4,17
1"	28 1	02001005	4,81	02005005	5,74
1 1/4"	14 1	02001006	8,41	02005006	10,05
1 1/2"	10 1	02001007	11,43	02005007	13,72
2"	5 1	02001008	15,64	02005008	19,63
2 1/2"	2 1	02001009	44,93	02005009	59,23
3"	4 1	0200100A	60,95	0200500A	80,42
4"	2 1	0200100C	128,78	0200500C	162,18



2A CURVA CURTA FÊMEA 90°

ISO/EN **D1**

Ø		NEGRO		GALVANIZADO	
		COD.	€	COD.	€
3/8"	50 10	02A01002	3,84	02A05002	4,69
1/2"	90 10	02A01003	2,90	02A05003	3,65
3/4"	50 10	02A01004	4,04	02A05004	5,16
1"	35 1	02A01005	5,89	02A05005	7,52
1 1/4"	20 1	02A01006	9,65	02A05006	12,39
1 1/2"	14 1	02A01007	11,83	02A05007	15,20
2"	8 1	02A01008	18,58	02A05008	23,82
2 1/2"	4 1	02A01009	62,79	02A05009	44,87
3"	4 1	02A0100A	69,67	02A0500A	78,03
4"	2 1	02A0100C	154,80	02A0500C	165,14



3 CURVA MACHO 90°

ISO/EN **G8**

Ø		NEGRO		GALVANIZADO	
		COD.	€	COD.	€
1/4"	300 10	03001001	4,86	03005001	5,88
3/8"	200 10	03001002	3,07	03005002	3,71
1/2"	120 10	03001003	3,45	03005003	4,38
3/4"	70 10	03001004	3,81	03005004	4,85
1"	40 1	03001005	6,21	03005005	7,61
1 1/4"	20 1	03001006	10,60	03005006	12,97
1 1/2"	14 1	03001007	15,69	03005007	19,18
2"	7 1	03001008	19,91	03005008	24,43
2 1/2"	3 1	03001009	70,73	03005009	92,60
3"	5 1	0300100A	90,53	0300500A	118,55



40 CURVA M/F 45°

ISO/EN **G4/45°**

Ø		NEGRO		GALVANIZADO	
		COD.	€	COD.	€
1/4"	300 10	04001001	3,59	04005001	4,36
3/8"	200 10	04001002	2,12	04005002	2,60
1/2"	120 10	04001003	2,46	04005003	2,94
3/4"	80 10	04001004	3,34	04005004	4,00
1"	50 1	04001005	4,76	04005005	5,77
1 1/4"	25 1	04001006	7,49	04005006	9,04
1 1/2"	18 1	04001007	8,88	04005007	10,72
2"	10 1	04001008	13,87	04005008	17,53
2 1/2"	6 1	04001009	31,26	04005009	39,36
3"	3 1	0400100A	39,59	0400500A	54,65
4"	4 1	0400100C	104,48	0400500C	131,62



41 CURVA FÊMEA 45°

ISO/EN G1/45°

Ø	Imagem	NEGRO		GALVANIZADO	
		COD.	€	COD.	€
1/4"	220 10	04101001	4,06	04105001	4,98
3/8"	150 10	04101002	3,05	04105002	3,67
1/2"	100 10	04101003	2,60	04105003	3,11
3/4"	60 10	04101004	3,70	04105004	4,28
1"	40 1	04101005	5,44	04105005	6,56
1 1/4"	22 1	04101006	7,66	04105006	9,22
1 1/2"	15 1	04101007	11,29	04105007	14,34
2"	9 1	04101008	15,66	04105008	19,81
2 1/2"	4 1	04101009	32,17	04105009	44,37
3"	2 1	0410100A	45,41	0410500A	61,62
4"	2 1	0410100C	109,92	0410500C	138,43



90 JOELHO SIMPLES 90°

ISO/EN A1

Ø	Imagem	NEGRO		GALVANIZADO	
		COD.	€	COD.	€
1/8"	400 10	09001000	2,19	09005000	2,62
1/4"	350 10	09001001	1,85	09005001	2,28
3/8"	250 10	09001002	1,23	09005002	1,41
1/2"	120 10	09001003	1,08	09005003	1,07
3/4"	90 10	09001004	1,40	09005004	1,41
1"	50 10	09001005	2,09	09005005	2,14
1 1/4"	30 1	09001006	3,50	09005006	3,70
1 1/2"	22 1	09001007	4,46	09005007	4,69
2"	12 1	09001008	5,95	09005008	6,59
2 1/2"	7 1	09001009	16,64	09005009	20,09
3"	4 1	0900100A	25,04	0900500A	33,01
4"	2 1	0900100C	54,10	0900500C	68,18
5"	2 1			0900500D	212,65
6"	1			0900500E	318,25



92 JOELHO SIMPLES M/F 90°

ISO/EN A4

Ø	Imagem	NEGRO		GALVANIZADO	
		COD.	€	COD.	€
1/8"	500 10	09201000	2,55	09205000	3,12
1/4"	350 10	09201001	1,85	09205001	2,28
3/8"	250 10	09201002	1,43	09205002	1,70
1/2"	150 10	09201003	1,14	09205003	1,29
3/4"	90 10	09201004	1,54	09205004	1,60
1"	50 10	09201005	2,61	09205005	2,73
1 1/4"	30 1	09201006	4,42	09205006	4,69
1 1/2"	22 1	09201007	6,05	09205007	6,70
2"	12 1	09201008	8,27	09205008	8,81
2 1/2"	7 1	09201009	18,86	09205009	23,84
3"	4 1	0920100A	30,23	0920500A	39,88
4"	2 1	0920100C	53,04	0920500C	66,82



60 CURVA FÊMEA 180°

Ø	Imagem	NEGRO		GALVANIZADO	
		COD.	€	COD.	€
1/2"	90 1	06001003	15,61	06005003	18,87
3/4"	90 1	06001004	24,06	06005004	28,90
1"	20 1	06001005	30,56	06005005	36,70
1 1/4"	15 1	06001006	42,12	06005006	50,65
1 1/2"	10 1	06001007	49,81	06005007	59,87
2"	6 1			06005008	91,38



85 UNIÃO DE CRUZAMENTO

Ø	Imagem	NEGRO		GALVANIZADO	
		COD.	€	COD.	€
3/8"	100 10	08501002	4,04	08505002	4,89
1/2"	60 10	08501003	3,35	08505003	4,05
3/4"	30 10	08501004	4,98	08505004	6,08
1"	20 1	08501005	11,25	08505005	13,82
1 1/4"	10 1	08501006	25,48	08505006	30,98



90R JOELHO REDUÇÃO 90°

ISO/EN A1

Ø	Imagem	NEGRO		GALVANIZADO	
		COD.	€	COD.	€
3/8"-1/4"	120 10	09001021	3,30	09005021	3,97
1/2"-1/4"	120 10	09001031	4,72	09005031	5,67
1/2"-3/8"	120 10	09001032	1,56	09005032	1,87
3/4"-3/8"	90 10	09001042	2,20	09005042	2,65
3/4"-1/2"	90 10	09001043	1,53	09005043	1,83
1"-1/2"	50 10	09001053	2,65	09005053	3,22
1"-3/4"	50 10	09001054	2,63	09005054	3,20
1 1/4"-1/2"	50 10	09001063	7,22	09005063	8,26
1 1/4"-3/4"	50 10	09001064	5,47	09005064	6,64
1 1/4"-1"	40 1	09001065	4,39	09005065	5,36
1 1/2"-3/4"	30 1	09001074	8,71	09005074	10,51
1 1/2"-1"	35 1	09001075	6,65	09005075	8,05
1 1/2"-1 1/4"	25 1	09001076	5,57	09005076	8,00
2"-1"	15 1	09001085	14,36	09005085	17,24
2"-1 1/4"	15 1	09001086	10,75	09005086	12,95
2"-1 1/2"	15 1	09001087	10,79	09005087	13,05
2 1/2"-2"	8 1			09005098	42,54



92R JOELHO DE REDUÇÃO 90°

ISO/EN A4

Ø	Imagem	NEGRO		GALVANIZADO	
		COD.	€	COD.	€
1/2" x 3/8"	150 10	09201032	4,40	09205032	5,28
3/4" x 1/2"	90 10	09201043	4,89	09205043	5,96
1" x 3/4"	60 10	09201054	4,85	09205054	5,06
1 1/4" x 1"	30 1	09201065	9,49	09205065	11,37
1 1/2" x 1"	20 1	09201075	19,57	09205075	23,74
1 1/2" x 1 1/4"	20 1	09201076	14,41	09205076	17,40
3/8" x 1/2"	150 10	09201023	3,08	09205023	3,20
1/2" x 3/4"	90 10	09201034	6,04	09205034	6,19
3/4" x 1"	60 10	09201045	9,00	09205045	10,82
1" x 1 1/4"	30 1	09201056	13,49	09205056	14,08



94 JOELHO MACHO 90°

Ø		NEGRO		GALVANIZADO	
		COD.	€	COD.	€
3/8"	200 10	09401002	5,07	09405002	6,13
1/2"	150 10	09401003	5,20	09405003	6,29
3/4"	90 10	09401004	5,87	09405004	7,08
1"	60 10	09401005	9,22	09405005	11,17
1 1/4"	20 1	09401006	13,66	09405006	16,53
1 1/2"	25 1	09401007	24,70	09405007	29,89
2"	10 1	09401008	27,30	09405008	33,03



95 JOELHO C/JUNÇÃO S/D FÊMEA

ISO/EN UA1

Ø		NEGRO		GALVANIZADO	
		COD.	€	COD.	€
3/8"	70 10	09501002	9,36	09505002	11,25
1/2"	50 10	09501003	5,99	09505003	7,68
3/4"	40 10	09501004	6,52	09505004	8,28
1"	28 1	09501005	8,18	09505005	10,48
1 1/4"	14 1	09501006	14,00	09505006	18,01
1 1/2"	10 1	09501007	19,40	09505007	24,86
2"	6 1	09501008	28,90	09505008	37,08



96 JOELHO C/JUNÇÃO S/C FÊMEA

ISO/EN UA11

Ø		NEGRO		GALVANIZADO	
		COD.	€	COD.	€
1/4"	120 10	09601001	10,43	09605001	12,57
3/8"	80 10	09601002	7,91	09605002	9,73
1/2"	50 10	09601003	6,16	09605003	7,94
3/4"	40 10	09601004	7,10	09605004	9,12
1"	28 1	09601005	10,29	09605005	13,19
1 1/4"	14 1	09601006	17,25	09605006	22,15
1 1/2"	10 1	09601007	20,17	09605007	25,84
2"	6 1	09601008	34,22	09605008	43,92
2 1/2"	4 1	09601009	26,29	09605009	34,40
3"	2 1	0960100A	109,74	0960500A	143,76



97 JOELHO C/JUNÇÃO S/D M/F

ISO/EN UA2

Ø		NEGRO		GALVANIZADO	
		COD.	€	COD.	€
3/8"	70 10	09701002	9,36	09705002	11,25
1/2"	50 10	09701003	6,11	09705003	7,82
3/4"	30 10	09701004	7,25	09705004	9,27
1"	23 1	09701005	9,35	09705005	11,95
1 1/4"	12 1	09701006	16,09	09705006	20,62
1 1/2"	10 1	09701007	21,33	09705007	27,36
2"	6 1	09701008	31,22	09705008	40,00



98 JOELHO C/JUNÇÃO S/C M/F

ISO/EN UA12

Ø		NEGRO		GALVANIZADO	
		COD.	€	COD.	€
1/4"	120 10	09801001	9,56	09805001	11,63
3/8"	80 10	09801002	7,91	09805002	9,73
1/2"	50 10	09801003	5,99	09805003	7,68
3/4"	30 10	09801004	7,58	09805004	9,73
1"	23 1	09801005	10,42	09805005	13,28
1 1/4"	12 1	09801006	17,23	09805006	22,08
1 1/2"	10 1	09801007	21,30	09805007	27,28
2"	6 1	09801008	34,52	09805008	44,30
2 1/2"	3 1	09801009	91,77	09805009	120,19
3"	2 1	0980100A	118,65	0980500A	155,40



120 JOELHO SIMPLES 45°

ISO/EN A1/45°

Ø		NEGRO		GALVANIZADO	
		COD.	€	COD.	€
3/8"	150 10	12001002	3,91	12005002	4,68
1/2"	150 10	12001003	2,84	12005003	3,63
3/4"	90 10	12001004	3,60	12005004	4,58
1"	60 10	12001005	5,32	12005005	6,83
1 1/4"	30 1	12001006	11,47	12005006	14,08
1 1/2"	25 1	12001007	14,17	12005007	17,20
2"	10 1	12001008	18,49	12005008	22,51
2 1/2"	8 1	12001009	26,01	12005009	32,50
3"	5 1	1200100A	44,22	1200500A	55,91



130 TÊ SIMPLES

ISO/EN B1

Ø		NEGRO		GALVANIZADO	
		COD.	€	COD.	€
1/8"	200 10	13001000	2,79	13005000	3,39
1/4"	220 10	13001001	2,75	13005001	3,36
3/8"	120 10	13001002	1,77	13005002	2,09
1/2"	70 10	13001003	1,41	13005003	1,46
3/4"	60 10	13001004	1,93	13005004	2,07
1"	30 10	13001005	2,71	13005005	2,88
1 1/4"	20 1	13001006	4,72	13005006	5,21
1 1/2"	14 1	13001007	6,58	13005007	6,97
2"	10 1	13001008	9,64	13005008	10,26
2 1/2"	5 1	13001009	22,13	13005009	27,42
3"	4 1	1300100A	29,85	1300500A	39,42
4"	2 1	1300100C	51,28	1300500C	64,58
5"	2 1			1300500D	265,44
6"	1			1300500E	358,49



121 JOELHO SIMPLES M/F 45°

ISO/EN A4/45°

Ø		NEGRO		GALVANIZADO	
		COD.	€	COD.	€
3/8"	200 10	12101002	3,29	12105002	3,99
1/2"	150 10	12101003	2,98	12105003	3,80
3/4"	100 10	12101004	3,45	12105004	4,37
1"	50 10	12101005	5,37	12105005	6,89
1 1/4"	30 1	12101006	11,80	12105006	14,46
1 1/2"	25 1	12101007	12,85	12105007	15,63
2"	12 1	12101008	16,31	12105008	19,79
2 1/2"	8 1	12101009	31,80	12105009	38,76
3"	5 1	1210100A	48,10	1210500A	58,51

3



130R TÊ DE REDUÇÃO 90°

ISO/EN B1

Ø	150 10	NEGRO		GALVANIZADO	
		COD.	€	COD.	€
3/8"-1/4"-3/8"	150 10	13001212	4,54	13005212	5,51
3/8"-1/2"-3/8"	120 10	13001232	3,15	13005232	3,83
3/8"-3/4"-3/8"	90 10	13001242	4,32	13005242	5,78
1/2"-1/4"-1/2"	110 10	13001313	3,53	13005313	4,38
1/2"-3/8"-3/8"	110 10	13001322	3,02	13005322	3,65
1/2"-3/8"-1/2"	110 10	13001323	2,28	13005323	2,73
1/2"-1/2"-3/8"	110 10	13001332	3,02	13005332	3,65
1/2"-3/4"-3/8"	70 10	13001342	4,85	13005342	5,89
1/2"-3/4"-1/2"	70 10	13001343	2,51	13005343	3,01
1/2"-1"-1/2"	60 10	13001353	6,70	13005353	8,12
3/4"-1/4"-3/4"	70 10	13001414	4,85	13005414	5,88
3/4"-3/8"-1/2"	70 10	13001423	4,06	13005423	4,93
3/4"-3/8"-3/4"	70 10	13001424	2,36	13005424	2,85
3/4"-1/2"-3/8"	70 10	13001432	6,04	13005432	7,35
3/4"-1/2"-1/2"	70 10	13001433	2,59	13005433	3,13
3/4"-1/2"-3/4"	60 10	13001434	1,83	13005434	2,21
3/4"-3/4"-3/8"	60 10	13001442	4,36	13005442	5,27
3/4"-3/4"-1/2"	60 10	13001443	2,92	13005443	3,53
3/4"-1"-1/2"	50 10	13001453	5,82	13005453	7,07
3/4"-1"-3/4"	40 10	13001454	4,21	13005454	5,11
3/4"-1 1/4"-3/4"	35 1	13001464	8,87	13005464	10,81
1"-1/4"-1"	40 10	13001515	9,14	13005515	11,13
1"-3/8"-3/4"	50 10	13001524	5,45	13005524	6,61
1"-3/8"-1"	50 10	13001525	3,36	13005525	4,05
1"-1/2"-1/2"	50 10	13001533	5,60	13005533	6,82
1"-1/2"-3/4"	50 10	13001534	3,66	13005534	4,44
1"-1/2"-1"	40 10	13001535	3,13	13005535	3,82
1"-3/4"-1/2"	40 10	13001543	4,58	13005543	5,52
1"-3/4"-3/4"	40 10	13001544	3,86	13005544	4,66
1"-3/4"-1"	40 10	13001545	3,36	13005545	4,06
1"-1"-3/8"	40 10	13001552	6,33	13005552	7,69
1"-1"-1/2"	40 10	13001553	4,66	13005553	5,65
1"-1"-3/4"	30 10	13001554	4,44	13005554	5,87
1"-1 1/4"-3/4"	30 1	13001564	10,15	13005564	12,24
1"-1 1/4"-1"	30 1	13001565	8,11	13005565	9,89
1"-1 1/2"-1"	22 1	13001575	10,59	13005575	12,85
1 1/4"-3/8"-1 1/4"	30 1	13001626	6,01	13005626	7,30
1 1/4"-1/2"-1"	35 1	13001635	6,24	13005635	7,60
1 1/4"-1/2"-1 1/4"	30 1	13001636	5,67	13005636	6,90
1 1/4"-3/4"-3/4"	35 1	13001644	7,88	13005644	9,58
1 1/4"-3/4"-1"	32 1	13001645	7,51	13005645	8,95
1 1/4"-3/4"-1 1/4"	30 1	13001646	5,54	13005646	6,74
1 1/4"-1"-3/8"	30 1	13001652	10,04	13005652	12,18
1 1/4"-1"-1/2"	32 1	13001653	8,48	13005653	10,28
1 1/4"-1"-3/4"	30 1	13001654	8,29	13005654	10,05
1 1/4"-1"-1"	28 1	13001655	6,91	13005655	8,37
1 1/4"-1"-1 1/4"	25 1	13001656	5,47	13005656	6,64
1 1/4"-1 1/4"-1/2"	30 1	13001663	8,11	13005663	9,89
1 1/4"-1 1/4"-3/4"	25 1	13001664	9,56	13005664	11,62
1 1/4"-1 1/4"-1"	25 1	13001665	8,11	13005665	10,35
1 1/4"-1 1/2"-1"	20 1	13001675	12,16	13005675	14,77
1 1/4"-1 1/2"-1 1/4"	18 1	13001676	10,66	13005676	12,98
1 1/4"-2"-1 1/4"	10 1	13001686	16,17	13005686	19,62
1 1/2"-3/8"-1 1/2"	28 1	13001727	10,15	13005727	12,47
1 1/2"-1/2"-1 1/4"	28 1	13001736	7,75	13005736	9,42
1 1/2"-1/2"-1 1/2"	25 1	13001737	7,34	13005737	8,95
1 1/2"-3/4"-1 1/4"	25 1	13001746	10,59	13005746	12,91
1 1/2"-3/4"-1 1/2"	22 1	13001747	7,81	13005747	9,51

Ø	25 1	NEGRO		GALVANIZADO	
		COD.	€	COD.	€
1 1/2"-1"-1"	25 1	13001755	9,37	13005755	11,40
1 1/2"-1"-1 1/4"	22 1	13001756	9,37	13005756	11,40
1 1/2"-1"-1 1/2"	20 1	13001757	7,16	13005757	8,68
1 1/2"-1 1/4"-1"	15 1	13001765	14,17	13005765	17,24
1 1/2"-1 1/4"-1 1/4"	18 1	13001766	11,03	13005766	13,35
1 1/2"-1 1/4"-1 1/2"	17 1	13001767	10,09	13005767	12,24
1 1/2"-1 1/2"-1/2"	17 1	13001773	13,47	13005773	16,40
1 1/2"-1 1/2"-3/4"	17 1	13001774	12,60	13005774	15,27
1 1/2"-1 1/2"-1"	17 1	13001775	11,56	13005775	14,04
1 1/2"-1 1/2"-1 1/4"	15 1	13001776	13,47	13005776	16,40
1 1/2"-2"-1 1/4"	10 1	13001786	17,68	13005786	19,69
1 1/2"-2"-1 1/2"	10 1	13001787	15,47	13005787	18,79
2"-1/2"-1 1/2"	18 1	13001837	15,47	13005837	18,79
2"-1/2"-2"	15 1	13001838	10,11	13005838	12,31
2"-3/4"-1 1/2"	16 1	13001847	13,70	13005847	16,62
2"-3/4"-2"	15 1	13001848	11,96	13005848	14,56
2"-1"-1 1/2"	15 1	13001857	13,70	13005857	16,62
2"-1"-2"	12 1	13001858	10,11	13005858	12,32
2"-1 1/4"-1"	12 1	13001865	19,88	13005865	24,22
2"-1 1/4"-1 1/4"	12 1	13001866	14,20	13005866	17,30
2"-1 1/4"-1 1/2"	12 1	13001867	14,20	13005867	17,30
2"-1 1/4"-2"	12 1	13001868	11,98	13005868	14,57
2"-1 1/2"-1"	12 1	13001875	19,88	13005875	24,22
2"-1 1/2"-1 1/2"	10 1	13001877	15,64	13005877	19,03
2"-1 1/2"-2"	10 1	13001878	13,71	13005878	16,70
2"-2"-1/2"	10 1	13001883	28,34	13005883	34,40
2"-2"-3/4"	10 1	13001884	18,06	13005884	22,03
2"-2"-1"	10 1	13001885	16,35	13005885	19,88
2"-2"-1 1/4"	10 1	13001886	19,75	13005886	24,00
2"-2"-1 1/2"	10 1	13001887	16,56	13005887	20,14
2"-2 1/2"-2"	6 1	13001898	42,08	13005898	51,20
2 1/2"-1/2"-2 1/2"	8 1	13001939	42,33	13005939	51,60
2 1/2"-3/4"-2 1/2"	8 1	13001949	29,82	13005949	34,66
2 1/2"-1"-2 1/2"	8 1	13001959	21,48	13005959	29,93
2 1/2"-1 1/4"-2 1/2"	8 1	13001969	26,52	13005969	33,75
2 1/2"-1 1/2"-2 1/2"	8 1	13001979	25,66	13005979	35,78
2 1/2"-2"-2"	6 1	13001988	47,30	13005988	60,23
2 1/2"-2"-2 1/2"	6 1	13001989	27,43	13005989	38,30
2 1/2"-2 1/2"-1 1/2"	6 1			13005997	72,22
2 1/2"-2 1/2"-2	6 1			13005998	58,48
3"-1/2"-3"	5 1			13005A3A	45,83
3"-3/4"-3"	6 1			13005A4A	47,75
3"-1"-3"	5 1	13001A5A	35,58	13005A5A	49,60
3"-1 1/4"-3"	4 1	13001A6A	38,10	13005A6A	48,53
3"-1 1/2"-3"	4 1	13001A7A	38,51	13005A7A	53,65
3"-2"-2"	4 1			13005A88	58,59
3"-2"-3"	4 1	13001A8A	38,97	13005A8A	61,39
3"-2 1/2"-3"	3 1	13001A9A	49,55	13005A9A	69,07
3"-3"-2"	2 1			13005AA8	92,32
4"-1/2"-4"	2 1	13001C3C	94,47		
4"-3/4"-4"	2 1	13001C4C	94,47	13005C4C	120,23
4"-1"-4"	2 1	13001C5C	94,47	13005C5C	120,23
4"-1 1/2"-4"	2 1	13001C7C	56,70	13005C7C	72,13
4"-2"-4"	2 1	13001C8C	72,32	13005C8C	88,04
4"-2 1/2"-4"	2 1	13001C9C	76,30	13005C9C	92,74
4"-3"-4"	2 1	13001CAC	74,22	13005CAC	94,44
5"-4"-5"	2 1			13005DCD	269,43



131 TÊ C/ RAMAL CURVO 90°

ISO/EN **E1**

Ø		NEGRO		GALVANIZADO	
		COD.	€	COD.	€
1/2"	50 10	13101003	5,60	13105003	6,95
3/4"	40 10	13101004	7,15	13105004	8,79
1"	20 10	13101005	10,80	13105005	13,33
1 1/4"	14 1	13101006	14,69	13105006	18,08
1 1/2"	8 1	13101007	21,80	13105007	26,44
2"	4 1	13101008	30,90	13105008	38,19
2 1/2"	2 1	13101009	62,07	13105009	75,59
3"	2 1	1310100A	74,14	1310500A	90,42
4"	2 1	1310100C	175,55	1310500C	231,45



132 TÊ DE 2 CURVAS

ISO/EN **E2**

Ø		NEGRO		GALVANIZADO	
		COD.	€	COD.	€
1/2"	40 1	13201003	10,34	13205003	12,59
3/4"	25 1	13201004	11,42	13205004	13,85
1"	15 1	13201005	18,09	13205005	22,09
1 1/4"	10 1	13201006	31,21	13205006	38,15
1 1/2"	8 1	13201007	39,50	13205007	48,12
2"	3 1	13201008	50,32	13205008	61,55



133 TÊ 90° F/M/F

Ø		NEGRO		GALVANIZADO	
		COD.	€	COD.	€
3/8"	150 10	13301002	7,12	13305002	8,68
1/2"	80 10	13301003	5,70	13305003	6,93
3/4"	50 10	13301004	8,64	13305004	10,53
1"	15 1	13301005	14,48	13305005	17,80



134 TÊ 90° F/F/M

Ø		NEGRO		GALVANIZADO	
		COD.	€	COD.	€
1/2"	80 10	13401003	6,57	13405003	7,99
3/4"	50 10	13401004	8,90	13405004	10,82
1"	30 1	13401005	12,70	13405005	15,31
1 1/4"	20 1	13401006	19,90	13405006	24,18
1 1/2"	15 1	13401007	24,40	13405007	29,56
2"	8 1	13401008	38,44	13405008	46,67



135 TÊ 90° MACHO

Ø		NEGRO		GALVANIZADO	
		COD.	€	COD.	€
1/2"	100 10	13501003	10,13	13505003	12,44
3/4"	60 1	13501004	12,40	13505004	15,21
1"	40 1	13501005	16,33	13505005	19,84



165 FORQUILHA 45°

Ø		NEGRO		GALVANIZADO	
		COD.	€	COD.	€
1/2"	50 10	16501003	8,69	16505003	10,51
3/4"	30 10	16501004	10,02	16505004	12,08
1"	20 1	16501005	14,94	16505005	18,10
1 1/4"	10 1	16501006	18,45	16505006	22,45
1 1/2"	6 1	16501007	24,83	16505007	30,15
2"	4 1	16501008	37,00	16505008	44,99



180 CRUZETA

ISO/EN **C1**

Ø		NEGRO		GALVANIZADO	
		COD.	€	COD.	€
1/4"	120 10	18001001	6,05	18005001	7,33
3/8"	100 10	18001002	4,85	18005002	5,77
1/2"	70 10	18001003	3,30	18005003	3,88
3/4"	40 10	18001004	5,01	18005004	5,91
1"	28 1	18001005	6,91	18005005	8,19
1 1/4"	16 1	18001006	9,26	18005006	10,99
1 1/2"	10 1	18001007	13,77	18005007	16,30
2"	7 1	18001008	21,16	18005008	25,06
2 1/2"	3 1	18001009	31,25	18005009	43,11
3"	2 1	1800100A	41,71	1800500A	52,51
4"	1	1800100C	75,73	1800500C	95,31



220 FORQUILHA FISGA

Ø		NEGRO		GALVANIZADO	
		COD.	€	COD.	€
3/8"	100 10	22001002	6,97	22005002	8,37
1/2"	60 10	22001003	6,03	22005003	7,18
3/4"	40 10	22001004	9,36	22005004	11,32
1"	20 1	22001005	15,51	22005005	18,77



221 JOELHO DE 3 VIAS

ISO/EN **Za1**

Ø	Cód. Caixa	NEGRO		GALVANIZADO	
		COD.	€	COD.	€
3/8"	120 10	22101002	5,68	22105002	4,23
1/2"	80 10	22101003	3,42	22105003	4,09
3/4"	50 10	22101004	3,88	22105004	4,66
1"	40 10	22101005	7,75	22105005	9,30
1 1/4"	20 1	22101006	11,90	22105006	15,23
1 1/2"	13 1	22101007	18,33	22105007	23,49
2"	8 1	22101008	26,52	22105008	33,98



223 TÊ 4 VIAS

ISO/EN **Za2**

Ø	Cód. Caixa	NEGRO		GALVANIZADO	
		COD.	€	COD.	€
1/2"	60 1	22301003	6,62	22305003	7,99
3/4"	40 1	22301004	8,35	22305004	10,04
1"	25 1	22301005	12,33	22305005	14,93

2



240 UNIÃO DE REDUÇÃO

ISO/EN **M2**

Ø	Cód. Caixa	NEGRO		GALVANIZADO	
		COD.	€	COD.	€
1/4" - 1/8"	400 10	24011010	4,31	24015010	4,50
3/8" - 1/8"	400 10	24011020	2,08	24015020	2,53
3/8" - 1/4"	400 10	24011021	1,66	24015021	2,63
1/2" - 1/4"	150 10	24001031	2,14	24005031	2,67
1/2" - 3/8"	200 10	24001032	1,74	24005032	2,10
3/4" - 1/4"	140 10	24001041	2,94	24005041	3,51
3/4" - 3/8"	140 10	24001042	2,10	24005042	2,59
3/4" - 1/2"	140 10	24001043	1,73	24005043	2,10
1" - 3/8"	100 10	24001052	3,39	24005052	4,13
1" - 1/2"	90 10	24001053	2,19	24005053	2,65
1" - 3/4"	80 10	24001054	2,08	24005054	2,53
1 1/4" - 3/8"	60 10	24001062	4,84	24005062	5,95
1 1/4" - 1/2"	60 10	24001063	3,58	24005063	4,36
1 1/4" - 3/4"	60 10	24001064	3,42	24005064	4,15
1 1/4" - 1"	50 10	24001065	3,60	24005065	4,42
1 1/2" - 1/2"	50 1	24001073	5,47	24005073	6,73
1 1/2" - 3/4"	50 1	24001074	5,00	24005074	6,10
1 1/2" - 1"	45 1	24001075	4,04	24005075	4,96
1 1/2" - 1 1/4"	40 1	24001076	4,52	24005076	5,52
2" - 1/2"	30 1	24001083	8,49	24005083	10,34
2" - 3/4"	30 1	24001084	8,52	24005084	10,45
2" - 1"	25 1	24001085	7,84	24005085	9,60
2" - 1 1/4"	22 1	24001086	7,06	24005086	8,60
2" - 1 1/2"	22 1	24001087	5,75	24005087	7,07
2 1/2" - 1"	16 1	24001095	21,05	24005095	25,58
2 1/2" - 1 1/4"	14 1	24001096	23,28	24005096	28,31
2 1/2" - 1 1/2"	14 1	24001097	13,73	24005097	17,50
2 1/2" - 2"	10 1	24001098	20,31	24005098	25,83
3" - 1 1/4"	10 1	240010A6	26,24	240050A6	33,36
3" - 1 1/2"	10 1	240010A7	26,24	240050A7	33,36
3" - 2"	10 1	240010A8	28,61	240050A8	36,43
3" - 2 1/2"	8 1	240010A9	29,74	240050A9	37,82
4" - 2"	6 1	240010C8	52,34	240050C8	66,61
4" - 2 1/2"	6 1	240010C9	30,64	240050C9	38,96
4" - 3"	6 1	240010CA	30,64	240050CA	38,96



TIPO I



TIPO II



TIPO III

241 PORCA DE REDUÇÃO M/F

ISO/EN **N4**

Ø	TIPO	Cód. Caixa	NEGRO		GALVANIZADO	
			COD.	€	COD.	€
1/4"-1/8"	I	400 10	24111010	1,40	24115010	1,70
3/8"-1/8"	II	400 10	24111020	1,38	24115020	1,68
3/8"-1/4"	I	400 10	24111021	1,91	24115021	1,98
1/2"-1/8"	II	400 10	24111030	1,73	24115030	1,78
1/2"-1/4"	II	350 10	24101031	1,07	24105031	1,29
1/2"-3/8"	I	350 10	24101032	0,97	24105032	1,16
3/4"-1/4"	II	200 10	24101041	1,71	24105041	2,07
3/4"-3/8"	II	200 10	24101042	1,25	24105042	1,53
3/4"-1/2"	I	200 10	24101043	0,79	24105043	0,94
1"-1/4"	II	140 10	24101051	2,84	24105051	3,46
1"-3/8"	II	140 10	24101052	2,23	24105052	2,68
1"-1/2"	II	140 10	24101053	1,54	24105053	1,83
1"-3/4"	I	140 10	24101054	1,54	24105054	1,83
1 1/4"-3/8"	II	80 10	24101062	3,66	24105062	4,44
1 1/4"-1/2"	II	80 10	24101063	2,54	24105063	3,07
1 1/4"-3/4"	II	80 10	24101064	2,37	24105064	2,90
1 1/4"-1"	I	80 10	24101065	2,02	24105065	2,43
1 1/2"-3/8"	II	80 10	24101072	5,59	24105072	6,75
1 1/2"-1/2"	II	70 10	24101073	3,32	24105073	4,00
1 1/2"-3/4"	II	70 10	24101074	3,58	24105074	4,31
1 1/2"-1"	II	70 10	24101075	2,81	24105075	3,42
1 1/2"-1 1/4"	I	70 10	24101076	2,81	24105076	3,42
2"-1/2"	III	30 1	24101083	6,57	24105083	8,07
2"-3/4"	III	30 1	24101084	6,24	24105084	7,56
2"-1"	II	30 1	24101085	4,59	24105085	5,59
2"-1 1/4"	II	30 1	24101086	5,18	24105086	6,31
2"-1 1/2"	II	30 1	24101087	4,58	24105087	5,53
2 1/2"-2"	II	20 1	24101095	10,47	24105095	13,35
2 1/2"-1 1/4"	III	20 1	24101096	12,14	24105096	15,47
2 1/2"-1 1/2"	II	20 1	24101097	11,67	24105097	14,84
2 1/2"-2"	II	20 1	24101098	8,86	24105098	11,27
3"-1"	III	10 1	241010A5	16,36	241050A5	19,95
3"-1 1/4"	III	10 1	241010A6	18,09	241050A6	22,02
3"-1 1/2"	III	10 1	241010A7	17,00	241050A7	20,68
3"-2"	II	15 1	241010A8	13,25	241050A8	16,86
3"-2 1/2"	II	15 1	241010A9	14,27	241050A9	18,18
4"-2"	III	8 1	241010C8	33,27	241050C8	40,45
4"-2 1/2"	III	8 1	241010C9	32,46	241050C9	39,51
4"-3"	II	8 1	241010CA	24,68	241050CA	31,50
5"-4"	II	11 1			241050DC	163,05
6"-4"	III	6 1			241050EC	217,56
6"-5"	II	6 1			241050ED	236,59



245 CASQ. DUPLO REDUÇÃO

ISO/EN **N8**

Ø		NEGRO		GALVANIZADO	
		COD.	€	COD.	€
1/4"-1/8"	400 10	24511010	1,36	24515010	1,62
3/8"-1/8"	400 10	24511020	2,67	24515020	3,74
3/8"-1/4"	400 10	24511021	1,78	24515021	2,07
1/2"-1/4"	250 10	24511031	1,74	24515031	2,13
1/2"-3/8"	230 10	24501032	1,77	24505032	2,10
3/4"-1/4"	150 10	24501041	2,73	24505041	3,36
3/4"-3/8"	140 10	24501042	2,56	24505042	3,09
3/4"-1/2"	150 10	24501043	2,02	24505043	2,44
1"-1/2"	100 10	24501053	2,88	24505053	3,45
1"-3/4"	100 10	24501054	2,25	24505054	2,73
1 1/4"-1/2"	60 10	24501063	6,03	24505063	7,33
1 1/4"-3/4"	60 10	24501064	4,82	24505064	5,84
1 1/4"-1"	50 10	24501065	3,82	24505065	4,65
1 1/2"-3/4"	50 1	24501074	4,97	24505074	6,04
1 1/2"-1"	50 1	24501075	7,69	24505075	9,38
1 1/2"-1 1/4"	45 1	24501076	4,51	24505076	5,50
2"-1"	25 1	24501085	7,75	24505085	9,43
2"-1 1/4"	25 1	24501086	8,84	24505086	10,72
2"-1 1/2"	25 1	24501087	7,74	24505087	9,41
2 1/2"-1 1/2"	15 1	24501097	14,02	24505097	16,93
2 1/2"-2"	14 1	24501098	19,14	24505098	23,30
3"-2"	8 1	245010A8	28,54	245050A8	34,71
3"-2 1/2"	8 1	245010A9	30,85	245050A9	38,39
4"-3"	4 1	245010CA	63,80	245050CA	77,20



246 UNIÃO M/F REDUÇÃO

ISO/EN **M4**

Ø		NEGRO		GALVANIZADO	
		COD.	€	COD.	€
1/4"-1/8"	400 10	24611010	2,44	24615010	2,92
3/8"-1/4"	400 10	24611021	2,51	24615021	3,02
1/2"-1/4"	220 10	24601031	2,45	24605031	2,97
1/2"-3/8"	220 10	24601032	1,73	24605032	2,09
3/4"-3/8"	150 10	24601042	3,02	24605042	3,65
3/4"-1/2"	140 10	24601043	2,05	24605043	2,47
1"-1/2"	80 10	24601053	3,01	24605053	3,65
1"-3/4"	80 10	24601054	4,06	24605054	4,24
1 1/4"-1/2"	60 10	24601063	7,43	24605063	8,99
1 1/4"-3/4"	50 10	24601064	5,23	24605064	6,41
1 1/4"-1"	50 10	24601065	4,34	24605065	5,23
1 1/2"-3/4"	45 1	24601074	6,73	24605074	8,13
1 1/2"-1"	45 1	24601075	6,24	24605075	7,56
1 1/2"-1 1/4"	40 1	24601076	5,59	24605076	8,42
2"-1"	30 1	24601085	10,32	24605085	12,54
2"-1 1/4"	25 1	24601086	8,82	24605086	10,71
2"-1 1/2"	20 1	24601087	9,13	24605087	11,11
2 1/2"-1 1/2"	12 1	24601097	23,54	24605097	28,62
2 1/2"-2"	12 1	24601098	18,61	24605098	22,54
3"-2"	12 1	246010A8	27,11	246050A8	32,91
3"-2 1/2"	12 1	246010A9	33,11	246050A9	40,28



270 UNIÃO SIMPLES

ISO/EN **M2**

Ø		NEGRO		GALVANIZADO	
		COD.	€	COD.	€
1/8"	400 10	27011000	1,40	27015000	1,71
1/4"	400 10	27011001	1,40	27015001	1,71
3/8"	250 10	27001002	1,23	27005002	1,41
1/2"	180 10	27001003	0,97	27005003	0,99
3/4"	110 10	27001004	1,15	27005004	1,16
1"	80 10	27001005	1,79	27005005	1,85
1 1/4"	45 1	27001006	2,97	27005006	3,11
1 1/2"	35 1	27001007	3,96	27005007	4,19
2"	20 1	27001008	6,10	27005008	6,46
2 1/2"	12 1	27001009	10,96	27005009	13,19
3"	9 1	2700100A	19,93	2700500A	25,16
4"	4 1	2700100C	31,48	2700500C	39,73
5"	3 1			2700500D	201,43
6"	3 1			2700500E	274,97



271 UNIÃO C/ ROSCA DIR./ESQ.

ISO/EN **M2 R-L**

Ø		NEGRO		GALVANIZADO	
		COD.	€	COD.	€
3/8"	250 10	27101002	1,66	27105002	2,00
1/2"	180 10	27101003	1,63	27105003	2,08
3/4"	110 10	27101004	2,10	27105004	2,73
1"	80 10	27101005	2,54	27105005	3,29
1 1/4"	45 1	27101006	4,84	27105006	6,20
1 1/2"	35 1	27101007	5,45	27105007	7,02
2"	20 1	27101008	9,92	27105008	12,71



280 CASQUILHO DUPLO

ISO/EN N8

Ø	Box	NEGRO		GALVANIZADO	
		COD.	€	COD.	€
1/8"	400 10	28011000	1,79	28015000	2,14
1/4"	400 10	28011001	1,87	28015001	2,22
3/8"	300 10	28001002	1,53	28005002	1,79
1/2"	200 10	28001003	1,01	28005003	1,02
3/4"	130 10	28001004	1,10	28005004	1,16
1"	80 10	28001005	1,59	28005005	1,63
1 1/4"	40 10	28001006	2,97	28005006	3,11
1 1/2"	40 1	28001007	3,42	28005007	3,78
2"	20 1	28001008	5,83	28005008	6,52
2 1/2"	10 1	28001009	10,44	28005009	13,75
3"	8 1	2800100A	15,11	2800500A	19,91
4"	4 1	2800100C	29,34	2800500C	36,93
5"	3 1			2800500D	142,95
6"	3 1			2800500E	273,88



281 CASQUILHO DUPLO C/ROSCA DIR./ESQ.

ISO/EN N8 R-L

Ø	Box	NEGRO		GALVANIZADO	
		COD.	€	COD.	€
3/8"	300 10	28101002	3,29	28105002	3,97
1/2"	200 10	28101003	2,06	28105003	2,62
3/4"	130 10	28101004	2,38	28105004	3,02
1"	80 10	28101005	3,31	28105005	4,21
1 1/4"	40 10	28101006	4,84	28105006	6,14
1 1/2"	40 1	28101007	6,67	28105007	8,61
2"	20 1	28101008	9,82	28105008	12,54



290 TAMPÃO MACHO (TACO)

ISO/EN T9

Ø	Box	NEGRO		GALVANIZADO	
		COD.	€	COD.	€
1/8"	400 10	29011000	1,05	29015000	1,29
1/4"	400 10	29011001	0,99	29015001	1,22
3/8"	400 10	29001002	0,79	29005002	0,94
1/2"	300 10	29001003	0,71	29005003	0,76
3/4"	200 10	29001004	0,89	29005004	0,99
1"	120 10	29001005	1,33	29005005	1,44
1 1/4"	80 10	29001006	1,92	29005006	2,13
1 1/2"	60 10	29001007	2,29	29005007	2,58
2"	40 1	29001008	3,54	29005008	4,00
2 1/2"	20 1	29001009	8,11	29005009	10,70
3"	15 1	2900100A	10,53	2900500A	13,88
4"	8 1	2900100C	20,80	2900500C	26,23



291 TAMPÃO MACHO (TACO) S/CORDÃO

ISO/EN T8

Ø	Box	NEGRO		GALVANIZADO	
		COD.	€	COD.	€
1/8"	400 10	29111000	1,18	29115000	1,35
1/4"	400 10	29111001	1,22	29115001	1,46
3/8"	400 10	29101002	1,22	29105002	1,46
1/2"	300 10	29101003	0,89	29105003	1,12
3/4"	200 10	29101004	1,16	29105004	1,39
1"	120 10	29101005	1,44	29105005	1,86
1 1/4"	80 10	29101006	2,25	29105006	2,84
1 1/2"	60 10	29101007	2,90	29105007	3,65
2"	40 1	29101008	4,36	29105008	5,55
2 1/2"	20 1	29101009	10,93	29105009	13,19
3"	15 1	2910100A	13,33	2910500A	16,12
4"	8 1	2910100C	46,28	2910500C	56,38



294 TAMPÃO MACHO (TACO) P/SELAR

Ø	Box	NEGRO		GALVANIZADO	
		COD.	€	COD.	€
1/2"	300 10	29401003	1,84	29405003	2,16
3/4"	200 10	29401004	2,30	29405004	2,74
1"	120 10	29401005	3,23	29405005	3,88
1 1/4"	80 10	29401006	3,74	29405006	4,50
1 1/2"	60 10	29401007	4,06	29405007	4,85
2"	40 1	29401008	5,69	29405008	6,82



300 TAMPÃO FÊMEA

ISO/EN T1

Ø	Box	NEGRO		GALVANIZADO	
		COD.	€	COD.	€
1/8"	400 10	30011000	1,17	30015000	1,43
1/4"	400 10	30011001	1,40	30015001	1,43
3/8"	400 10	30011002	1,01	30015002	1,22
1/2"	280 10	30001003	1,02	30005003	1,20
3/4"	180 10	30001004	1,15	30005004	1,31
1"	130 10	30001005	1,48	30005005	1,77
1 1/4"	80 10	30001006	2,47	30005006	2,88
1 1/2"	60 10	30001007	2,96	30005007	3,45
2"	40 1	30001008	5,15	30005008	6,05
2 1/2"	25 1	30001009	10,09	30005009	13,29
3"	15 1	3000100A	11,72	3000500A	15,42
4"	8 1	3000100C	23,87	3000500C	30,05

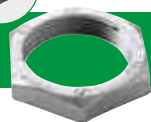

310 BATENTE

ISO/EN P4

Ø		NEGRO		GALVANIZADO	
		COD.	€	COD.	€
1/4"	400 10	31011001	2,25	31015001	3,11
3/8"	400 10	31011002	2,38	31015002	2,53
1/2"	400 10	31001003	1,24	31005003	1,50
3/4"	300 10	31001004	1,36	31005004	1,63
1"	200 10	31001005	1,55	31005005	2,01
1 1/4"	80 1	31001006	2,44	31005006	2,96
1 1/2"	70 1	31001007	2,73	31005007	3,31
2"	50 1	31001008	5,55	31005008	6,66
2 1/2"	25 1	31001009	11,67	31005009	14,17
3"	25 1	3100100A	13,63	3100500A	16,65

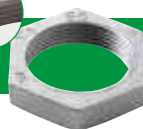

312 BATENTE REBAIXADO

ISO/EN P4

Ø		NEGRO		GALVANIZADO	
		COD.	€	COD.	€
1/4"	400 10	31211001	1,74	31215001	2,10
3/8"	400 10	31211002	1,74	31215002	2,10
1/2"	400 10	31201003	0,98	31205003	1,25
3/4"	300 10	31201004	2,40	31205004	2,71
1"	200 10	31201005	1,79	31205005	2,20
1 1/4"	120 10	31201006	1,81	31205006	2,29
1 1/2"	90 10	31201007	2,43	31205007	3,07
2"	60 10	31201008	4,38	31205008	5,60
2 1/2"	35 1	31201009	12,10	31205009	15,80
3"	25 1	3120100A	13,42	3120500A	17,60
4"	12 1	3120100C	19,31	3120500C	25,30



320 FLANGE OVAL

Ø		NEGRO		GALVANIZADO	
		COD.	€	COD.	€
1/2"	140 1	32001003	5,70	32005003	7,29
3/4"	110 1	32001004	6,90	32005004	8,86
1"	70 1	32001005	7,99	32005005	10,25
1 1/4"	50 1	32001006	10,30	32005006	13,17
1 1/2"	35 1	32001007	13,18	32005007	16,94
2"	30 1	32001008	15,94	32005008	20,40
2 1/2"	15 1	32001009	33,97	32005009	44,47
3"	10 1	3200100A	42,27	3200500A	55,35
4"	6 1	3200100C	47,38	3200500C	62,03



321 FLANGE NORMAL

Ø		NEGRO		GALVANIZADO	
		COD.	€	COD.	€
3/8"	110 1			32105002	13,83
1/2"	90 1	32101003	3,89	32105003	4,98
3/4"	70 1	32101004	5,18	32105004	6,61
1"	50 1	32101005	6,06	32105005	7,74
1 1/4"	30 1	32101006	8,18	32105006	10,47
1 1/2"	20 1	32101007	9,38	32105007	11,99
2"	15 1	32101008	11,40	32105008	14,58
2 1/2"	12 1	32101009	20,25	32105009	26,54
3"	9 1	3210100A	26,52	3210500A	34,71
4"	5 1	3210100C	48,28	3210500C	63,20

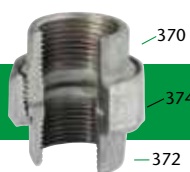

330 JUNÇÃO FÊMEA S/D

ISO/EN U1

Ø		NEGRO		GALVANIZADO	
		COD.	€	COD.	€
1/2"	80 10	33001003	3,69	33005003	4,68
3/4"	50 10	33001004	4,72	33005004	6,05
1"	30 10	33001005	5,53	33005005	7,10
1 1/4"	20 1	33001006	7,80	33005006	9,99
1 1/2"	18 1	33001007	10,52	33005007	13,42
2"	10 1	33001008	15,78	33005008	20,23
2 1/2"	7 1	33001009	39,08	33005009	51,15
3"	4 1	3300100A	62,34	3300500A	81,68
4"	2 1	3300100C	146,18	3300500C	191,45

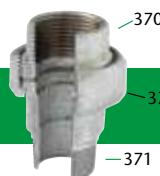

331 JUNÇÃO M/F S/D

ISO/EN U2

Ø		NEGRO		GALVANIZADO	
		COD.	€	COD.	€
3/8"	100 10	33101002	7,11	33105002	8,54
1/2"	60 10	33101003	5,22	33105003	6,69
3/4"	40 10	33101004	5,76	33105004	7,38
1"	35 1	33101005	7,30	33105005	9,36
1 1/4"	18 1	33101006	11,43	33105006	14,65
1 1/2"	15 1	33101007	13,64	33105007	17,50
2"	10 1	33101008	21,52	33105008	27,55
2 1/2"	4 1	33101009	56,67	33105009	74,19
3"	2 1	3310100A	91,45	3310500A	119,72

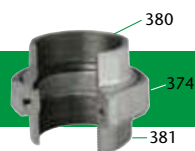

340 JUNÇÃO FÊMEA S/C

ISO/EN **U11**

Ø	Imagem	NEGRO		GALVANIZADO	
		COD.	€	COD.	€
1/8"	160 10	34001000	15,86	34005000	19,04
1/4"	140 10	34001001	6,80	34005001	8,31
3/8"	100 10	34001002	6,80	34005002	8,31
1/2"	80 10	34001003	3,58	34005003	4,42
3/4"	50 10	34001004	4,05	34005004	5,03
1"	30 10	34001005	5,04	34005005	6,23
1 1/4"	20 1	34001006	9,52	34005006	11,45
1 1/2"	18 1	34001007	11,80	34005007	14,23
2"	10 1	34001008	17,63	34005008	21,21
2 1/2"	7 1	34001009	37,50	34005009	49,12
3"	4 1	3400100A	56,66	3400500A	77,67
4"	2 1	3400100C	139,10	3400500C	182,14

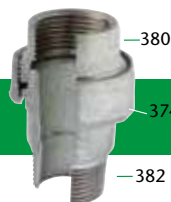

341 JUNÇÃO M/F S/C

ISO/EN **U12**

Ø	Imagem	NEGRO		GALVANIZADO	
		COD.	€	COD.	€
1/4"	120 10	34101001	6,98	34105001	8,56
3/8"	100 10	34101002	6,98	34105002	8,56
1/2"	60 10	34101003	6,97	34105003	8,90
3/4"	40 10	34101004	7,02	34105004	8,98
1"	35 1	34101005	8,66	34105005	11,11
1 1/4"	18 1	34101006	12,19	34105006	15,63
1 1/2"	15 1	34101007	15,56	34105007	19,95
2"	10 1	34101008	24,51	34105008	31,38
2 1/2"	4 1	34101009	62,40	34105009	85,57
3"	2 1	3410100A	100,67	3410500A	138,06
4"	1	3410100C	156,34	3410500C	204,71

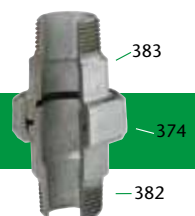

344 JUNÇÃO MACHO S/C

Ø	Imagem	NEGRO		GALVANIZADO	
		COD.	€	COD.	€
1/4"	120 10	34401001	13,19	34405001	15,84
3/8"	100 10	34401002	10,98	34405002	13,08
1/2"	50 10	34401003	10,02	34405003	12,25
3/4"	40 10	34401004	11,57	34405004	14,18
1"	30 1	34401005	15,21	34405005	17,31
1 1/4"	15 1	34401006	23,76	34405006	28,84
1 1/2"	10 1	34401007	26,61	34405007	32,37
2"	6 1	34401008	48,60	34405008	59,11



370 PEÇA DE JUNÇÃO

Ø	Imagem	NEGRO		GALVANIZADO	
		COD.	€	COD.	€
1/2"	250 1	37001003	2,21	37005003	2,76
3/4"	200 1	37001004	2,66	37005004	3,37
1"	120 1	37001005	3,17	37005005	4,03
1 1/4"	70 1	37001006	4,13	37005006	5,26
1 1/2"	50 1	37001007	5,55	37005007	7,15
2"	25 1	37001008	7,61	37005008	8,66
2 1/2"	15 1	37001009	9,75	37005009	12,01
3"	10 1	3700100A	15,61	3700500A	19,50
4"	6 1	3700100C	23,40	3700500C	29,90



371 PEÇA DE JUNÇÃO

Ø	Imagem	NEGRO		GALVANIZADO	
		COD.	€	COD.	€
1/2"	225 1	37101003	2,74	37105003	3,48
3/4"	125 1	37101004	3,39	37105004	4,28
1"	80 1	37101005	2,68	37105005	5,35
1 1/4"	45 1	37101006	5,03	37105006	5,76
1 1/2"	35 1	37101007	4,89	37105007	6,26
2"	20 1	37101008	6,75	37105008	13,31
2 1/2"	10 1	37101009	29,88	37105009	35,83
3"	6 1	3710100A	53,31	3710500A	63,99



372 PEÇA DE JUNÇÃO

Ø	Imagem	NEGRO		GALVANIZADO	
		COD.	€	COD.	€
1/2"	325 1	37201003	1,85	37205003	2,33
3/4"	210 1	37201004	2,27	37205004	2,90
1"	150 1	37201005	3,98	37205005	4,22
1 1/4"	80 1	37201006	3,86	37205006	6,76
1 1/2"	55 1	37201007	7,35	37205007	9,40
2"	30 1	37201008	9,90	37205008	10,76
2 1/2"	16 1	37201009	15,40	37205009	19,22
3"	10 1	3720100A	24,32	3720500A	29,13



374 BATENTE P/ JUNÇÃO

Ø	Imagem	NEGRO		GALVANIZADO	
		COD.	€	COD.	€
3/8"	300 1	37401002	1,75	37405002	2,09
1/2"	175 1	37401003	1,53	37405003	1,96
3/4"	140 1	37401004	1,89	37405004	2,43
1"	100 1	37401005	2,33	37405005	2,97
1 1/4"	55 1	37401006	3,06	37405006	3,89
1 1/2"	45 1	37401007	3,83	37405007	4,84
2"	30 1	37401008	5,36	37405008	6,88
2 1/2"	15 1	37401009	14,05	37405009	17,51
3"	12 1	3740100A	19,27	3740500A	23,29
4"	8 1	3740100C	23,40	3740500C	28,61



526 UNIÃO M/F ALONGAMENTO

Ø	Imagem	NEGRO		GALVANIZADO	
		COD.	€	COD.	€
30 x 3/8"	350 10	52601302	2,01	52605302	2,47
30 x 1/2"	220 10	52601303	1,78	52605303	2,28
40 x 3/8"	250 10	52601402	2,08	52605402	2,50
40 x 1/2"	200 10	52601403	1,81	52605403	2,29
40 x 3/4"	120 10	52601404	2,99	52605404	3,75
50 x 1/2"	120 10	52601503	2,51	52605503	3,09



531 ROSCA EXTERIOR (UNIÃO)

Ø	Imagem	NEGRO		GALVANIZADO	
		COD.	€	COD.	€
1/8"	100 10			53115000	1,31
1/4"	500 10	53111001	1,41	53115001	3,34
3/8"	400 10	53101002	1,41	53105002	1,75
1/2"	380 10	53101003	1,36	53105003	1,73
3/4"	240 10	53101004	1,56	53105004	2,00
1"	140 10	53101005	1,69	53105005	2,16
1 1/4"	80 10	53101006	2,68	53105006	3,44
1 1/2"	60 10	53101007	3,52	53105007	4,50
2"	35 1	53101008	5,31	53105008	6,83
2 1/2"	18 1	53101009	11,81	53105009	15,48
3"	12 1	5310100A	16,73	5310500A	22,94
4"	8 1	5310100C	28,57	5310500C	37,36

JUNTAS DE ESTANQUIDADE PARA UNIÃO PLANA



- * Aplicação: gases, água, óleos e hidrocarbonetos
- * Ótima qualidade em relação pressão - temp. P (0-50 bar) / Tª (0° C a 220° C)
- * Certificadas para água potável (TZW) e gás (DVGW - VP 401 e DVGW DIN 3535-6)

Ø	Ø Int. mm.	Ø Ext. mm.	ESPESSURA	COD.	€
1/2"	24	34	2	90000003	0,24
3/4"	27	38	2	90000004	0,31
1"	32	44	2	90000005	0,39
1 1/4"	42	55	2	90000006	0,59
1 1/2"	46	62	2	90000007	0,68
2"	60	78	2	90000008	0,94
2 1/2"	75	96	3	90000009	2,75
3"	88	109	3	9000000A	3,53
4"	113	134	3	9000000C	4,93



334 UNIÃO DE COMPENSAÇÃO

Ø	Imagem	NEGRO		GALVANIZADO	
		COD.	€	COD.	€
1/2" x 88	50 1			33405003	9,15
3/4" x 96	30 1			33405004	10,30
1" x 106	20 1			33405005	11,60
1 1/4" x 118	15 1			33405006	16,95
1 1/2" x 122	10 1			33405007	20,85
2" x 134	8 1			33405008	29,80



471 JOELHO FÊMEA C/PATER

Ø	Imagem	NEGRO		GALVANIZADO	
		COD.	€	COD.	€
1/2"	40 10			47105003	11,65
3/4"	30 10			47105004	22,48
1"	20 10			47105005	33,71



529 UNIÃO M/F SIMPLES

ISO/EN M4

Ø	Imagem	NEGRO		GALVANIZADO	
		COD.	€	COD.	€
3/8"	300 10	52901002	2,01	52905002	2,47
1/2"	200 10	52901003	1,78	52905003	2,28
3/4"	120 10	52901004	2,37	52905004	3,02
1"	60 10	52901005	3,59	52905005	4,75
1 1/4"	40 1	52901006	6,54	52905006	7,87
1 1/2"	35 1	52901007	9,44	52905007	11,43
2"	20 1	52901008	15,69	52905008	19,09

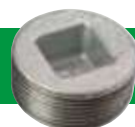

596 TAMPÃO MACHO DE QUADRA INTERIOR

ISO/EN T11

Ø	Imagem	NEGRO		GALVANIZADO	
		COD.	€	COD.	€
1/2"	200 10			59605003	2,60
3/4"	150 10	59601004	2,60		
1"	150 10	59601005	3,12		
1 1/4"	140 1	59601006	4,73		
1 1/2"	125 1	59601007	9,05	59605007	11,03
2"	60 1	59601008	12,80		

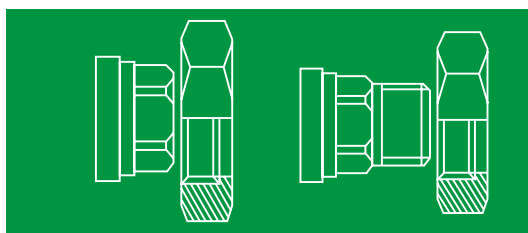

JOGOS DE LIGAÇÃO PARA BOMBAS

- **1 Jogo compõe-se por:**
 - 2 Porcas Ref. 374 (P1).
Rosca de sujeição EN - ISO 228-1.
 - 2 Peças loucas Ref. 372 ou 371.
Roscas de união DIN 2999 / ISO 7-1 / EN 10226-1.
 - 2 Juntas de fibra sem amianto:
 - Temperatura máx. 300° C.
 - Temperatura máx. com vapor 200° C.
 - Certificados DVGW para gases industriais.
 - Certificados KTW para alimentação e água potável.
- Os jogos são fabricados em acabamento negro sem galvanizar, caso não se especifique o contrário.
- Cada jogo é fornecido em bolsa de plástico e caixa de cartão, devidamente etiquetadas.

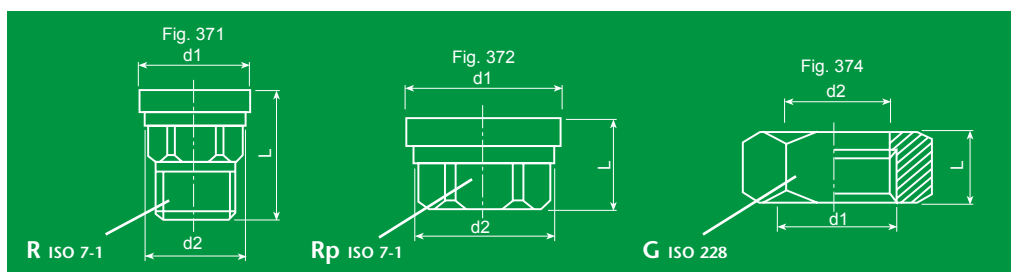

3/4" (372 Reduz.)
JOGO
C4201047

FIG	€	mm.			Box	(grs.)
		d1	d2	L		
372 Rp 3/4"	12,98	44,2	40,9	26,0	20	464
374 G 1 1/2"		45,15	41,8	22,0		

1"
JOGO
C4201057

FIG	€	mm.			Box	(grs.)
		d1	d2	L		
372 Rp 1"	10,42	44,2	40,9	26,5	20	474
374 G 1 1/2"		45,15	41,8	22,0		

1" (372 Reduz.)
JOGO
C4201058

FIG	€	mm.			Box	(grs.)
		d1	d2	L		
372 Rp 1"	18,63	56,0	52,2	31,0	15	854
374 G 2"		56,9	52,9	24,0		

1" M
JOGO
C4101057

FIG	€	mm.			Box	(grs.)
		d1	d2	L		
371 R 1"	19,83	44,2	40,9	49,0	18	620
374 G 1 1/2"		45,15	41,8	22,0		

1 1/4" (371 Ampl.)
JOGO
C4101067

FIG	€	mm.			Box	(grs.)
		d1	d2	L		
371 R 1 1/4"	21,95	44,2	40,9	48,0	15	624
374 G 1 1/2"		45,15	41,8	22,0		

1 1/4"
JOGO
C4201068

FIG	€	mm.			Box	(grs.)
		d1	d2	L		
372 Rp 1 1/4"	15,79	56,0	52,2	31,0	15	878
374 G 2"		56,9	52,9	24,0		

JUNTAS RÁPIDAS

As juntas Rápidas EO partilham com os acessórios de ferro fundido maleável EO as características e o processo de fabrico. Desenhadas para a união de tubagem pelo método de ajuste e compressão, este sistema simplifica e otimiza tanto a montagem de novas, bem como a manutenção e alterações de instalações já existentes. Os parâmetros de desenho deste produto permitem ótimas condições de serviço, garantindo a estanquidade das instalações na utilização de líquidos ou gases.

As juntas rápidas EO estão disponíveis em 3 modelos – junta rápida, tomada de derivação e tapaporos – esta gama de produto EO rapidamente se transformou numa referência de mercado devido às suas excelentes prestações e campo de aplicação alargado dos quais se destacam: Água, gás, combustível, ar comprimido, óleos.





ATUSA

JUNTAS
RÁPIDAS

JUNTAS
RÁPIDAS



740
3/8" a 2 1/2"



740
3" e 4"



746
3/8" a 2 1/2"



746
3" e 4"



770
1/2" a 2 1/2"



770
3" e 4"



790
1/2" a 2"



790
2 1/2" e 3"



730
1/2" a 2"



730
2 1/2" e 3"



730R
varias



730R
varias



710
1/2" a 4"



715
1/2" a 2"



720
varias

740 JUNTA FÊMEA



Ø			COD.	€
3/8"	75	5	740A5002	9,03
1/2"	60	5	740A5003	9,03
3/4"	30	5	740A5004	10,25
1"	20	4	740A5005	11,52
1 1/4"	16	4	740A5006	16,91
1 1/2"	12	3	740A5007	20,82
2"	6	2	740A5008	29,70
2 1/2"	6	2	740A5009	53,85
* 3"	2	1	740A500A	87,29
* 4"	1		740A500C	200,30

746 JUNTA MACHO



Ø			COD.	€
3/8"	75	5	746A5002	8,97
1/2"	55	5	746A5003	8,97
3/4"	30	5	746A5004	10,05
1"	20	4	746A5005	11,42
1 1/4"	16	4	746A5006	16,46
1 1/2"	12	3	746A5007	20,37
2"	6	2	746A5008	28,93
2 1/2"	6	2	746A5009	52,77
* 3"	2	1	746A500A	83,34
* 4"	1		746A500C	187,92

770 JUNTA DUPLA



Ø			COD.	€
1/2"	50	5	770A5003	12,79
3/4"	25	5	770A5004	14,97
1"	16	4	770A5005	17,72
1 1/4"	12	3	770A5006	23,07
1 1/2"	9	3	770A5007	30,39
2"	6	2	770A5008	43,59
2 1/2"	4	2	770A5009	82,42
* 3"	2	1	770A500A	118,60
* 4"	1		770A500C	293,01

Galvanizado

* Flangeada

790 JUNTA JOELHO



Ø			COD.	€
1/2"	40	1	790A5003	27,90
3/4"	20	1	790A5004	37,48
1"	15	1	790A5005	42,63
1 1/4"	10	1	790A5006	59,05
1 1/2"	6	1	790A5007	80,80
2"	4	1	790A5008	88,76
* 2 1/2"	2	1	790A5009	225,08
* 3"	2	1	790A500A	273,82

730 JUNTA TÊ



Ø			COD.	€
1/2"	30	1	730A5003	32,37
3/4"	20	1	730A5004	40,20
1"	15	1	730A5005	47,18
1 1/4"	10	1	730A5006	63,80
1 1/2"	6	1	730A5007	81,08
2"	4	1	730A5008	102,09
* 2 1/2"	2	1	730A5009	233,98
* 3"	2	1	730A500A	252,86

730R JUNTA TÊ DE REDUÇÃO

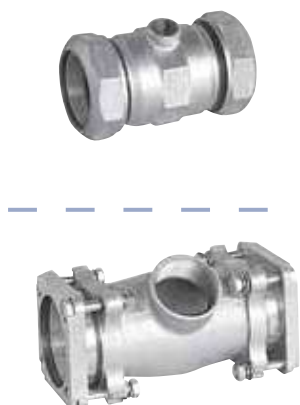

Ø			COD.	€
3/4" x 1/2"	20	1	730A5434	26,23
1" x 1/2"	15	1	730A5535	29,41
1" x 3/4"	15	1	730A5545	31,22
1 1/4" x 1/2"	10	1	730A5636	37,89
1 1/4" x 3/4"	10	1	730A5646	37,69
1 1/4" x 1"	10	1	730A5656	40,18
1 1/2" x 1/2"	6	1	730A5737	54,97
1 1/2" x 3/4"	6	1	730A5747	57,80
1 1/2" x 1"	6	1	730A5757	56,24
1 1/2" x 1 1/4"	6	1	730A5767	49,76
2" x 1/2"	4	1	730A5838	70,62
2" x 3/4"	4	1	730A5848	69,74
2" x 1"	4	1	730A5858	70,86
2" x 1 1/4"	4	1	730A5868	74,32
2" x 1 1/2"	4	1	730A5878	63,50
* 2 1/2" x 2"	2	1	730A5989	117,42
* 3" x 2"	2	1	730A5A8A	183,63

Galvanizado

* Flangeada

710 TAPAPOROS LARGO



Ø		COD.	€
1/2"	17 1	71005003	12,40
3/4"	13 1	71005004	13,46
1"	11 1	71005005	15,81
1 1/4"	9 1	71005006	19,92
1 1/2"	7 1	71005007	21,97
2"	5 1	71005008	26,63
2 1/2"	4 1	71005009	34,20
3"	2 1	7100500A	42,42
4"	1	7100500C	57,97

715 TAPAPOROS CURTO



Ø		COD.	€
1/2"	40 1	71505003	6,20
3/4"	30 1	71505004	6,93
1"	20 1	71505005	8,84
1 1/4"	16 1	71505006	11,81
1 1/2"	11 1	71505007	13,34
2"	8 1	71505008	16,92

720 TOMADA DE DERIVAÇÃO



Ø		COD.	€
1/2" x 1/2"	35 1	72005033	7,37
3/4" x 1/2"	30 1	72005043	8,50
1" x 1/2"	23 1	72005053	10,71
1 1/4" x 3/4"	14 1	72005064	12,34
1 1/2" x 3/4"	10 1	72005074	14,31
2" x 1"	8 1	72005085	18,14

 Galvanizado

SISTEMA **RANHURADO**

Fabricados em ferro dúctil conforme ASTM A-536 grau 65-45-12 com junta de estanquidade (EPDM grau E conforme ASTM D-2000) bem como os correspondentes elementos de aperto (parafusos e porcas de aço electro zincado). Estão disponíveis em galvanizado a quente ou pintados em vermelho.

Aptos para o transporte de fluidos tais como água, ar isento de óleos e uma ampla gama de produtos químicos, estão certificados para instalações de redes contra incêndios conforme as normas FM Approvals 1920, UL 213 e Vds 2100-06 / 2344.

As válvulas estão certificadas para Instalações Contra Incêndios de acordo com os requisitos da FM, UL e VdS.



FM (Factory Mutual Research Corp.)



VdS (Vertrauen durch Sicherheit)



UL (Underwriter's Laboratories, Inc.)



WRAS (Water Regulations Advisory Scheme Ltd.)

EPDM Rubber Approval



◀ **ATUSA**

SISTEMA
RANHURADO

SISTEMA
RANHURADO

RN UNIÃO RÍGIDA NORMAL

Ø	Ø EXT. mm.	DN		COD. VERMELHO (RAL 3000)	€	COD. GALVANIZADO	€
1"	33,7	25	32	6RN2G205	6,60	6RN2G505	7,75
1 1/4"	42,4	32	27	6RN2G206	6,75	6RN2G506	8,10
1 1/2"	48,3	40	24	6RN2G207	7,00	6RN2G507	8,40
2"	60,3	50	16	6RN2G208	7,40	6RN2G508	8,95
2 1/2"	76,1	65	12	6RN2G20B	7,55	6RN2G50B	9,25
3"	88,9	80	20	6RN2G20A	11,95	6RN2G50A	14,40
4"	114,3	100	10	6RN2G20C	18,40	6RN2G50C	21,90
5"	139,7	125	8	6RN2G20H	20,75	6RN2G50H	24,45
6 1/2" O.D	165,1	150	5	6RN2G20K	26,15	6RN2G50K	31,75
6"	168,3	150	5	6RN2G20E	26,00	6RN2G50E	31,45
8"	219,1	200	3	6RN2G20M	47,20	6RN2G50M	57,35
10"	273,0	250	3	6RN2G20N	97,30	6RN2G50N	117,70
12"	323,9	300	3	6RN2G20Q	98,15	6RN2G50Q	120,80

RS UNIÃO RÍGIDA "S" STANDARD



Ø	Ø EXT. mm.	DN		COD. VERMELHO (RAL 3000)	€	COD. GALVANIZADO	€
2 1/2"	76,1	65	12	6RN2G20B	7,55	6RN2G50B	9,25
3"	88,9	80	20	6RS2G20A	9,35	6RS2G50A	11,40
4"	114,3	100	11	6RS2G20C	14,15	6RS2G50C	17,15
5"	139,7	125	8	6RS2G20H	16,00	6RS2G50H	19,65
6 1/2" O.D	165,1	150	7	6RS2G20K	20,00	6RS2G50K	24,20
6"	168,3	150	7	6RS2G20E	19,85	6RS2G50E	23,85
8"	219,1	200	3	6RS2G20M	37,65	6RS2G50M	45,35
10"	273,0	250	3	6RS2G20N	92,00	6RS2G50N	110,30

FN UNIÃO FLEXÍVEL NORMAL

Ø	Ø EXT. mm.	DN		COD. VERMELHO (RAL 3000)	€	COD. GALVANIZADO	€
1"	33,7	25	32	6FN2G205	6,05	6FN2G505	6,95
1 1/4"	42,4	32	27	6FN2G206	6,25	6FN2G506	7,20
1 1/2"	48,3	40	24	6FN2G207	6,65	6FN2G507	7,50
2"	60,3	50	16	6FN2G208	6,80	6FN2G508	7,90
2 1/2"	76,1	65	12	6FN2G20B	8,80	6FN2G50B	10,10
3"	88,9	80	20	6FN2G20A	10,75	6FN2G50A	12,35
4"	114,3	100	10	6FN2G20C	16,60	6FN2G50C	19,40
5"	139,7	125	8	6FN2G20H	21,20	6FN2G50H	25,30
6 1/2" O.D	165,1	150	5	6FN2G20K	25,70	6FN2G50K	30,15
6"	168,3	150	5	6FN2G20E	25,55	6FN2G50E	29,95
8"	219,1	200	3	6FN2G20M	45,35	6FN2G50M	51,40
10"	273,0	250	3	6FN2G20N	87,55	6FN2G50N	99,20
12"	323,9	300	3	6FN2G20Q	95,15	6FN2G50Q	109,50

FR UNIÃO DE REDUÇÃO



Ø	Ø EXT. mm.	DN		COD. VERMELHO (RAL 3000)	€	COD. GALVANIZADO	€
2"x1 1/2"	60,3x48,3	50x40	16	6FR2G287	26,15	6FR2G587	31,40
2 1/2"x2"	76,1x60,3	65x50	12	6FR2G2B8	31,40	6FR2G5B8	37,50
3"x2"	88,9x60,3	80x50	16	6FR2G2A8	34,85	6FR2G5A8	41,75
3"x2 1/2"	88,9x76,1	80x65	16	6FR2G2AB	34,85	6FR2G5AB	41,75
4"x2"	114,3x60,3	100x50	8	6FR2G2C8	46,25	6FR2G5C8	55,90
4"x2 1/2"	114,3x76,1	100x65	8	6FR2G2CB	46,25	6FR2G5CB	55,90
4"x3"	114,3x88,9	100x80	8	6FR2G2CA	46,25	6FR2G5CA	55,90

DS1 DERIVAÇÃO SIMPLES ROSCADA



Ø	Ø EXT. mm.	DN		COD. VERMELHO (RAL 3000)	€	COD. GALVANIZADO	€
1 1/4"x1"	42,4x33,7	32x25	30	6DS2T265	8,40	6DS2T565	10,10
1 1/2"x1"	48,3x33,7	40x25	30	6DS2T275	9,25	6DS2T575	11,15
2"x1/2"	60,3x21,3	50x15	18	6DS2T283	13,65	6DS2T583	16,40
2"x3/4"	60,3x26,9	50x20	18	6DS2T284	13,65	6DS2T584	16,40
2"x1"	60,3x33,7	50x25	18	6DS2T285	13,65	6DS2T585	16,40
2"x1 1/4"	60,3x42,4	50x32	12	6DS2T286	13,65	6DS2T586	16,40
2"x1 1/2"	60,3x48,3	50x40	15	6DS2T287	13,65	6DS2T587	16,40
2 1/2"x1/2"	76,1x21,3	65x15	10	6DS2T2B3	17,70	6DS2T5B3	20,70
2 1/2"x3/4"	76,1x26,9	65x20	10	6DS2T2B4	17,70	6DS2T5B4	20,70
2 1/2"x1"	76,1x33,7	65x25	10	6DS2T2B5	17,70	6DS2T5B5	20,70
2 1/2"x1 1/4"	76,1x42,4	65x32	8	6DS2T2B6	17,70	6DS2T5B6	20,70
2 1/2"x1 1/2"	76,1x48,3	65x40	8	6DS2T2B7	17,70	6DS2T5B7	20,70
3"x1/2"	88,9x21,3	80x15	6	6DS2T2A3	18,25	6DS2T5A3	21,45
3"x3/4"	88,9x26,9	80x20	6	6DS2T2A4	18,25	6DS2T5A4	21,45
3"x1"	88,9x33,7	80x25	6	6DS2T2A5	18,25	6DS2T5A5	21,45
3"x1 1/4"	88,9x42,4	80x32	8	6DS2T2A6	18,25	6DS2T5A6	21,45
3"x1 1/2"	88,9x48,3	80x40	8	6DS2T2A7	18,25	6DS2T5A7	21,45
3"x2"	88,9x60,3	80x50	5	6DS2T2A8	18,25	6DS2T5A8	21,45
4"x1/2"	114,3x21,3	100x15	12	6DS2T2C3	23,25	6DS2T5C3	26,75
4"x3/4"	114,3x26,9	100x20	12	6DS2T2C4	23,25	6DS2T5C4	26,75
4"x1"	114,3x33,7	100x25	12	6DS2T2C5	23,25	6DS2T5C5	26,75
4"x1 1/4"	114,3x42,4	100x32	10	6DS2T2C6	23,65	6DS2T5C6	27,10
4"x1 1/2"	114,3x48,3	100x40	10	6DS2T2C7	23,65	6DS2T5C7	27,10
4"x2"	114,3x60,3	100x50	10	6DS2T2C8	23,65	6DS2T5C8	27,10
4"x2 1/2"	114,3x76,1	100x65	8	6DS2T2CB	23,65	6DS2T5CB	27,10
4"x3"	114,3x88,9	100x80	6	6DS2T2CA	23,65	6DS2T5CA	27,10
5"x1"	139,7x33,7	125x25	6	6DS2T2H5	28,50	6DS2T5H5	33,85
5"x2"	139,7x60,3	125x50	4	6DS2T2H8	28,50	6DS2T5H8	33,85
6 1/2" O.Dx1 1/2"	165,1x48,3	150x40	5	6DS2T2K7	33,65	6DS2T5K7	39,55
6 1/2" O.Dx2"	165,1x60,3	150x50	5	6DS2T2K8	33,65	6DS2T5K8	39,55
6 1/2" O.Dx2 1/2"	165,1x76,1	150x65	5	6DS2T2KB	33,65	6DS2T5KB	39,55
6"x1 1/4"	168,3x42,4	150x32	5	6DS2T2E6	34,40	6DS2T5E6	39,40
6"x1 1/2"	168,3x48,3	150x40	5	6DS2T2E7	34,40	6DS2T5E7	39,40
6"x2"	168,3x60,3	150x50	5	6DS2T2E8	34,40	6DS2T5E8	39,40
6"x3"	168,3x88,9	150x80	4	6DS2T2EA	34,40	6DS2T5EA	39,40
8"x2"	219,1x60,3	200x50	3	6DS2T2M8	55,65	6DS2T5M8	65,95
10"x2"	273,0x60,3	250x50	4	6DS2T2N8	72,75	6DS2T5N8	83,30
10"x2 1/2"	273,0x76,1	250x65	4	6DS2T2NB	72,75	6DS2T5NB	83,30
10"x3"	273,0x88,9	250x80	3	6DS2T2NA	72,75	6DS2T5NA	83,30

DS2 DERIVAÇÃO SIMPLES RANHURADA



Ø	Ø EXT. mm.	DN		COD. VERMELHO (RAL 3000)	€	COD. GALVANIZADO	€
2"x1 1/4"	60,3x42,4	50x32	15	6DS2G286	14,45	6DS2G586	17,30
2"x1 1/2"	60,3x48,3	50x40	15	6DS2G287	14,45	6DS2G587	17,30
2 1/2"x1"	76,1x33,7	65x25	8	6DS2G2B5	18,65	6DS2G5B5	21,80
2 1/2"x1 1/4"	76,1x42,4	65x32	8	6DS2G2B6	18,65	6DS2G5B6	21,80
2 1/2"x1 1/2"	76,1x48,3	65x40	8	6DS2G2B7	18,65	6DS2G5B7	21,80
3"x1"	88,9x33,7	80x25	8	6DS2G2A5	21,70	6DS2G5A5	26,45
3"x1 1/4"	88,9x42,4	80x32	8	6DS2G2A6	21,70	6DS2G5A6	26,45
3"x1 1/2"	88,9x48,3	80x40	8	6DS2G2A7	21,70	6DS2G5A7	26,45
3"x2"	88,9x60,3	80x50	5	6DS2G2A8	21,70	6DS2G5A8	26,45
4"x1 1/4"	114,3x42,4	100x32	12	6DS2G2C6	24,00	6DS2G5C6	28,60
4"x1 1/2"	114,3x48,3	100x40	10	6DS2G2C7	24,00	6DS2G5C7	28,60
4"x2"	114,3x60,3	100x50	10	6DS2G2C8	24,00	6DS2G5C8	28,60
4"x2 1/2"	114,3x76,1	100x65	8	6DS2G2CB	24,00	6DS2G5CB	28,60
4"x3"	114,3x88,9	100x80	8	6DS2G2CA	24,00	6DS2G5CA	28,60
5"x1 1/4"	139,7x42,4	125x32	6	6DS2G2H6	30,00	6DS2G5H6	36,05
5"x2"	139,7x60,3	125x50	4	6DS2G2H8	30,00	6DS2G5H8	36,05
5"x2 1/2"	139,7x76,1	125x65	4	6DS2G2HB	30,00	6DS2G5HB	36,05
5"x3"	139,7x88,9	125x80	4	6DS2G2HA	30,00	6DS2G5HA	36,05
6 1/2" O.Dx2"	165,1x60,3	150x50	5	6DS2G2K8	40,60	6DS2G5K8	48,05
6 1/2" O.Dx2 1/2"	165,1x76,1	150x65	5	6DS2G2KB	40,60	6DS2G5KB	48,05
6"x1 1/4"	168,3x42,4	150x32	5	6DS2G2E6	39,00	6DS2G5E6	46,85
6"x1 1/2"	168,3x48,3	150x40	5	6DS2G2E7	39,00	6DS2G5E7	46,85
6"x2"	168,3x60,3	150x50	5	6DS2G2E8	39,00	6DS2G5E8	46,85
6"x2 1/2"	168,3x76,1	150x65	4	6DS2G2EB	39,00	6DS2G5EB	46,85
6"x3"	168,3x88,9	150x80	4	6DS2G2EA	39,00	6DS2G5EA	46,85
6"x4"	168,3x114,3	150x100	4	6DS2G2EC	39,00	6DS2G5EC	46,85
8"x2"	219,1x60,3	200x50	3	6DS2G2M8	64,50	6DS2G5M8	78,95
8"x2 1/2"	219,1x76,1	200x65	3	6DS2G2MB	64,50	6DS2G5MB	78,95
8"x3"	219,1x88,9	200x80	3	6DS2G2MA	64,50	6DS2G5MA	78,95
8"x4"	219,1x114,3	200x100	3	6DS2G2MC	64,50	6DS2G5MC	78,95
10"x4"	273,0x114,3	250x100	3	6DS2G2NC	99,20	6DS2G5NC	120,90

DA1 DERIVAÇÃO PARA SPRINKLER



Ø	Ø EXT. mm.	DN		COD. VERMELHO (RAL 3000)	€	COD. GALVANIZADO	€
1 1/4"x1/2"	42,4x21,3	32x15	32	6DA2T263	7,15	6DA2T563	8,45
1 1/4"x3/4"	42,4x26,9	32x20	32	6DA2T264	7,15	6DA2T564	8,45
1 1/4"x1"	42,4x33,7	32x25	32	6DA2T265	7,15	6DA2T565	8,45
1 1/2"x1/2"	48,3x21,3	40x15	32	6DA2T273	7,60	6DA2T573	8,80
1 1/2"x3/4"	48,3x26,9	40x20	32	6DA2T274	7,60	6DA2T574	8,80
1 1/2"x1"	48,3x33,7	40x25	24	6DA2T275	7,60	6DA2T575	8,80
2"x1/2"	60,3x21,3	50x15	30	6DA2T283	7,75	6DA2T583	8,90
2"x3/4"	60,3x26,9	50x20	30	6DA2T284	7,75	6DA2T584	8,90
2"x1"	60,3x33,7	50x25	20	6DA2T285	7,75	6DA2T585	8,90
2 1/2"x1/2"	76,1x21,3	65x15	20	6DA2T2B3	10,25	6DA2T5B3	12,10
2 1/2"x3/4"	76,1x26,9	65x20	20	6DA2T2B4	10,25	6DA2T5B4	12,10
2 1/2"x1"	76,1x33,7	65x25	20	6DA2T2B5	10,25	6DA2T5B5	12,10

90 JOELHO 90°



Ø	Ø EXT. mm.	DN		COD. VERMELHO (RAL 3000)	€	COD. GALVANIZADO	€
1"	33,7	25	40	60900205	3,60	60900505	4,45
1 1/4"	42,4	32	32	60900206	4,50	60900506	5,30
1 1/2"	48,3	40	24	60900207	5,20	60900507	6,25
2"	60,3	50	14	60900208	8,55	60900508	10,10
2 1/2"	76,1	65	6	6090020B	11,15	6090050B	13,05
3"	88,9	80	4	6090020A	13,15	6090050A	15,65
4"	114,3	100	4	6090020C	20,35	6090050C	24,10
5"	139,7	125	2	6090020H	30,25	6090050H	36,10
6 1/2" O.D	165,1	150	1	6090020K	42,80	6090050K	50,55
6"	168,3	150	1	6090020E	42,50	6090050E	50,30
8"	219,1	200	1	6090020M	86,65	6090050M	102,60
10"	273,0	250	1	6090020N	151,70	6090050N	179,15
12"	323,9	300	1	6090020Q	209,35	6090050Q	248,40

90S JOELHO 90° "S" STANDARD



Ø	Ø EXT. mm.	DN		COD. VERMELHO (RAL 3000)	€	COD. GALVANIZADO	€
2"	60,3	50	30	6090S208	6,65	6090S508	7,70
2 1/2"	76,1	65	14	6090S20B	8,55	6090S50B	10,10
3"	88,9	80	10	6090S20A	10,60	6090S50A	12,15
4"	114,3	100	10	6090S20C	16,40	6090S50C	19,05
5"	139,7	125	6	6090S20H	24,20	6090S50H	28,35
6 1/2" O.D	165,1	150	4	6090S20K	33,25	6090S50K	39,15
6"	168,3	150	4	6090S20E	32,90	6090S50E	39,05
8"	219,1	200	1	6090S20M	67,85	6090S50M	78,05

105 JOELHO 11,25°



Ø	Ø EXT. mm.	DN		COD. VERMELHO (RAL 3000)	€	COD. GALVANIZADO	€
1 1/4"	42,4	32	48	61050206	4,95	61050506	5,75
1 1/2"	48,3	40	40	61050207	5,75	61050507	6,55
2"	60,3	50	27	61050208	8,15	61050508	9,50
2 1/2"	76,1	65	12	6105020B	11,20	6105050B	13,05
3"	88,9	80	12	6105020A	15,95	6105050A	18,70
4"	114,3	100	12	6105020C	27,75	6105050C	32,30
5"	139,7	125	5	6105020H	40,65	6105050H	47,25
6 1/2" O.D	165,1	150	4	6105020K	55,50	6105050K	64,35
6"	168,3	150	4	6105020E	55,50	6105050E	64,35
8"	219,1	200	1	6105020M	110,75	6105050M	128,65

110 JOELHO 22,5°



Ø	Ø EXT. mm.	DN		COD. VERMELHO (RAL 3000)	€	COD. GALVANIZADO	€
1 1/4"	42,4	32	40	61100206	4,95	61100506	5,75
1 1/2"	48,3	40	40	61100207	5,75	61100507	6,55
2"	60,3	50	18	61100208	8,15	61100508	9,50
2 1/2"	76,1	65	10	6110020B	11,20	6110050B	13,05
3"	88,9	80	8	6110020A	15,95	6110050A	18,70
4"	114,3	100	6	6110020C	27,75	6110050C	32,30
5"	139,7	125	3	6110020H	40,65	6110050H	47,25
6 1/2" O.D	165,1	150	2	6110020K	55,50	6110050K	64,35
6"	168,3	150	2	6110020E	55,50	6110050E	64,35
8"	219,1	200	1	6110020M	110,75	6110050M	128,65

120 JOELHO 45°



Ø	Ø EXT. mm.	DN		COD. VERMELHO (RAL 3000)	€	COD. GALVANIZADO	€
1"	33,7	25	40	61200205	3,90	61200505	4,75
1 1/4"	42,4	32	36	61200206	4,35	61200506	5,05
1 1/2"	48,3	40	36	61200207	4,85	61200507	5,80
2"	60,3	50	18	61200208	6,25	61200508	7,15
2 1/2"	76,1	65	10	6120020B	8,30	6120050B	9,65
3"	88,9	80	6	6120020A	9,95	6120050A	11,75
4"	114,3	100	6	6120020C	15,20	6120050C	17,85
5"	139,7	125	3	6120020H	25,05	6120050H	28,85
6 1/2" O.D	165,1	150	2	6120020K	31,00	6120050K	36,10
6"	168,3	150	2	6120020E	30,90	6120050E	35,75
8"	219,1	200	1	6120020M	67,85	6120050M	78,05
10"	273,0	250	1	6120020N	140,20	6120050N	162,15
12"	323,9	300	1	6120020Q	236,95	6120050Q	279,45

240 REDUÇÃO CONCÊNTRICA



Ø	Ø EXT. mm.	DN		COD. VERMELHO (RAL 3000)	€	COD. GALVANIZADO	€
1 1/4"x1"	42,4x33,7	32x25	60	62400265	6,90	62400565	9,45
1 1/2"x1"	48,3x33,7	40x25	50	62400275	7,70	62400575	10,05
1 1/2"x1 1/4"	48,3x42,4	40x32	50	62400276	7,70	62400576	10,05
2"x1"	60,3x33,7	50x25	36	62400285	8,55	62400585	10,85
2"x1 1/4"	60,3x42,4	50x32	36	62400286	8,55	62400586	10,85
2"x1 1/2"	60,3x48,3	50x40	36	62400287	8,55	62400587	10,85
2 1/2"x1"	76,1x33,7	65x25	18	62400285	11,25	62400585	14,30
2 1/2"x1 1/4"	76,1x42,4	65x32	18	62400286	11,25	62400586	14,30
2 1/2"x1 1/2"	76,1x48,3	65x40	18	62400287	11,25	62400587	14,30
2 1/2"x2"	76,1x60,3	65x50	18	62400288	11,25	62400588	14,30
3"x1"	88,9x33,7	80x25	21	624002A5	12,60	624005A5	15,40
3"x1 1/4"	88,9x42,4	80x32	21	624002A6	12,60	624005A6	15,40
3"x1 1/2"	88,9x48,3	80x40	21	624002A7	12,60	624005A7	15,40
3"x2"	88,9x60,3	80x50	21	624002A8	12,60	624005A8	15,40
3"x 2 1/2"	88,9x76,1	80x65	18	624002AB	12,60	624005AB	15,40
4"x1 1/4"	114,3x42,4	100x32	24	624002C6	15,80	624005C6	19,20
4"x1 1/2"	114,3x48,3	100x40	24	624002C7	15,80	624005C7	19,20
4"x2"	114,3x60,3	100x50	24	624002C8	15,80	624005C8	19,20
4"x 2 1/2"	114,3x76,1	100x65	24	624002CB	15,80	624005CB	19,20
4"x3"	114,3x88,9	100x80	18	624002CA	15,80	624005CA	19,20
5"x4"	139,7x114,3	125x100	4	624002HC	23,85	624005HC	28,45
6 1/2" O.Dx2 1/2"	165,1x76,1	150x65	7	624002KB	30,55	624005KB	36,40
6 1/2" O.Dx3"	165,1x88,9	150x80	7	624002KA	30,55	624005KA	36,40
6 1/2" O.Dx4"	165,1x114,3	150x100	7	624002KC	30,55	624005KC	36,40
6 1/2" O.Dx5"	165,1x139,7	150x125	4	624002KH	30,55	624005KH	36,40
6"x2"	168,3x60,3	150x50	7	624002E8	30,55	624005E8	36,40
6"x2 1/2"	168,3x76,1	150x65	7	624002EB	30,55	624005EB	36,40
6"x3"	168,3x88,9	150x80	7	624002EA	30,55	624005EA	36,40
6"x4"	168,3x114,3	150x100	7	624002EC	30,55	624005EC	36,40
6"x5"	168,3x139,7	150x125	4	624002EH	30,55	624005EH	36,40
8"x3"	219,1x88,9	200x80	4	624002MA	46,10	624005MA	55,15
8"x4"	219,1x114,3	200x100	4	624002MC	46,10	624005MC	55,15
8"x5"	219,1x139,7	200x125	3	624002MH	46,10	624005MH	55,15
8"x6 1/2" O.D	219,1x165,1	200x150	3	624002MK	46,10	624005MK	55,15
8"x6"	219,1x168,3	200x150	4	624002ME	46,10	624005ME	55,15
10"x6"	273,0x168,3	250x150	1	624002NE	88,25	624005NE	106,45
10"x8"	273,0x219,1	250x200	1	624002NM	88,25	624005NM	106,45
12"x8"	323,9x219,1	300x200	1	624002QM	183,65	624005QM	264,25
12"x10"	323,9x273,0	300x250	1	624002QN	189,70	624005QN	271,05

130 TÊ



Ø	Ø EXT. mm.	DN		COD. VERMELHO (RAL 3000)	€	COD. GALVANIZADO	€
1"	33,7	25	42	61300205	5,40	61300505	6,50
1 1/4"	42,4	32	22	61300206	6,35	61300506	7,35
1 1/2"	48,3	40	18	61300207	8,00	61300507	9,55
2"	60,3	50	8	61300208	12,40	61300508	14,90
2 1/2"	76,1	65	7	6130020B	16,50	6130050B	19,45
3"	88,9	80	5	6130020A	20,00	6130050A	23,85
4"	114,3	100	3	6130020C	30,90	6130050C	37,05
5"	139,7	125	1	6130020H	49,90	6130050H	59,95
6 1/2" O.D	165,1	150	1	6130020K	71,80	6130050K	86,00
6"	168,3	150	2	6130020E	71,45	6130050E	85,75
8"	219,1	200	1	6130020M	129,80	6130050M	153,10
10"	273,0	250	1	6130020N	252,85	6130050N	303,30
12"	323,9	300	1	6130020Q	346,75	6130050Q	411,70

130S TÊ "S" STANDARD



Ø	Ø EXT. mm.	DN		COD. VERMELHO (RAL 3000)	€	COD. GALVANIZADO	€
2"	60,3	50	18	6130S208	9,65	6130S508	11,45
2 1/2"	76,1	65	10	6130S20B	12,90	6130S50B	15,20
3"	88,9	80	6	6130S20A	15,85	6130S50A	18,80
4"	114,3	100	6	6130S20C	24,45	6130S50C	28,85
5"	139,7	125	4	6130S20H	39,70	6130S50H	47,60
6 1/2" O.D	165,1	150	2	6130S20K	56,30	6130S50K	66,75
6"	168,3	150	2	6130S20E	56,05	6130S50E	66,45
8"	219,1	200	1	6130S20M	101,15	6130S50M	119,30

130R TÊ DE REDUÇÃO



Ø	Ø EXT. mm.	DN		COD. VERMELHO (RAL 3000)	€	COD. GALVANIZADO	€
2"x1"	60,3x33,7	50x25	8	61300285	17,90	61300585	21,10
2"x1 1/2"	60,3x48,3	50x40	8	61300287	17,90	61300587	21,10
2 1/2"x1 1/4"	76,1x42,4	65x32	7	613002B6	22,55	613005B6	26,75
2 1/2"x1 1/2"	76,1x48,3	65x40	7	613002B7	22,55	613005B7	26,75
2 1/2"x2"	76,1x60,3	65x50	7	613002B8	22,55	613005B8	26,75
3"x1"	88,9x33,7	80x25	5	613002A5	27,20	613005A5	32,85
3"x1 1/4"	88,9x42,4	80x32	5	613002A6	27,20	613005A6	32,85
3"x1 1/2"	88,9x48,3	80x40	5	613002A7	27,20	613005A7	32,85
3"x2"	88,9x60,3	80x50	5	613002A8	27,20	613005A8	32,85
3"x2 1/2"	88,9x76,1	80x65	5	613002AB	27,20	613005AB	32,85
4"x1 1/2"	114,3x48,3	100x40	3	613002C7	46,30	613005C7	55,20
4"x2"	114,3x60,3	100x50	3	613002C8	46,30	613005C8	55,20
4"x2 1/2"	114,3x76,1	100x65	3	613002CB	46,30	613005CB	55,20
4"x3"	114,3x88,9	100x80	2	613002CA	46,30	613005CA	55,20
5"x4"	139,7x114,3	125x100	1	613002HC	61,75	613005HC	73,60
6 1/2" O.Dx2"	165,1x60,3	150x50	1	613002K8	90,40	613005K8	107,65
6 1/2" O.Dx2 1/2"	165,1x76,1	150x65	1	613002KB	90,40	613005KB	107,65
6 1/2" O.Dx3"	165,1x88,9	150x80	1	613002KA	90,40	613005KA	107,65
6 1/2" O.Dx4"	165,1x114,3	150x100	1	613002KC	90,40	613005KC	107,65
6 1/2" O.Dx5"	165,1x139,7	150x125	1	613002KH	90,40	613005KH	107,65
6"x2"	168,3x60,3	150x50	1	613002E8	90,40	613005E8	107,65
6"x2 1/2"	168,3x76,1	150x65	1	613002EB	90,40	613005EB	107,65
6"x3"	168,3x88,9	150x80	1	613002EA	90,40	613005EA	107,65
6"x4"	168,3x114,3	150x100	1	613002EC	90,40	613005EC	107,65
6"x5"	168,3x139,7	150x125	1	613002EH	90,40	613005EH	107,65
8"x3"	219,1x88,9	200x80	1	613002MA	183,15	613005MA	217,40
8"x4"	219,1x114,3	200x100	1	613002MC	183,15	613005MC	217,40
8"x5"	219,1x139,7	200x125	1	613002MH	183,15	613005MH	217,40
10"x6"	273,0x168,3	250x150	1	613002NE	350,40	613005NE	421,95

180 CRUZETA

Ø	Ø EXT. mm.	DN		COD. VERMELHO (RAL 3000)	€	COD. GALVANIZADO	€
1 1/2"	48,3	40	8	61800207	17,40	61800507	19,65
2"	60,3	50	4	61800208	25,20	61800508	28,40
2 1/2"	76,1	65	2	6180020B	31,65	6180050B	35,65
3"	88,9	80	2	6180020A	41,45	6180050A	46,90
4"	114,3	100	1	6180020C	66,20	6180050C	75,50
5"	139,7	125	1	6180020H	101,20	6180050H	116,40
6"	168,3	150	1	6180020E	135,35	6180050E	155,60

300 TAMPÃO



Ø	Ø EXT. mm.	DN		COD. VERMELHO (RAL 3000)	€	COD. GALVANIZADO	€
1"	33,7	25	165	63000205	2,30	63000505	2,65
1 1/4"	42,4	32	160	63000206	2,40	63000506	2,90
1 1/2"	48,3	40	160	63000207	2,60	63000507	3,10
2"	60,3	50	96	63000208	4,05	63000508	4,75
2 1/2"	76,1	65	52	6300020B	5,40	6300050B	6,35
3"	88,9	80	36	6300020A	6,20	6300050A	7,30
4"	114,3	100	20	6300020C	9,90	6300050C	11,50
5"	139,7	125	12	6300020H	13,35	6300050H	15,95
6 1/2" O.D	165,1	150	10	6300020K	19,95	6300050K	23,75
6"	168,3	150	10	6300020E	19,65	6300050E	23,45
8"	219,1	200	1	6300020M	30,95	6300050M	36,85
10"	273,0	250	1	6300020N	63,60	6300050N	74,80
12"	323,9	300	1	6300020Q	108,05	6300050Q	127,65

315 TAMPÃO ROSCADO (2") CONCÊNTRICO

Ø	Ø EXT. mm.	DN		COD. VERMELHO (RAL 3000)	€	COD. GALVANIZADO	€
2 1/2"x2"	76,1x60,3	65x50	52	631502B8	6,90	631505B8	8,00
3"x2"	88,9x60,3	80x50	36	631502A8	8,10	631505A8	9,30
4"x2"	114,3x60,3	100x50	20	631502C8	12,50	631505C8	14,95
5"x2"	139,7x60,3	125x50	12	631502H8	18,80	631505H8	21,75
6 1/2" O.Dx2"	165,1x60,3	150x50	10	631502K8	27,95	631505K8	32,05
6"x2"	168,3x60,3	150x50	10	631502E8	27,30	631505E8	31,40

316 TAMPÃO ROSCADO (2") EXCÊNTRICO



Ø	Ø EXT. mm.	DN		COD. VERMELHO (RAL 3000)	€	COD. GALVANIZADO	€
3"x2"	88,9x60,3	80x50	36	631602A8	8,45	631605A8	9,65
4"x2"	114,3x60,3	100x50	20	631602C8	13,45	631605C8	15,35
5"x2"	139,7x60,3	125x50	12	631602H8	19,95	631605H8	22,75
6"x2"	168,3x60,3	150x50	10	631602E8	25,35	631605E8	29,95
8"x2"	219,1x60,3	200x50	3	631602M8	37,80	631605M8	43,00

321 FLANGE ADAPTADORA



Ø	Ø EXT. mm.	DN		COD. VERMELHO (RAL 3000)	€	COD. GALVANIZADO	€
1"	33,7	25	12	63210205	20,20	63210505	24,10
1 1/4"	42,4	32	10	63210206	21,60	63210506	25,80
1 1/2"	48,3	40	8	63210207	22,35	63210507	26,50
2"	60,3	50	4	63210208	23,85	63210508	28,25
2 1/2"	76,1	65	4	6321020B	27,10	6321050B	32,05
3"	88,9	80	5	6321020A	29,50	6321050A	34,85
4"	114,3	100	4	6321020C	37,30	6321050C	44,15
5"	139,7	125	2	6321020H	50,20	6321050H	59,50
6 1/2" O.D	165,1	150	4	6321020K	59,90	6321050K	70,20
6"	168,3	150	4	6321020E	59,55	6321050E	70,00
8"	219,1	200	1	6321020M	91,70	6321050M	108,25
10"	273,0	250	1	6321020N	148,65	6321050N	176,20
12"	323,9	300	1	6321020Q	315,50	6321050Q	374,05
8" PN10	219,1	200	1	6321120M	88,10	6321150M	101,65
10" PN10	273,0	250	1	6321120N	142,30	6321150N	162,60
12" PN10	323,9	300	1	6321120Q	308,90	6321150Q	349,60

322 FLANGE BIPARTIDA



Ø	Ø EXT. mm.	DN		COD. VERMELHO (RAL 3000)	€	COD. GALVANIZADO	€
1 1/2"	48,3	40	16	63220207	19,00	63220507	21,85
2"	60,3	50	14	63220208	23,10	63220508	26,50
2 1/2"	76,1	65	12	6322020B	24,75	6322050B	28,45
3"	88,9	80	12	6322020A	28,30	6322050A	32,50
4"	114,3	100	10	6322020C	35,95	6322050C	41,30
5"	139,7	125	7	6322020H	48,40	6322050H	55,65
6 1/2" O.D	165,1	150	7	6322020K	55,60	6322050K	63,90
6"	168,3	150	7	6322020E	60,30	6322050E	69,40
8"	219,1	200	2	6322020M	105,70	6322050M	121,55
10"	273,0	250	2	6322020N	176,20	6322050N	202,55
12"	323,9	300	2	6322020Q	298,10	6322050Q	342,80

600 VÁLVULA DE COMPORTA RANHURADA (Volante NRS)

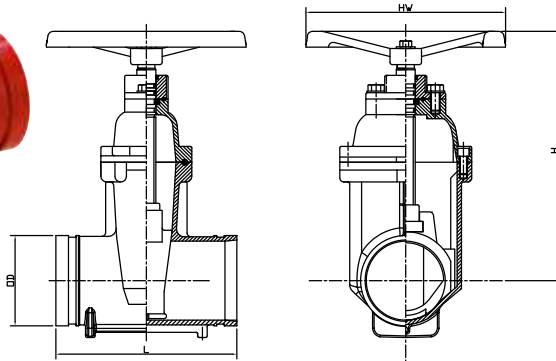

TUBO DE AÇO			DIMENSÕES			COD.	€
Ø	Ø D mm.	DN	L mm.	H mm.	Ø HW mm.		
2"	60,3	50	178	218	180	6V600208	151,95
2 1/2"	76,1	65	190	230	180	6V60020B	181,25
3"	88,9	80	203	281	200	6V60020A	265,40
4"	114,3	100	229	316	254	6V60020C	358,15
5"	139,7	125	254	393	280	6V60020H	787,25
6"	168,3	150	267	420	305	6V60020E	817,70
8"	219,1	200	292	490	350	6V60020M	1.121,00

CARACTERÍSTICAS TÉCNICAS

Fabrico s/ BS 5163.
 Ranhuras s/ ISO 6182.
 Pressão de serviço: PN16 (230 PSI; 1.6 Mpa).
 Temperaturas de serviço: 0° C a 80° C.
 Aplicações: Rede de Incêndios, Serviços de Água, Rega.
 Aprovadas por UL e FM.

COMPONENTES

Corpo e Tampão: Fundição dúctil EN-GJS-450-10
Comporta em Cunha: Fundição dúctil EN-GJS-450-10
Revestimento da Cunha: EPDM
Eixo: Aço inoxidável 2Cr13
O-Ring: NBR
Volante: Fundição dúctil EN-GJS-450-10
Prensa estopa: Fundição dúctil EN-GJS-450-10



660 VÁLVULA COMPORTA FLANGEADA (Volante, NRS)

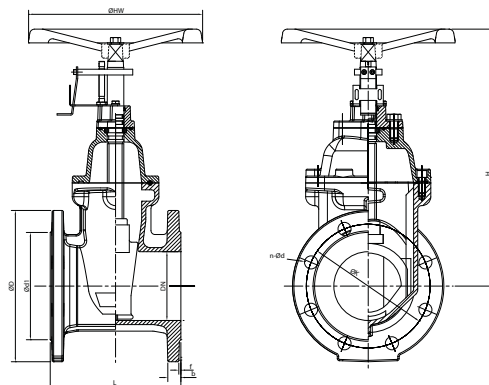

TUBO DE AÇO			DIMENSÕES									COD.	€
Ø	Ø D mm.	DN	L (F4) mm.	D mm.	K mm.	d1 mm.	H mm.	HW mm.	b mm.	f mm.	n-Ød mm.		
2"	60,3	50	150	165	125	99	282	180	19,0	3	4x19	6V660208	352,60
2 1/2"	76,1	65	170	185	145	118	290	180	19,0	3	4x19	6V66020B	391,55
3"	88,9	80	180	200	160	132	331	200	19,0	3	8x19	6V66020A	437,35
4"	114,3	100	190	220	180	156	366	254	19,0	3	8x19	6V66020C	569,05
5"	139,7	125	200	250	210	184	447	280	19,0	3	8x19	6V66020H	921,65
6"	168,3	150	210	285	240	211	490	305	19,0	3	8x23	6V66020E	1.059,05
8"	219,1	200	230	340	295	266	560	350	20,0	3	12x23	6V66020M	1.396,80
10"	273,0	250	250	405	355	319	706	450	22,0	3	12x28	6V66020N	2.518,80
12"	329,9	300	270	460	410	370	802	450	24,5	4	12x28	6V66020Q	3.892,65

CARACTERÍSTICAS TÉCNICAS

Ligações flangeadas conforme EN 1092-2.
 Pressão de serviço: PN10/16 (150/230 PSI; 1.0/1.6 Mpa).
 Temperatura de serviço: 0° C a 80° C.
 Aplicações: Rede de Incêndios, Serviços de Água, Rega.
 Aprovadas por VdS, UL e FM.

COMPONENTES

Corpo e Tampão: Fundição dúctil EN-GJS-450-10
Comporta em Cunha: Fundição dúctil EN-GJS-450-10
Revestimento da Cunha: EPDM
Eixo*: Aço Inoxidável 2Cr13
O-Ring: NBR
Volante: Fundição dúctil EN-GJS-450-10
Prensa estopa: Fundição dúctil EN-GJS-450-10



(Ref. 6VSWITC1), ver página 44.

* Possibilidade de incorporar dispositivo eletrônico de controle de abertura.

610

VÁLVULA COMPORTA RANHURADA (RS- Fuso Ascendente Pré-Ranhurado)



(Ref. 6VSWITC2), ver página 44.

* Possibilidade de incorporar dispositivo eletrónico de controlo de abertura.

TUBO DE AÇO			DIMENSÕES				COD.	€
Ø	Ø D mm.	DN	L mm.	H1 FECHADA mm.	H2 ABERTA mm.	Ø HW mm.		
2"	60,3	50	178	323	373	180	6V610208	195,20
2 1/2"	76,1	65	190	343	408	180	6V61020B	231,85
3"	88,9	80	203	370	450	200	6V61020A	266,60
4"	114,3	100	229	442	542	254	6V61020C	357,55
5"	139,7	125	254	540	665	280	6V61020H	679,95
6"	168,3	150	267	608	758	305	6V61020E	706,30
8"	219,1	200	292	720	920	350	6V61020M	972,35

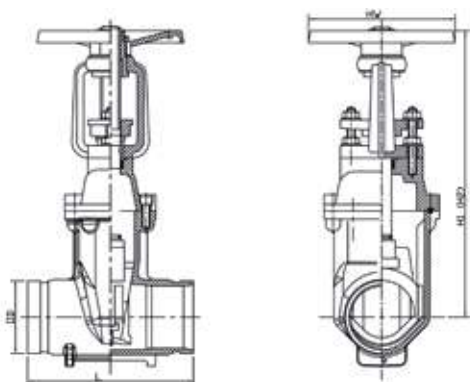

CARACTERÍSTICAS TÉCNICAS

Fabrico s/ BS 5163.
 Ranhuras s/ ISO 6182
 Pressão de serviço: PN16 (230 PSI; 1.6 Mpa).
 Temperaturas de serviço: 0° C a 80° C.
 Aplicações: Rede de Incêndios, Serviços de Água, Rega.
 Aprovadas por UL e FM.

COMPONENTES

Corpo, Tampa e Balanço: Fundição dúctil EN-GJS-450-10
Comporta em Cunha: Fundição dúctil EN-GJS-450-10
Revestimento da Cunha: EPDM
Eixo*: Aço Inoxidável 2Cr13
O-Ring: NBR
Volante: Fundição dúctil EN-GJS-450-10
Prensa estopa: Fundição dúctil EN-GJS-450-10

SISTEMA
RANHURADO

670

VÁLVULA COMPORTA FLANGEADA (Volante, RS Fuso Ascendente Pré- Ranhurado)



(Ref. 6VSWITC2), ver página 44.

* Possibilidade de incorporar dispositivo eletrónico de controlo de abertura.

TUBO DE AÇO							DIMENSÕES						COD.	€
Ø	Ø D mm.	DN	L (F4) mm.	D mm.	K mm.	d1 mm.	H1 FECHADA mm.	H2 ABERTA mm.	HW mm.	b mm.	f mm.	n-Ød mm.		
2"	60,3	50	150	165	125	99	323	373	180	19,0	3	4x19	6V670208	429,35
2 1/2"	76,1	65	170	185	145	118	343	408	180	19,0	3	4x19	6V67020B	480,85
3"	88,9	80	180	200	160	132	370	450	200	19,0	3	8x19	6V67020A	520,95
4"	114,3	100	190	220	180	156	442	542	254	19,0	3	8x19	6V67020C	652,60
5"	139,7	125	200	250	210	184	540	665	280	19,0	3	8x19	6V67020H	1.104,85
6"	168,3	150	210	285	240	211	608	758	305	19,0	3	8x23	6V67020E	1.259,40
8"	219,1	200	230	340	295	266	720	920	350	20,0	3	12x23	6V67020M	1.660,10
10"	273,0	250	250	405	355	319	940	1190	450	22,0	3	12x28	6V67020N	3.262,95
12"	329,9	300	270	460	410	370	1065	1365	450	24,5	4	12x28	6V67020Q	4.694,10

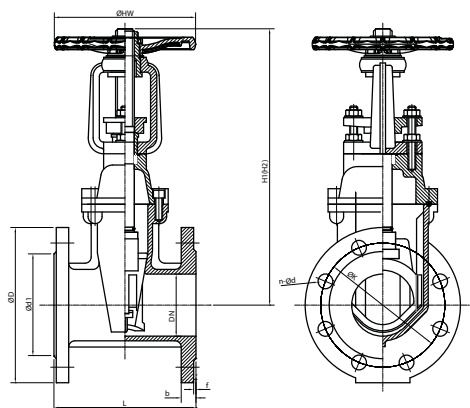

CARACTERÍSTICAS TÉCNICAS

Ligações flangeadas conforme EN 1092-2.
 Pressão de serviço: PN10/16 (150/230 PSI; 1.0/1.6 Mpa).
 Temperatura de serviço: 0° C a 80° C.
 Aplicações: Rede de Incêndios, Serviços de Água, Rega.
 Aprovadas por VdS, UL e FM.

COMPONENTES

Corpo, Tampa e Balanço: Fundição dúctil EN-GJS-450-10
Comporta em Cunha: Fundição dúctil EN-GJS-450-10
Revestimento da Cunha: EPDM
Eixo*: Aço inoxidável 2Cr13
O-Ring: NBR
Volante: Fundição dúctil EN-GJS-450-10
Prensa estopa: Fundição dúctil EN-GJS-450-10

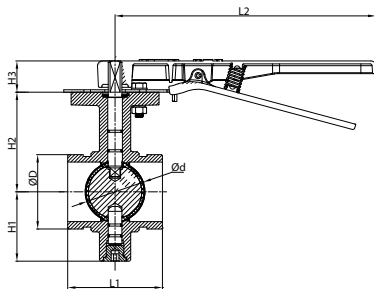
620 VÁLVULA BORBOLETA RANHURADA (MANÍPULO)

TUBO DE AÇO			DIMENSÕES						COD.	€
Ø	Ø D mm.	DN	Ø d mm.	H1 mm.	H2 mm.	H3 mm.	L1 mm.	L2 mm.		
2"	60,3	50	50,3	65	89	32	81	267	6V620208	70,20
2 1/2"	76,1	65	60,8	71	102	32	97	267	6V62020B	90,90
3"	88,9	80	76,0	81	109	32	97	267	6V62020A	98,25
4"	114,3	100	98,5	95	128	32	116	267	6V62020C	133,60
5"	139,7	125	122,6	111	141	32	148	267	6V62020H	179,95
6"	168,3	150	148,0	133	153	32	148	267	6V62020E	248,35
8"	219,1	200	199,0	164	184	45	133	356	6V62020M	488,80

CARACTERÍSTICAS TÉCNICAS

Fabrico s/ MSS SP-67.
 Ranhuras s/ ISO 6182
 Flange para montagem do atuador: ISO 5211.
 Pressão de serviço: PN16 (230 PSI; 1.6 Mpa).
 Temperatura de serviço: 0° C a 80° C.
 Aplicações: Rede de Incêndios, Serviços de Água, Rega.

COMPONENTES

Corpo: Fundição dúctil EN-GJS-450-10
Disco: Fundição dúctil EN-GJS-450-10
Revestimento do Disco: EPDM
Manípulo: Fundição dúctil EN-GJS-450-10
O-Ring: NBR
Eixo: Aço inoxidável SS431

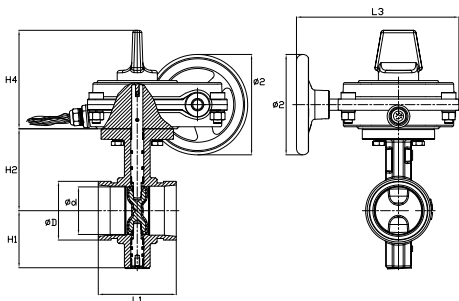
630 VÁLVULA BORBOLETA RANHURADA (VOLANTE)

TUBO DE AÇO			DIMENSÕES							COD.	€
Ø	Ø D mm.	DN	Ø d mm.	Ø 2 mm.	H1 mm.	H2 mm.	H4 mm.	L1 mm.	L3 mm.		
2"	60,3	50	50,3	125	65	89	123	81	202	6V630208	191,80
2 1/2"	76,1	65	60,8	125	71	102	123	97	202	6V63020B	206,60
3"	88,9	80	76,0	125	81	109	123	97	202	6V63020A	216,25
4"	114,3	100	98,5	125	95	128	123	116	202	6V63020C	245,85
5"	139,7	125	122,6	125	111	141	123	148	202	6V63020H	284,15
6"	168,3	150	148,0	225	133	153	123	148	202	6V63020E	358,15
8"	219,1	200	199,0	225	164	184	123	133	260	6V63020M	724,30
10"	273,0	250	252,0	225	196	216	123	159	260	6V63020N	1.058,95

CARACTERÍSTICAS TÉCNICAS

Fabrico s/ MSS SP-67.
 Corpo: Fundição dúctil EN-GJS-450-10.
 Ranhuras s/ ISO 6182.
 Flange para montagem do atuador: ISO 5211.
 Pressão de serviço: PN16 (230 PSI; 1.6 Mpa).
 Temperaturas de serviço: 0° C a 80° C.
 Aplicações: Rede de Incêndios, Serviços de Água, Rega.
 Aprovadas por VdS, UL e FM.

COMPONENTES

Corpo: Fundição dúctil EN-GJS-450-10
Disco: Fundição dúctil EN-GJS-450-10
Revestimento do Disco: EPDM
Volante: Fundição dúctil EASTM A536
O-Ring: NBR
Eixo: Aço Inoxidável SS431



VOL VOLANTE (SUBSTITUIÇÃO) PARA 630



TUBO DE AÇO			DIMENSÕES				COD.	€
Ø	Ø D mm.	DN	Ø 1 mm.	L4 mm.	L7 mm.	L8 mm.		
2" - 2 1/2" - 3"	60,3 - 76,1 - 88,9	50 - 65 - 80	150	210	54	114	6VVOL8BA	91,60
4"	114,3	100	150	210	54	114	6VVOL00C	94,05
5" - 6"	139,7 - 168,3	125 - 150	150	210	54	114	6VVOLHKE	97,80
8"	219,1	200	300	305	69	167	6VVOL00M	190,70
10"	273,0	250	300	305	69	167	6VVOL00N	196,35

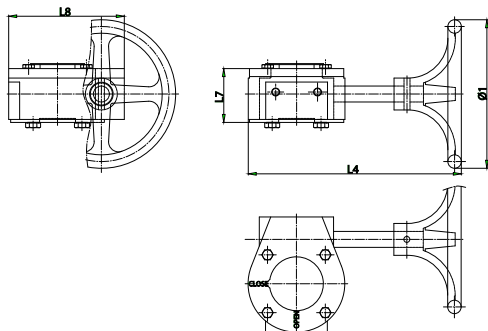

COMPONENTES

Corpo: Fundição dúctil EN-GJS-450-10
Volante: Fundição dúctil EN-GJS-450-10
Eixo: Aço Inoxidável UNS S43100 (SS431)

635 VÁLVULA BORBOLETA RANHURADA COM FIM DE CURSO (VOLANTE)



TUBO DE AÇO			DIMENSÕES							COD.	€
Ø	Ø D mm.	DN	Ø d mm.	Ø 2 mm.	H1 mm.	H2 mm.	H4 mm.	L1 mm.	L3 mm.		
2"	60,3	50	50,3	125	65	89	123	81	202	6V635208	280,60
2 1/2"	76,1	65	60,8	125	71	102	123	97	202	6V63520B	298,95
3"	88,9	80	76,0	125	81	109	123	97	202	6V63520A	311,20
4"	114,3	100	98,5	125	95	128	123	116	202	6V63520C	347,80
5"	139,7	125	122,6	125	111	141	123	148	202	6V63520H	402,80
6"	168,3	150	148,0	225	133	153	123	148	202	6V63520E	518,65
8"	219,1	200	199,0	225	164	184	123	133	260	6V63520M	884,80
10"	273,0	250	252,0	225	196	216	123	159	260	6V63520N	1.216,80

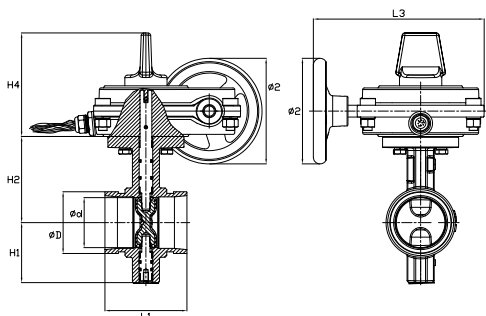

CARACTERÍSTICAS TÉCNICAS

Fabrico s/ MSS SP-67.
 Ranhuras s/ ISO 6182.
 Flange para montagem do atuador: ISO 5211.
 Pressão de serviço: PN16 (230 PSI; 1.6 Mpa).
 Temperaturas de serviço: 0° C a 80° C.
 Aplicações: Rede de Incêndios,
 Serviços de Água, Rega.
 Aprovadas por VdS, UL e FM.

COMPONENTES

Corpo: Fundição dúctil EN-GJS-450-10
Disco: Fundição dúctil EN-GJS-450-10
Revestimento do Disco: EPDM
Volante: Fundição dúctil ASTM A536
O-Ring: NBR
Eixo: Aço Inoxidável SS431

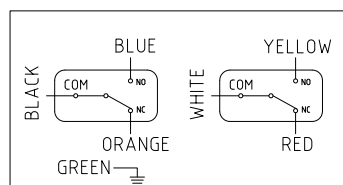

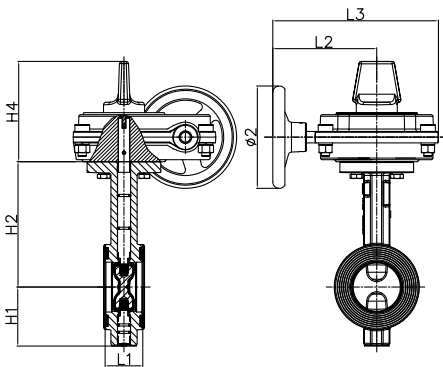
636 VÁLVULA BORBOLETA TIPO WAFER (VOLANTE)

TUBO DE AÇO			DIMENSÕES							COD.	€
Ø	Ø D mm.	DN	Ø 2 mm.	H1 mm.	H2 mm.	H4 mm.	L1 (±2) mm.	L2 mm.	L3 mm.		
2"	60,3	50	125	65	140,5	122,5	43	127,0	202	6V636208	247,55
2 1/2"	76,1	65	125	71	153,0	122,5	46	127,0	202	6V63620B	259,05
3"	88,9	80	125	81	157,5	122,5	46	127,0	202	6V63620A	269,65
4"	114,3	100	125	95	176,0	122,5	52	127,0	202	6V63620C	305,50
5"	139,7	125	125	111	191,0	122,5	56	127,0	202	6V63620H	347,60
6"	168,3	150	225	133	202,5	122,5	56	139,5	215	6V63620E	449,40
8"	219,1	200	225	164	243,5	122,5	60	198,5	274	6V63620M	766,65
10"	273,0	250	225	196	273,0	122,5	68	198,5	274	6V63620N	842,65
12"	323,9	300	225	226	311,0	132,0	78	202,0	293	6V63620Q	1.116,50

CARACTERÍSTICAS TÉCNICAS

Fabrico s/ EN 593.
 Flange para montagem do atuador: ISO 5211.
 Pressão de serviço: PN10/16/25
 (150/230/360 PSI; 1.0/1.6/2.5 MPa).
 Aplicações: Rede de Incêndios, Serviços de Água, Rega.
 Aprovadas por UL e FM.

COMPONENTES

Corpo: Fundição dúctil EN-GJS-450-10
Disco: Fundição dúctil EN-GJS-450-10
Revestimento do Disco: EPDM
Volante: Fundição dúctil N-GJS-450-10
O-Ring: NBR
Eixo: Aço Inoxidável UNS S43100 (SS431)

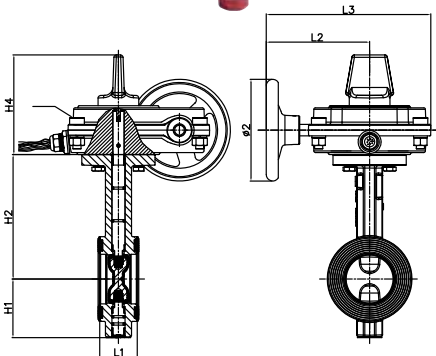
637 VÁLVULA BORBOLETA TIPO WAFER COM FIM DE CURSO (VOLANTE)

TUBO DE AÇO			DIMENSÕES							COD.	€
Ø	Ø D mm.	DN	Ø 2 mm.	H1 mm.	H2 mm.	H4 mm.	L1 (±2) mm.	L2 mm.	L3 mm.		
2"	60,3	50	125	65	140,5	122,5	43	127,0	202	6V637208	269,05
2 1/2"	76,1	65	125	71	153,0	122,5	46	127,0	202	6V63720B	281,55
3"	88,9	80	125	81	157,5	122,5	46	127,0	202	6V63720A	293,05
4"	114,3	100	125	95	176,0	122,5	52	127,0	202	6V63720C	332,00
5"	139,7	125	125	111	191,0	122,5	56	127,0	202	6V63720H	377,80
6"	168,3	150	225	133	202,5	122,5	56	139,5	215	6V63720E	488,45
8"	219,1	200	225	164	243,5	122,5	60	198,5	274	6V63720M	833,30
10"	273,0	250	225	196	273,0	122,5	68	198,5	274	6V63720N	915,90
12"	323,9	300	225	226	311,0	132,0	78	202,0	293	6V63720Q	1.213,60

CARACTERÍSTICAS TÉCNICAS

Fabrico s/ EN 593.
 Flange para montagem do atuador: ISO 5211.
 Pressão de serviço: PN10/16/25
 (150/230/360 PSI; 1.0/1.6/2.5 MPa).
 Aplicações: Rede de Incêndios, Serviços de Água, Rega.
 Aprovadas por UL e FM.

COMPONENTES

Corpo: Fundição dúctil EN-GJS-450-10
Disco: Fundição dúctil EN-GJS-450-10
Revestimento do Disco: EPDM
Volante: Fundição dúctil N-GJS-450-10
O-Ring: NBR
Eixo: Aço Inoxidável UNS S43100 (SS431)

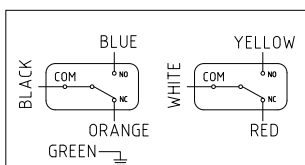

640 VÁLVULA DE RETENÇÃO DE CHARNEIRA RANHURADA



TUBO DE AÇO			DIMENSÕES		COD.	€
Ø	Ø D mm.	DN	L mm.			
2"	60,3	50	172		6V640208	108,30
2 1/2"	76,1	65	184		6V64020B	112,65
3"	88,9	80	197		6V64020A	154,35
4"	114,3	100	210		6V64020C	242,85
5"	139,7	125	248		6V64020H	427,75
6"	168,3	150	325		6V64020E	469,90
8"	219,1	200	372		6V64020M	754,25
10"	273,0	250	457		6V64020N	1.202,15
12"	323,9	300	535		6V64020Q	1.717,35

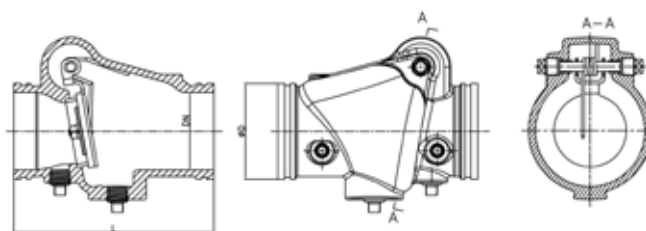

CARACTERÍSTICAS TÉCNICAS

Ranhuradas s/ ISO 6182.
 Pressão de serviço: PN16 (230 PSI; 1.6 Mpa).
 Temperaturas de serviço: 0° C a 80° C.
 Aplicações: Rede de Incêndios, Serviços de Água, Rega.
 Aprovadas por VdS, UL e FM.

COMPONENTES

Corpo: Fundição dúctil EN-GJS-450-10
Mola: Aço inoxidável UNS S30400 (SS304)
Disco: (DN50-DN100) Aço inoxidável UNS S30400 (SS304)
Disco: (DN125-DN200) Fundição dúctil EN-GJS-450-10
Vedante: EPDM
Assento: Bronze s/ASTM B62 UNS C83600



645 VÁLVULA DE RETENÇÃO DE CHARNEIRA FLANGEADA



TUBO DE AÇO			DIMENSÕES							COD.	€	
Ø	Ø D mm.	DN	L (F4) mm.	D mm.	K mm.	d1 mm.	H mm.	b mm.	f mm.			n-Ød mm.
2"	60,3	50	203	165	125	99	133	19,0	3	4x19	6V645208	314,85
2 1/2"	76,1	65	216	185	145	118	150	19,0	3	4x19	6V64520B	343,45
3"	88,9	80	241	200	160	132	150	19,0	3	8x19	6V64520A	417,90
4"	114,3	100	292	220	180	156	218	19,0	3	8x19	6V64520C	563,30
5"	139,7	125	330	250	210	184	245	19,0	3	8x19	6V64520H	770,50
6"	168,3	150	356	285	240	211	290	19,0	3	8x23	6V64520E	1.001,80
8"	219,1	200	495	340	295	266	330	20,0	3	12x23	6V64520M	1.688,75
10"	273,0	250	622	405	355	319	350	22,0	3	12x28	6V64520N	2.655,05
12"	329,9	300	698	460	410	370	376	24,5	4	12x28	6V64520Q	3.751,85

CARACTERÍSTICAS TÉCNICAS

Ligações flangeadas conforme EN 1092-2.
 Pressão de serviço: PN10/16
 (150/230 PSI; 1.0/1.6 MPa).
 Temperatura de serviço: 0° C a 80° C.
 Aplicações: Rede de Incêndios,
 Serviços de Água, Rega.
 Aprovadas por UL e FM.

COMPONENTES

Corpo e Tampão: Fundição dúctil EN-GJS-450-10
Charneira: Fundição dúctil EN-GJS-450-10
Disco: Fundição dúctil EN-GJS-450-10
Assento: Bronze
O-ring: EPDM

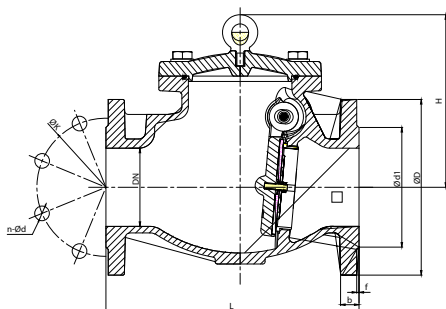

SW1 FIM DE CURSO



DN	DESCRIÇÃO	COD.	€
50 a 300	Fim de curso para Válvulas de Comporta NRS tipo 660	6VSWITC1	85,60

SW2 FIM DE CURSO



DN	DESCRIÇÃO	COD.	€
50 a 300	Fim de curso para Válvulas de Comporta RS tipo 610 e 670	6VSWITC2	320,50

BOBINES RANHURADAS

Ver na página 66



LIGAÇÕES FLÉXIVEIS PARA SPRINKLERS



- 1 - (1 pc) Ligação de entrada (rosca R1xM33)
- 2 - (1 pc) Mangueira DN25 (Trançada ou corrugada) de comprimento variável (rosca M33xM33).
- 3 - (1 pc) Ligação com redutor de saída (rosca M33x1/2" NPT ou M33x3/4" NPT)
- 4 - (1 pc) Barra de suporte comprimento 635 mm.
- 5 - Suporte tipo borboleta comprimento 70 mm. altura (1pc central e 2 pcs laterais).

KIT COM LIGAÇÕES FLÉXIVEIS TRANÇADAS



SAÍDA 1/2" NPT			
COD.	COMPRIM mm.	KITS CAIXA	€/KIT
LFB30700	700	10	50,70
LFB31000	1000	10	56,15
LFB31200	1200	10	60,00
LFB31500	1500	10	65,55
LFB31800	1800	10	71,90

SAÍDA 3/4" NPT			
COD.	COMPRIM mm.	KITS CAIXA	€/KIT
LFB40700	700	10	50,70
LFB41000	1000	10	56,15
LFB41200	1200	10	60,00
LFB41500	1500	10	65,55
LFB41800	1800	10	71,90

KIT COM LIGAÇÕES FLÉXIVEIS CORRUGADAS



SAÍDA 1/2" NPT			
COD.	COMPRIM mm.	KITS CAIXA	€/KIT
LFU30700	700	10	36,40
LFU31000	1000	10	39,05
LFU31200	1200	10	40,65
LFU31500	1500	10	43,20
LFU31800	1800	10	46,25

SAÍDA 3/4" NPT			
COD.	COMPRIM mm.	KITS CAIXA	€/KIT
LFU40700	700	10	36,40
LFU41000	1000	10	39,05
LFU41200	1200	10	40,65
LFU41500	1500	10	43,20
LFU41800	1800	10	46,25

ACESSÓRIOS



COD.	DESCRIÇÃO		€/KIT
LFAT0070	KIT SUPORTE COM PARAFUSO (1 CENTRAL + 2 LATERAIS) 70 mm.	70 1	10,60
LFAT0102	KIT SUPORTE COM PARAFUSO (1 CENTRAL + 2 LATERAIS) 102 mm.	50 1	15,05
LFAM0070	KIT SUPORTE C/PORCA DE ORELHAS (1 CENTRAL + 2 LATERAIS) 70 mm.	70 1	11,50
LFAM0102	KIT SUPORTE C/ PORCA DE ORELHAS (1 CENTRAL + 2 LATERAIS) 102 mm.	50 1	15,75

COD.	DESCRIÇÃO		€
LFCR0385	JOELHO DE REDUÇÃO MxF (M33/DN25 X 1/2" NPT) 85 mm.	128 1	14,45
LFCR3115	JOELHO DE REDUÇÃO MxF (M33/DN25 X 1/2" NPT) 115 mm.	96 1	17,25
LFCR0485	JOELHO DE REDUÇÃO MxF (M33/DN25 X 3/4" NPT) 85 mm.	128 1	14,20
LFCR4115	JOELHO DE REDUÇÃO MxF (M33/DN25 X 3/4" NPT) 115 mm.	96 1	17,10

COD.	DESCRIÇÃO		€
LFBS0635	BARRA DE SUPORTE GALVANIZADA 635 mm.	100 10	4,40
LFBS1270	BARRA DE SUPORTE GALVANIZADA 1270 mm.	50 10	9,15

Para outros acessórios por favor consulte.

ACESSÓRIOS DE **AÇO**

A ATUSA tornou-se num fornecedor de referência na família do aço. Entendemos que o ferro e o aço são produtos relacionados e, portanto devem caminhar juntos.

Estamos presentes no universo do aço com uma gama de produtos em constante crescimento.

A close-up photograph of a metal pipe, showing its textured surface and the dark interior. The background is a vibrant green with a subtle gradient. The ATUSA logo is positioned in the upper right corner.

ATUSA

ACESSÓRIOS
DE AÇO

ACESSÓRIOS
AÇO

**ACESSÓRIOS DE AÇO PARA SOLDAR
NORMA EN**

CURVA 3D EN 10253-1 - AÇO S235

DIMENSÕES		45°		90°		90° GALVA.		90° COM SOLDADURA		180°	
Ø	Ø EXT. x ESPESSURA mm.	COD.	€	COD.	€	COD.	€	COD.	€	COD.	€
1/2"	21,3 x 2,0	C3450021	1,45	C3XXXX21	1,45	C3GXXX21	1,65			C3180021	3,60
3/4"	26,9 x 2,3	C3450027	1,45	C3XXXX27	1,45	C3GXXX27	1,80	C3HXXX27	1,30	C3180027	3,60
1"	33,7 x 2,6	C3450033	1,75	C3XXXX33	1,85	C3GXXX33	2,15	C3HXXX33	1,45	C3180033	4,15
	38,0 x 2,6			C3XXXX38	3,45						
1 1/4"	42,4 x 2,6	C3450042	2,25	C3XXXX42	2,35	C3GXXX42	3,05	C3HXXX42	1,85	C3180042	5,70
	44,5 x 2,6			C3XXXX44	3,80						
1 1/2"	48,3 x 2,6	C3450048	2,80	C3XXXX48	2,90	C3GXXX48	3,95	C3HXXX48	2,30	C3180048	7,00
	* 51,0 x 2,6			C3XXXX51	4,70						
	54,0 x 2,6			C3XXXX54	6,80						
	57,0 x 2,9			C3XXXX57	5,30						
2"	60,3 x 2,9	C3450060	4,50	C3XXXX60	4,50	C3GXXX60	6,60	C3HXXX60	3,70	C3180060	11,15
	70,0 x 2,9			C3XXXX70	8,45	C3GXXX70	10,45				
2 1/2"	76,1 x 2,9	C3450076	6,60	C3XXXX76	7,00	C3GXXX76	10,50	C3HXXX76	5,80	C3180076	16,35
3"	88,9 x 3,2	C3450089	9,55	C3XXXX89	10,20	C3GXXX89	15,75	C3HXXX89	8,45	C3180089	24,10
3 1/2"	101,6 x 3,6	C3450101	16,75	C3XXX101	19,90	C3GXX101	25,55	C3HXX101	17,60	C3180101	46,45
	108,0 x 3,6			C3XXX108	22,60	C3GXX108	28,90				
4"	114,3 x 3,6	C3450114	17,25	C3XXX114	19,10	C3GXX114	29,90	C3HXX114	15,75	C3180114	47,65
	133,0 x 4,0			C3XXX133	38,20	C3GXX133	49,95				
5"	139,7 x 4,0	C3450139	29,45	C3XXX139	32,60	C3GXX139	51,70	C3HXX139	26,55	C3180139	81,40
	159,0 x 4,5			C3XXX159	55,15	C3GXX159	75,55				
6"	168,3 x 4,5	C3450168	42,45	C3XXX168	47,30	C3GXX168	78,30	C3HXX168	38,75	C3180168	118,35
7"	193,7 x 5,6			C3XXX193	158,55						
8"	219,1 x 6,3	C3450219	89,95	C3XXX219	111,70	C3GXX219	181,20				
	244,5 x 6,3			C3XXX244	388,70						
10"	273,0 x 6,3	C3450273	159,85	C3XXX273	190,45	C3GXX273	306,35				
12"	323,9 x 7,1	C3450324	260,15	C3XXX324	287,45						
14"	355,6 x 8,0	C3450355	384,05	C3XXX355	442,75						
16"	406,4 x 8,8	C3450406	543,05	C3XXX406	615,25						
18"	* 457,2 x 9,53			C3XXX457	1.183,65						
20"	* 508,0 x 9,53			C3XXX508	1.666,35						
24"	* 609,6 x 9,53			C3XXX609	2.949,20						

* Não corresponde à Norma EN 10253



CURVA 5D EN 10253-1 - AÇO S235

DIMENSÕES		45°		90°		90° GALVA.		180°	
Ø	Ø EXT. x ESPESSURA mm.	COD.	€	COD.	€	COD.	€	COD.	€
1/2"	21,3 x 2,0	C5450021	3,85	C5XXXX21	3,85				
3/4"	26,9 x 2,3	C5450027	4,70	C5XXXX27	4,70	CSGXXX27	4,60	C5180027	12,00
1"	33,7 x 2,6	C5450033	4,70	C5XXXX33	4,70	CSGXXX33	5,45	C5180033	12,00
1 1/4"	42,4 x 2,6	C5450042	6,20	C5XXXX42	6,20	CSGXXX42	7,50	C5180042	16,25
1 1/2"	48,3 x 2,6	C5450048	7,95	C5XXXX48	7,95	CSGXXX48	9,70	C5180048	20,25
2"	60,3 x 2,9	C5450060	11,15	C5XXXX60	11,15	CSGXXX60	13,95	C5180060	28,60
	70,0 x 2,9			C5XXXX70	38,20				
2 1/2"	76,1 x 2,9	C5450076	16,50	C5XXXX76	16,50	CSGXXX76	22,50	C5180076	41,50
3"	88,9 x 3,2	C5450089	23,85	C5XXXX89	25,65	CSGXXX89	34,55	C5180089	66,25
3 1/2"	101,6 x 3,6	C5450101	52,45	C5XXX101	57,50				
	108,0 x 3,6			C5XXX108	57,60				
4"	114,3 x 3,6	C5450114	46,40	C5XXX114	49,85	CSGXX114	64,10	C5180114	128,55
	133,0 x 4,0			C5XXX133	109,30				
5"	139,7 x 4,0			C5XXX139	85,10	CSGXX139	116,25		
	159,0 x 4,5			C5XXX159	169,80				
6"	168,3 x 4,5			C5XXX168	140,75	CSGXX168	179,05		
8"	219,1 x 6,3			C5XXX219	352,95	CSGXX219	438,25		
10"	273,0 x 6,3			C5XXX273	724,75	CSGXX273	797,35		
12"	323,9 x 7,1			C5XXX324	1.218,95				

TAMPÃO EN 10253-1 - AÇO S235

Ø	Ø EXT. mm.	ESPESSURA mm.	COD.	€
3/4"	* 26,9	2,3	CCXXXX27	0,85
1"	33,7	2,6	CCXXXX34	0,85
1 1/4"	42,4	2,6	CCXXXX42	0,90
1 1/2"	48,3	2,6	CCXXXX48	0,95
2"	60,3	2,9	CCXXXX60	1,25
	70,0	2,9	CCXXXX70	1,75
2 1/2"	76,1	2,9	CCXXXX76	1,80
3"	88,9	3,2	CCXXXX89	2,15
3 1/2"	101,6	3,6	CCXXX101	6,05
	108,0	3,6	CCXXX108	6,45
4"	114,3	3,6	CCXXX114	6,05
	133,0	4,0	CCXXX133	8,40

Ø	Ø EXT. mm.	ESPESSURA mm.	COD.	€
5"	139,7	4,0	CCXXX140	9,25
	159,0	4,5	CCXXX159	16,05
6"	168,3	4,5	CCXXX168	16,70
7"	193,7	5,6	CCXXX193	28,45
8"	219,1	6,3	CCXXX219	31,10
	244,5	6,3	CCXXX245	39,05
10"	273,0	6,3	CCXXX273	45,55
12"	323,9	7,1	CCXXX324	63,70
14"	355,6	8,0	CCXXX356	110,55
16"	406,4	8,8	CCXXX406	149,10
18"	* 457,0	8,0	CCXXX457	261,20
20"	* 508,0	8,0	CCXXX508	290,30
24"	* 610,0	8,0	CCXXX610	521,15

* Não corresponde à Norma EN 10253

TÊ EN 10253-1 - AÇO S235

Ø	Ø EXT. mm.	ESPESSURA mm.	COD.	€
1/2"	21,3	2,0	CTDXXX21	4,90
3/4"	26,9	2,3	CTDXXX27	5,55
1"	33,7	2,6	CTDXXX33	5,95
1 1/4"	42,4	2,6	CTDXXX42	7,20
1 1/2"	48,3	2,6	CTDXXX48	9,15
2"	60,3	2,9	CTDXXX60	11,70
2 1/2"	76,1	2,9	CTDXXX76	18,70
3"	88,9	3,2	CTDXXX89	26,15
3 1/2"	101,6	3,6	CTDXX101	55,75

Ø	Ø EXT. mm.	ESPESSURA mm.	COD.	€
4"	114,3	3,6	CTDXX114	38,65
5"	139,7	4,0	CTDXX139	61,00
6"	168,3	4,5	CTDXX168	85,85
8"	219,1	6,3	CTDXX219	197,60
10"	273,0	6,3	CTDXX273	403,30
12"	323,9	7,1	CTDXX323	621,15
14"	355,6	8,0	CTDXX355	779,65
16"	406,4	8,8	CTDXX406	1.113,75



REDUÇÃO CONCÊNTRICA EN 10253-1 SERIE 2 - AÇO S235

Ø	Ø EXT. mm.	ESPESSURA mm.	COD.	€
3/4" x 1/2"	26,9 x 21,3	2,3 - 2,0	CRXX2721	3,40
1" x 1/2"	33,7 x 21,3	2,6 - 2,0	CRXX3321	3,40
1" x 3/4"	33,7 x 26,9	2,6 - 2,3	CRXX3327	3,05
1 1/4" x 1/2"	42,4 x 21,3	2,6 - 2,0	CRXX4221	5,65
1 1/4" x 3/4"	42,4 x 26,9	2,6 - 2,3	CRXX4227	3,80
1 1/4" x 1"	42,4 x 33,7	2,6 - 2,6	CRXX4233	3,30
1 1/2" x 1/2"	* 48,3 x 21,3	2,6 - 2,0	CRXX4821	7,60
1 1/2" x 3/4"	48,3 x 26,9	2,6 - 2,3	CRXX4827	4,90
1 1/2" x 1"	48,3 x 33,7	2,6 - 2,6	CRXX4833	4,05
1 1/2" x 1 1/4"	48,3 x 42,4	2,6 - 2,6	CRXX4842	3,50
2" x 3/4"	* 60,3 x 26,9	2,9 - 2,3	CRXX6027	8,30
2" x 1"	60,3 x 33,7	2,9 - 2,6	CRXX6033	5,50
2" x 1 1/4"	60,3 x 42,4	2,9 - 2,6	CRXX6042	5,05
2" x 1 1/2"	60,3 x 48,3	2,9 - 2,6	CRXX6048	4,50
2 1/2" x 1"	* 76,1 x 33,7	2,9 - 2,6	CRXX7633	13,55
2 1/2" x 1 1/4"	76,1 x 42,4	2,9 - 2,6	CRXX7642	8,30
2 1/2" x 1 1/2"	76,1 x 48,3	2,9 - 2,6	CRXX7648	6,40
2 1/2" x 2"	76,1 x 60,3	2,9 - 2,9	CRXX7660	5,90
3" x 1 1/4"	* 88,9 x 42,4	3,2 - 2,6	CRXX8942	13,15
3" x 1 1/2"	88,9 x 48,3	3,2 - 2,6	CRXX8948	10,30
3" x 2"	88,9 x 60,3	3,2 - 2,9	CRXX8960	8,35
3" x 2 1/2"	88,9 x 76,1	3,2 - 2,9	CRXX8976	7,70
3 1/2" x 2"	* 101,6 x 60,3	3,6 - 2,9	CRX10160	16,70
3 1/2" x 2 1/2"	* 101,6 x 76,1	3,6 - 2,9	CRX10176	14,10
3 1/2" x 3"	* 101,6 x 88,9	3,6 - 3,2	CRX10189	12,30
	* 108,0 x 60,3	3,6 - 2,9	CRX10860	16,85
	* 108,0 x 76,1	3,6 - 2,9	CRX10876	14,20
	* 108,0 x 88,9	3,6 - 3,2	CRX10889	12,70
4" x 1 1/2"	* 114,3 x 48,3	3,6 - 2,6	CRX11448	18,55
4" x 2"	114,3 x 60,3	3,6 - 2,9	CRX11460	13,60
4" x 2 1/2"	114,3 x 76,1	3,6 - 2,9	CRX11476	12,25
4" x 3"	114,3 x 88,9	3,6 - 3,2	CRX11489	11,70
4" x 3 1/2"	* 114,3 x 101,6	3,6 - 3,6	CR114101	15,55
	* 133,0 x 76,1	4,0 - 2,9	CRX13376	29,70
	* 133,0 x 88,9	4,0 - 3,2	CRX13389	24,75
	* 133,0 x 101,6	4,0 - 3,6	CR133101	26,60
	* 133,0 x 108,0	4,0 - 3,6	CR133108	24,90
	* 133,0 x 114,3	4,0 - 3,6	CR133114	22,00

Ø	Ø EXT. mm.	ESPESSURA mm.	COD.	€
5" x 2"	* 139,7 x 60,3	4,0 - 2,9	CRX13960	35,05
5" x 2 1/2"	139,7 x 76,1	4,0 - 2,9	CRX13976	27,10
5" x 3"	139,7 x 88,9	4,0 - 3,2	CRX13989	22,35
5" x 3 1/2"	* 139,7 x 101,6	4,0 - 3,6	CR139101	29,05
	* 139,7 x 108,0	4,0 - 3,6	CR139108	24,80
5" x 4"	139,7 x 114,3	4,0 - 3,6	CR139114	20,65
	* 159,0 x 88,9	4,5 - 3,2	CRX15989	38,35
	* 159,0 x 108,0	4,5 - 3,6	CR159108	35,35
	* 159,0 x 114,3	4,5 - 3,6	CR159114	34,15
	* 159,0 x 133,0	4,5 - 4,0	CR159133	30,10
	* 159,0 x 139,7	4,5 - 4,0	CR159139	30,10
6" x 2 1/2"	* 168,3 x 76,1	4,5 - 2,9	CRX16876	43,90
6" x 3"	168,3 x 88,9	4,5 - 3,2	CRX16889	35,80
6" x 4"	168,3 x 114,3	4,5 - 3,6	CR168114	28,60
6" x 5"	168,3 x 139,7	4,5 - 4,0	CR168139	26,25
	* 193,7 x 114,3	5,6 - 3,6	CR193114	131,45
	* 193,7 x 133,0	5,6 - 4,0	CR193133	124,90
	* 193,7 x 159,0	5,6 - 4,5	CR193159	105,50
	* 193,7 x 168,3	5,6 - 4,5	CR193168	100,85
8" x 4"	219,1 x 114,3	6,3 - 3,6	CR219114	65,05
	* 219,1 x 133,0	6,3 - 4,0	CR219133	75,55
8" x 5"	219,1 x 139,7	6,3 - 4,0	CR219139	59,75
	* 219,1 x 159,0	6,3 - 4,5	CR219159	69,40
8" x 6"	219,1 x 168,3	6,3 - 4,5	CR219168	49,40
10" x 5"	273,0 x 139,7	6,3 - 4,0	CR273139	113,75
10" x 6"	273,0 x 168,3	6,3 - 4,5	CR273168	96,00
10" x 8"	273,0 x 219,1	6,3 - 6,3	CR273219	76,80
12" x 6"	323,9 x 168,3	7,1 - 4,5	CR323168	176,65
12" x 8"	323,9 x 219,1	7,1 - 6,3	CR323219	151,35
12" x 10"	323,9 x 273,0	7,1 - 6,3	CR323273	141,55
14" x 8"	355,6 x 219,1	8,0 - 6,3	CR355219	414,00
14" x 10"	355,6 x 273,0	8,0 - 6,3	CR355273	386,40
14" x 12"	355,6 x 323,9	8,0 - 7,1	CR355323	358,80
16" x 10"	406,4 x 273,0	8,8 - 6,3	CR406273	546,50
16" x 12"	406,4 x 323,9	8,8 - 7,1	CR406323	538,20
16" x 14"	406,4 x 355,6	8,8 - 8,0	CR406355	524,40

* Não corresponde à Norma EN 10253

ACESSÓRIOS DE AÇO PARA SOLDAR NORMA ASTM

CURVA ASTM A-234 WPB - ASME B 16.9



DIMENSÕES		STD								XS					
		RAIO LONGO						RAIO CURTO		RAIO LONGO				RAIO CURTO	
		90°		45°		180°		90°		90°		45°		90°	
Ø	Ø EXT. mm.	COD.	€	COD.	€	COD.	€	COD.	€	COD.	€	COD.	€	COD.	€
1/2"	21,3	CSTL900M	2,20	CSTL450M	1,40					CXSL900M	3,50	CXSL450M	1,95		
3/4"	26,7	CSTL900T	2,45	CSTL450T	1,60					CXSL900T	3,60	CXSL450T	2,00		
1"	33,4	CSTL9001	3,10	CSTL4501	2,05			CSTS9001	3,45	CXSL9001	4,60	CXSL4501	2,20	CXSS9001	6,25
1 1/4"	42,2	CSTL901C	3,45	CSTL451C	2,30			CSTS901C	5,75	CXSL901C	5,65	CXSL451C	3,40	CXSS901C	7,95
1 1/2"	48,3	CSTL901M	4,25	CSTL451M	2,35	CSTL181M	8,80	CSTS901M	5,80	CXSL901M	6,35	CXSL451M	4,10	CXSS901M	8,35
2"	60,3	CSTL9002	6,80	CSTL4502	3,90	CSTL1802	19,90	CSTS9002	6,80	CXSL9002	9,45	CXSL4502	6,00	CXSS9002	10,80
2 1/2"	73,0	CSTL902M	12,80	CSTL452M	7,35	CSTL182M	35,15	CSTS902M	12,90	CXSL902M	17,25	CXSL452M	11,15	CXSS902M	19,80
3"	88,9	CSTL9003	19,45	CSTL4503	11,25	CSTL1803	51,40	CSTS9003	20,65	CXSL9003	25,05	CXSL4503	16,10	CXSS9003	28,80
3 1/2"	101,6	CSTL903M	27,30	CSTL453M	16,75					CXSL903M	42,85	CXSL453M	28,10		
4"	114,3	CSTL9004	33,95	CSTL4504	20,00	CSTL1804	82,85	CSTS9004	34,50	CXSL9004	49,10	CXSL4504	30,55	CXSS9004	49,35
5"	141,3	CSTL9005	58,30	CSTL4505	34,45	CSTL1805	140,35	CSTS9005	59,50	CXSL9005	88,15	CXSL4505	55,45	CXSS9005	94,45
6"	168,3	CSTL9006	90,05	CSTL4506	58,35	CSTL1806	243,00	CSTS9006	96,55	CXSL9006	148,70	CXSL4506	96,65	CXSS9006	157,25
8"	219,1	CSTL9008	170,20	CSTL4508	110,35			CSTS9008	182,75	CXSL9008	321,10	CXSL4508	207,80	CXSS9008	284,90
10"	273,0	CSTL9010	308,70	CSTL4510	200,15			CSTS9010	376,95	CXSL9010	474,90	CXSL4510	307,40	CXSS9010	445,55
12"	323,8	CSTL9012	444,65	CSTL4512	288,30			CSTS9012	557,05	CXSL9012	692,95	CXSL4512	446,45	CXSS9012	677,60
14"	355,6	CSTL9014	607,95	CSTL4514	362,25			CSTS9014	696,05	CXSL9014	1.015,95	CXSL4514	646,80	CXSS9014	969,80
16"	406,4	CSTL9016	780,15	CSTL4516	483,00			CSTS9016	910,55	CXSL9016	1.384,30	CXSL4516	879,80	CXSS9016	1.415,10
18"	457,0	CSTL9018	1.070,80	CSTL4518	661,40										
20"	508,0	CSTL9020	1.344,80	CSTL4520	838,30										
24"	610,0	CSTL9024	2.310,10	CSTL4524	1.415,10										



TAMPÃO ASTM A-234 WPB - ASME B 16.9

DIMENSÕES		STD		XS	
Ø	Ø EXT. mm.	COD.	€	COD.	€
1/2"	21,3	CCSTXX0M	3,95	CCXSXX0M	4,25
3/4"	26,7	CCSTXX0T	4,25	CCXSXX0T	4,65
1"	33,4	CCSTXX01	4,75	CCXSXX01	5,75
1 1/4"	42,2	CCSTXX1C	4,85	CCXSXX1C	5,80
1 1/2"	48,3	CCSTXX1M	4,90	CCXSXX1M	5,90
2"	60,3	CCSTXX02	5,05	CCXSXX02	6,00
2 1/2"	73,0	CCSTXX2M	5,65	CCXSXX2M	7,05
3"	88,9	CCSTXX03	8,05	CCXSXX03	11,00
3 1/2"	101,6	CCSTXX3M	10,95	CCXSXX3M	14,25
4"	114,3	CCSTXX04	12,55	CCXSXX04	16,45
5"	141,3	CCSTXX05	19,30	CCXSXX05	27,90
6"	168,3	CCSTXX06	33,05	CCXSXX06	42,00
8"	219,1	CCSTXX08	60,85	CCXSXX08	69,00
10"	273,0	CCSTXX10	108,60	CCXSXX10	123,30
12"	323,8	CCSTXX12	144,65	CCXSXX12	200,35
14"	355,6	CCSTXX14	174,00	CCXSXX14	262,25
16"	406,4	CCSTXX16	213,95	CCXSXX16	384,55
18"	457,0	CCSTXX18	338,40	CCXSXX18	541,40
20"	508,0	CCSTXX20	406,10	CCXSXX20	689,10
24"	610,0	CCSTXX24	584,50	CCXSXX24	879,80



TÊ ASTM A-234 WPB - ASME B 16.9

STD		XS	
COD.	€	COD.	€
CTXXXX21	4,85	CTXSXX0M	6,10
CTXXXX27	5,25	CTXSXX0T	6,60
CTXXXX33	7,70	CTXSXX01	9,55
CTXXXX42	8,90	CTXSXX1C	11,40
CTXXXX48	11,25	CTXSXX1M	12,15
CTXXXX60	17,00	CTXSXX02	23,25
CTXXXX76	26,25	CTXSXX2M	27,85
CTXXXX89	38,60	CTXSXX03	42,05
CTXXX101	53,00	CTXSXX3M	59,30
CTXXX114	66,45	CTXSXX04	80,20
CTXXX140	107,00	CTXSXX05	126,25
CTXXX168	148,70	CTXSXX06	215,35
CTXXX219	275,00	CTXSXX08	370,00
CTXXX273	505,60	CTXSXX10	677,95
CTXXX324	715,00	CTXSXX12	1.024,10
CTXXX355	1.234,40	CTXSXX14	1.261,25
CTXXX406	1.391,40	CTXSXX16	2.018,00
CTXXX457	2.313,40		
CTXXX508	3.010,95		
CTXXX610	3.791,50		

TÊ DE REDUÇÃO E REDUÇÕES CONCÊNTRICAS E EXCÊNTRICAS ASTM A-234 WPB - ASME B 16.9



DIMENSÕES		TÊ DE REDUÇÃO		REDUÇÃO CONCÊNTRICA				REDUÇÃO EXCÊNTRICA	
		STD		STD		XS		STD	
Ø	Ø EXT. mm.	COD.	€	COD.	€	COD.	€	COD.	€
3/4" x 1/2"	26,7 x 21,3	CTST0T0M	3,70	CRST0T0M	2,90	CRXS0T0M	3,90	CREX0T0M	3,10
1" x 1/2"	33,4 x 21,3	CTST010M	6,10	CRST010M	3,20	CRXS010M	5,40	CREX010M	4,05
1" x 3/4"	33,4 x 26,7	CTST010T	5,20	CRST010T	3,10	CRXS010T	4,90	CREX010T	3,95
1 1/4" x 1/2"	42,2 x 21,3	CTST1C0M	8,10	CRST1C0M	3,60	CRXS1C0M	5,65	CREX1C0M	11,65
1 1/4" x 3/4"	42,2 x 26,7	CTST1C0T	7,80	CRST1C0T	3,35	CRXS1C0T	5,10	CREX1C0T	6,55
1 1/4" x 1"	42,2 x 33,4	CTST1C01	7,65	CRST1C01	3,15	CRXS1C01	4,65	CREX1C01	4,05
1 1/2" x 1/2"	48,3 x 21,3	CTST1M0M	11,85	CRST1M0M	4,25	CRXS1M0M	5,45	CREX1M0M	13,70
1 1/2" x 3/4"	48,3 x 26,7	CTST1M0T	11,55	CRST1M0T	3,90	CRXS1M0T	4,85	CREX1M0T	13,55
1 1/2" x 1"	48,3 x 33,4	CTST1M01	11,10	CRST1M01	3,60	CRXS1M01	4,60	CREX1M01	4,50
1 1/2" x 1 1/4"	48,3 x 42,2	CTST1M1C	10,80	CRST1M1C	3,45	CRXS1M1C	4,30	CREX1M1C	3,50
2" x 1/2"	60,3 x 21,3			CRST020M	10,85				
2" x 3/4"	60,3 x 26,7			CRST020T	5,45			CREX020T	13,15
2" x 1"	60,3 x 33,4	CTST0201	21,85	CRST0201	4,90	CRXS0201	6,50	CREX0201	7,55
2" x 1 1/4"	60,3 x 42,2	CTST021C	20,95	CRST021C	4,50	CRXS021C	6,20	CREX021C	5,65
2" x 1 1/2"	60,3 x 48,3	CTST021M	20,45	CRST021M	4,30	CRXS021M	5,75	CREX021M	5,40
2 1/2" x 1"	73,0 x 33,4	CTST2M01	26,05	CRST2M01	9,20			CREX2M01	29,55
2 1/2" x 1 1/4"	73,0 x 42,2	CTST2M1C	25,65	CRST2M1C	8,10	CRXS2M1C	11,55	CREX2M1C	21,75
2 1/2" x 1 1/2"	73,0 x 48,3	CTST2M1M	25,45	CRST2M1M	7,65	CRXS2M1M	10,70	CREX2M1M	9,45
2 1/2" x 2"	73,0 x 60,3	CTST2M02	25,35	CRST2M02	7,05	CRXS2M02	9,95	CREX2M02	8,55
3" x 1"	88,9 x 33,4	CTST0301	39,25	CRST0301	17,50				
3" x 1 1/4"	88,9 x 42,2	CTST031C	38,45	CRST031C	10,60	CRXS031C	14,25	CREX031C	24,10
3" x 1 1/2"	88,9 x 48,3	CTST031M	38,20	CRST031M	9,85	CRXS031M	13,80	CREX031M	16,60
3" x 2"	88,9 x 60,3	CTST0302	37,85	CRST0302	9,15	CRXS0302	12,40	CREX0302	11,55
3" x 2 1/2"	88,9 x 73,0	CTST032M	37,70	CRST032M	8,55	CRXS032M	12,10	CREX032M	10,70
4" x 1 1/4"	114,3 x 42,2			CRST041C	21,35				
4" x 1 1/2"	114,3 x 48,3	CTST041M	70,95	CRST041M	18,45	CRXS041M	27,50	CREX041M	25,90
4" x 2"	114,3 x 60,3	CTST0402	67,85	CRST0402	17,15	CRXS0402	24,50	CREX0402	21,35
4" x 2 1/2"	114,3 x 73,0	CTST042M	66,15	CRST042M	15,30	CRXS042M	21,90	CREX042M	19,25
4" x 3"	114,3 x 88,9	CTST0403	63,55	CRST0403	14,15	CRXS0403	21,05	CREX0403	17,15
5" x 2"	141,3 x 60,3	CTST0502	116,45	CRST0502	30,65			CREX0502	57,75
5" x 2 1/2"	141,3 x 73,0	CTST052M	115,30	CRST052M	27,85	CRXS052M	39,90	CREX052M	54,50
5" x 3"	141,3 x 88,9	CTST0503	113,55	CRST0503	25,65	CRXS0503	40,75	CREX0503	31,95
5" x 4"	141,3 x 114,3	CTST0504	112,70	CRST0504	23,25	CRXS0504	36,85	CREX0504	29,05
6" x 2"	168,3 x 60,3	CTST0602	163,80	CRST0602	50,05				
6" x 2 1/2"	168,3 x 73,0	CTST062M	160,00	CRST062M	47,05	CRXS062M	62,85	CREX062M	73,85
6" x 3"	168,3 x 88,9	CTST0603	158,85	CRST0603	41,90	CRXS0603	58,40	CREX0603	52,55
6" x 4"	168,3 x 114,3	CTST0604	157,05	CRST0604	37,65	CRXS0604	55,65	CREX0604	47,05
6" x 5"	168,3 x 141,3	CTST0605	153,80	CRST0605	35,55	CRXS0605	53,05	CREX0605	45,30
8" x 3"	219,1 x 88,9	CTST0803	291,60	CRST0803	67,60				
8" x 4"	219,1 x 114,3	CTST0804	288,40	CRST0804	60,05	CRXS0804	100,10	CREX0804	79,05
8" x 5"	219,1 x 141,3	CTST0805	286,30	CRST0805	57,45	CRXS0805	94,25	CREX0805	71,80
8" x 6"	219,1 x 168,3	CTST0806	284,35	CRST0806	57,20	CRXS0806	88,15	CREX0806	69,35
10" x 4"	273,0 x 114,3	CTST1004	517,55	CRST1004	135,35			CREX1004	280,75
10" x 5"	273,0 x 141,3	CTST1005	516,25	CRST1005	117,65	CRXS1005	178,40	CREX1005	226,15
10" x 6"	273,0 x 168,3	CTST1006	511,25	CRST1006	108,75	CRXS1006	145,95	CREX1006	203,05
10" x 8"	273,0 x 219,1	CTST1008	507,95	CRST1008	102,00	CRXS1008	140,20	CREX1008	127,40
12" x 6"	323,8 x 168,3	CTST1206	846,00	CRST1206	184,60	CRXS1206	240,35	CREX1206	353,80
12" x 8"	323,8 x 219,1	CTST1208	757,55	CRST1208	156,65	CRXS1208	223,85	CREX1208	195,65
12" x 10"	323,8 x 273,0	CTST1210	753,50	CRST1210	138,80	CRXS1210	216,15	CREX1210	171,05
14" x 8"	355,6 x 219,1			CRST1408	324,90			CREX1408	622,95
14" x 10"	355,6 x 273,0	CTST1410	1.461,25	CRST1410	270,70	CRXS1410	457,85	CREX1410	381,45
14" x 12"	355,6 x 323,8	CTST1412	1.453,55	CRST1412	250,15	CRXS1412	414,45	CREX1412	338,40
16" x 8"	406,4 x 219,1			CRST1608	393,75			CREX1608	907,50
16" x 10"	406,4 x 273,0	CTST1610	1.994,95	CRST1610	365,20	CRXS1610	573,05	CREX1610	535,25
16" x 12"	406,4 x 323,8	CTST1612	1.987,25	CRST1612	347,35	CRXS1612	554,00	CREX1612	479,90
16" x 14"	406,4 x 355,6	CTST1614	1.975,00	CRST1614	338,40	CRXS1614	548,20	CREX1614	436,90
18" x 16"	457,0 x 406,4	CTST1816	2.573,30	CRST1816	765,95				
20" x 16"	508,0 x 406,4	CTST2016	3.363,90	CRST2016	1.322,80				
20" x 18"	508,0 x 457,0	CTST2018	3.330,05	CRST2018	1.228,35				
24" x 18"	610,0 x 457,0	CTST2418	4.606,65	CRST2418	1.535,00				
24" x 20"	610,0 x 508,0	CTST2420	4.592,80	CRST2420	1.376,60				

ACESSÓRIOS DE AÇO PARA SOLDAR.

**CURVA ASTM A-420 WPL6
ASME B 16.9**

DIMENSÕES		STD - RAIOS LONGO	
Ø	Ø EXT.	COD.	€
1/2"	21,3	CL90460M	5,33
3/4"	26,9	CL90460T	5,67
1"	33,7	CL904601	6,01
1 1/4"	42,4	CL90461C	6,83
1 1/2"	48,3	CL90461M	8,06
2"	60,3	CL904602	10,45
2 1/2"	73,0	CL90462M	16,87
3"	88,9	CL904603	24,73
4"	114,3	CL904604	43,51
5"	141,3	CL904605	75,00
6"	168,3	CL904606	110,05
8"	219,1	CL904608	219,82
10"	273,0	CL904610	402,82

**TAMPÃO ASTM A-420 WPL6
ASME B 16.9**

DIMENSÕES		STD	
Ø	Ø EXT.	COD.	€
2"	60,3	CCX40602	9,15
2 1/2"	73,0	CCX4062M	11,41
3"	88,9	CCX40603	13,05
4"	114,3	CCX40604	21,59
5"	141,3	CCX40605	30,26
6"	168,3	CCX40606	43,17
8"	219,1	CCX40608	72,89
10"	273,0	CCX40610	129,79

**TÊ ASTM A-420 WPL6
ASME B 16.9**

DIMENSÕES		STD	
Ø	Ø EXT.	COD.	€
1/2"	21,3	CTX4060M	10,52
3/4"	26,9	CTX4060T	10,59
1"	33,7	CTX40601	12,36
1 1/4"	42,4	CTX4061C	12,98
1 1/2"	48,3	CTX4061M	16,39
2"	60,3	CTX40602	21,52
2 1/2"	73,0	CTX4062M	37,02
3"	88,9	CTX40603	47,68
4"	114,3	CTX40604	74,05
5"	141,3	CTX40605	118,59
6"	168,3	CTX40606	161,69
8"	219,1	CTX40608	273,38
10"	273,0	CTX40610	500,51

**REDUÇÃO CONCÊNTRICA ASTM A-420 WPL6
ASME B 16.9**

DIMENSÕES		STD	
Ø	Ø EXT.	COD.	€
1" x 3/4"	33,4 x 26,7	CR46010T	15,78
1 1/4" x 1"	42,2 x 33,4	CR461C01	17,35
1 1/2" x 1 1/4"	48,3 x 42,2	CR461M1C	19,47
2" x 1"	60,3 x 33,4	CR460201	13,80
2" x 1 1/2"	60,3 x 48,3	CR46021M	11,41
2 1/2" x 2"	73,0 x 60,3	CR462M02	24,59
3" x 2"	88,9 x 60,3	CR460302	17,35
3" x 2 1/2"	88,9 x 73,0	CR46032M	16,80
4" x 2"	114,3 x 60,3	CR460402	26,03
4" x 3"	114,3 x 88,9	CR460403	22,41
5" x 3"	141,3 x 88,9	CR460503	41,40
5" x 4"	141,3 x 114,3	CR460504	37,02
6" x 4"	168,3 x 114,3	CR460604	54,37
6" x 5"	168,3 x 141,3	CR460605	49,66
8" x 6"	219,1 x 168,3	CR460806	78,76
10" x 6"	273,0 x 168,3	CR461006	140,92
12" x 10"	323,8 x 273,0	CR461210	184,10
14" x 10"	355,6 x 273,0	CR461410	614,24
14" x 12"	355,6 x 323,8	CR461412	555,43
16" x 10"	406,4 x 273,0	CR461610	1198,02
16" x 12"	406,4 x 323,8	CR461612	936,60
16" x 14"	406,4 x 355,6	CR461614	875,67

FLANGES DE AÇO CARBONO



FLANGE CONFORME NORMA ASTM - ANSI B 16.5 (A105)

DIMENSÕES			WELDING NECK 150 Lbs.		WELDING NECK 300 Lbs.		SLIP - ON 150 Lbs.		SLIP - ON 300 Lbs.	
DN	Ø	mm.	COD.	€	COD.	€	COD.	€	COD.	€
15	1/2"	21,3	FN150015	6,25	FN300015	9,95	FO150015	4,05	FO300015	7,15
20	3/4"	26,9	FN150020	8,80	FN300020	16,25	FO150020	7,15	FO300020	11,30
25	1"	33,7	FN150025	13,80	FN300025	21,35	FO150025	8,20	FO300025	14,35
32	1 1/4"	42,4	FN150032	17,80	FN300032	27,55	FO150032	10,65	FO300032	18,50
40	1 1/2"	48,3	FN150040	21,40	FN300040	40,15	FO150040	13,65	FO300040	26,70
50	2"	60,3	FN150050	32,05	FN300050	45,25	FO150050	21,35	FO300050	34,95
65	2 1/2"	76,2	FN150065	52,25	FN300065	67,80	FO150065	34,95	FO300065	45,25
80	3"	88,9	FN150080	61,75	FN300080	92,90	FO150080	39,80	FO300080	62,65
100	4"	114,3	FN150100	89,05	FN300100	149,50	FO150100	54,40	FO300100	103,75
125	5"	139,7	FN150125	109,25	FN300125	200,95	FO150125	61,20	FO300125	128,45
150	6"	168,3	FN150150	130,65	FN300150	253,70	FO150150	72,90	FO300150	166,45
200	8"	219,1	FN150200	217,30	FN300200	389,35	FO150200	122,40	FO300200	254,80
250	10"	273,0	FN150250	296,90	FN300250	556,40	FO150250	179,75	FO300250	381,20
300	12"	323,9	FN150300	463,10	FN300300	803,75	FO150300	272,00	FO300300	513,65
350	14"	355,6	FN150350	640,50	FN300350	1.105,25	FO150350	369,90	FO300350	719,35
400	16"	406,4	FN150400	802,60	FN300400	1.419,30	FO150400	472,60	FO300400	996,80
450	18"	457,0	FN150450	940,80	FN300450	1.682,95	FO150450	513,85	FO300450	1.263,95
500	20"	508,0	FN150500	1.174,30	FN300500	2.147,75	FO150500	657,70	FO300500	1.366,75
600	24"	610,0	FN150600	1.507,20	FN300600	2.888,80	FO150600	953,85	FO300600	2.065,60

DIMENSÕES			BLIND 150 Lbs.		BLIND 300 Lbs.		SOCKET WELDING 150 Lbs.		WELDING NECK XS 150 Lbs.	
DN	Ø	mm.	COD.	€	COD.	€	COD.	€	COD.	€
15	1/2"	21,3	FB150015	3,35	FB300015	5,85	FW150015	5,00	FNX15015	6,80
20	3/4"	26,9	FB150020	5,85	FB300020	10,05	FW150020	8,80	FNX15020	9,70
25	1"	33,7	FB150025	7,50	FB300025	12,60	FW150025	11,30	FNX15025	15,35
32	1 1/4"	42,4	FB150032	10,90	FB300032	16,70	FW150032	15,05	FNX15032	18,30
40	1 1/2"	48,3	FB150040	13,35	FB300040	24,25	FW150040	18,75	FNX15040	22,00
50	2"	60,3	FB150050	20,55	FB300050	28,50	FW150050	28,90	FNX15050	33,00
65	2 1/2"	76,2	FB150065	32,40	FB300065	42,70			FNX15065	53,25
80	3"	88,9	FB150080	39,50	FB300080	58,65			FNX15080	63,45
100	4"	114,3	FB150100	56,25	FB300100	98,75			FNX15100	89,80
125	5"	139,7	FB150125	71,25	FB300125	129,80			FNX15125	109,65
150	6"	168,3	FB150150	93,40	FB300150	180,85			FNX15150	132,35
200	8"	219,1	FB150200	166,30	FB300200	294,70			FNX15200	218,70
250	10"	273,0	FB150250	237,50	FB300250	477,20				
300	12"	323,9	FB150300	356,20	FB300300	686,55				
350	14"	355,6	FB150350	493,95	FB300350	887,60				
400	16"	406,4	FB150400	661,45	FB300400	1.172,25				
450	18"	457,0	FB150450	812,25	FB300450	1.490,45				
500	20"	508,0	FB150500	1.038,35	FB300500	1.867,25				
600	24"	610,0	FB150600	1.285,65	FB300600	2.838,55				

FLANGE PLANA CONFORME NORMA EN 1092-1 01

DIMENSÕES			FLANGE PLANA CONFORME NORMA EN 1092-1 01							
			PN 6		PN 10					
DN	"	mm.	COD.	€	COD.	€	COD.	€		
15	1/2"	21,3	FC010015	2,55			FC014015	4,20		
20	3/4"	26,9	FC010020	3,85			FC014020	5,65		
25	1"	33,7	FC010025	4,60			FC014025	6,75		
32	1 1/4"	42,4	FC010032	7,35			FC014032	9,30		
40	1 1/2"	48,3	FC010040	8,45			FC014040	10,65		
50	2"	60,3	FC010050	8,60			FC016050	13,15		
65	2 1/2"	76,1					F2576065	16,55		
	2 1/2"	76,1	FC010065	10,50			FC016065	16,55		
80	3"	88,9	FC010080	17,25	F2576080	20,85	FC016080	20,95		
90	3 1/2"	101,6			F2576101	31,15				
100	4"	108,0			F2576108	23,10				
	4"	114,3	FC010100	20,15			FC016100	22,20		
125	5"	133,0			F2576133	33,55				
	5"	139,7	FC010125	26,75			FC016125	28,95		
150	6"	159,0			F2576159	34,80				
	6"	168,3	FC010150	30,30			FC016150	36,75		
175	7"	193,7			F2576175	51,90				
200	8"	219,1	FC010200	39,95			FC011200	51,90		
250	10"	273,0	FC010250	57,90			FC011250	63,00		
300	12"	323,9	FC010300	75,90			FC011300	73,05		
350	14"	355,6	FC010350	97,40			FC011350	117,70		
400	16"	406,4	FC010400	115,00			FC011400	159,45		
450	18"	457,0	FC010450	133,80			FC011450	214,45		
500	20"	508,0	FC010500	153,75			FC011500	234,80		
600	24"	610,0					FC011600	314,00		
	24"	610,0					F2576600	281,20		
700	28"	711,0					F2576700	356,75		
800	32"	813,0					F2576800	497,70		
900	36"	914,0					F2576900	598,75		
1000	40"	1.016,0					F2576999	738,30		

Flanges não normalizadas
 4 Furos
 Conforme DIN 2576
 Conforme DIN 2502

FLANGE PLANA CONFORME NORMA EN 1092-1 01

PN 16		PN 25		PN 40	
COD.	€	COD.	€	COD.	€
		FC014015	4,20	FC014015	4,20
		FC014020	5,65	FC014020	5,65
		FC014025	6,75	FC014025	6,75
		FC014032	9,30	FC014032	9,30
		FC014040	10,65	FC014040	10,65
		FC016050	13,15	FC016050	13,15
		F2576065	16,55		
		FC016065	16,55	FC014065	18,75
		FC016080	20,95	FC014080	25,35
		FC016100	22,20	FC014100	33,60
		FC016125	28,95	FC014125	45,85
		FC016150	36,75	FC014150	58,85
F2502200*	54,50	FC016200	75,70	FC012200	79,20
		FC016250	110,50	FC012250	112,95
F2502300*	92,00	FC016300	147,90	FC012300	160,55
		FC016350	232,05	FC012350	280,70
		FC016400	295,50	FC012400	300,45
F2502450*	305,30	FC016450	379,45		
		FC016500	470,15	FC012500	485,15
		FC016600	521,55		
		F2502600	401,00		
		F2502700	458,90		
		F2502800	576,70		
		F2502900	726,85		
		F2502999	1.046,65		

FLANGE CEGA CONFORME NORMA EN 1092-1 05

DIMENSÕES			FLANGE CEGA CONFORME NORMA EN 1092-1 05			
			PN 6		PN 10	
DN	"	mm.	COD.	€	COD.	€
15	1/2"	21,3	FC050015	4,40	FC054015	4,55
20	3/4"	26,9	FC050020	5,95	FC054020	6,10
25	1"	33,7	FC050025	7,35	FC054025	7,45
32	1 1/4"	42,4	FC050032	10,05	FC054032	10,25
40	1 1/2"	48,3	FC050040	11,75	FC054040	12,00
50	2"	60,3	FC050050	16,10	FC056050	16,25
65	2 1/2"	76,1			F2527065	20,55
	2 1/2"	76,1	FC050065	20,35	FC056065	20,55
80	3"	88,9	FC050080	26,60	FC056080	26,85
100	4"	114,3	FC050100	31,40	FC056100	31,70
125	5"	139,7	FC050125	47,05	FC056125	47,20
150	6"	168,3	FC050150	57,40	FC056150	58,35
200	8"	219,1	FC050200	91,10	FC051200	91,20
250	10"	273,0	FC050250	134,55	FC051250	141,80
300	12"	323,9	FC050300	173,20	FC051300	199,85
350	14"	355,6			FC051350	273,65
400	16"	406,4			FC051400	297,60
450	18"	457,0			FC051450	480,85
500	20"	508,0			FC051500	487,25
600	24"	610,0			FC051600	626,50
	24"	610,0			F5271600	592,10
700	28"	711,0			F5271700	839,60
800	32"	813,0			F5271800	1.230,55
900	36"	914,0			F5271900	1.859,15
1000	40"	1.016,0			F5271999	2.390,90

Flanges não normalizadas

4 Furos

Conforme DIN 2527

FLANGE CEGA CONFORME NORMA EN 1092-1 05

PN 16		PN 25		PN 40			
COD.	€	COD.	€	COD.	€	COD.	€
FC054015	4,55	FC054015	4,55			FC054015	4,55
FC054020	6,10	FC054020	6,10			FC054020	6,10
FC054025	7,45	FC054025	7,45			FC054025	7,45
FC054032	10,25	FC054032	10,25			FC054032	10,25
FC054040	12,00	FC054040	12,00			FC054040	12,00
FC056050	16,25	FC054050	17,80			FC054050	17,80
F2527065	20,55						
FC056065	20,55	FC054065	23,85			FC054065	23,85
FC056080	26,85	FC054080	32,90			FC054080	32,90
FC056100	31,70	FC054100	42,10			FC054100	42,10
FC056125	47,20	FC054125	60,40			FC054125	60,40
FC056150	58,35	FC054150	80,80			FC054150	80,80
FC056200	92,00	FC052200	131,90			FC054200	162,95
FC056250	142,25	FC052250	198,15			FC054250	265,80
FC056300	200,50	FC052300	273,55			FC054300	379,80
FC056350	305,60	FC052350	402,00			FC054350	539,70
FC056400	382,55	FC052400	540,30			FC054400	783,95
FC056450	567,60						
FC056500	614,40	FC052500	831,35	F5274500*	1.036,20	FC054500	1.072,85
FC056600	969,95						
F2527600	909,65						
F2527700	1.072,40						
F2527800	1.470,05						
F2527900	2.099,55						
F2527999	2.817,60						

FLANGE COM COLARINHO CONFORME NORMA EN 1092-1 11

DIMENSÕES			FLANGE COM COLARINHO CONFORME NORMA EN 1092-1 11					
			PN 6		PN 10			
DN	"	mm.	COD.	€	COD.	€	COD.	€
15	1/2"	21,3	F2631015	4,20	F2633015	8,30	FC114015	9,15
20	3/4"	26,9	F2631020	6,35	F2633020	10,10	FC114020	12,05
25	1"	33,7	F2631025	8,00	F2633025	11,55	FC114025	14,30
32	1 1/4"	42,4	F2631032	11,60	F2633032	17,00	FC114032	17,55
40	1 1/2"	48,3	F2631040	12,60	F2633040	18,75	FC114040	21,65
50	2"	60,3	F2631050	14,25	F2633050	25,50	FC116050	22,30
65	2 1/2"	76,1	F2631065	16,00	F2633065	27,95	FC116065	24,40
80	3"	88,9	F2631080	26,05	F2633080	33,60	FC116080	29,45
90	3 1/2"	108,0			F2633108	48,85		
100	4"	114,3	F2631100	31,15	F2633100	42,10	FC116100	36,80
125	5"	133,0			F2633133	66,55		
125	5"	139,7	F2631125	43,10	F2633125	66,55	FC116125	58,20
150	6"	159,0			F2633159	81,90		
150	6"	168,3	F2631150	54,80	F2633150	70,70	FC116150	61,75
200	8"	219,1	F2631200	98,65	F2632200	103,00	FC111200	85,95
250	10"	273,0	F2631250	136,95	F2632250	148,30	FC111250	129,60
300	12"	323,9	F2631300	148,95	F2632300	175,50	FC111300	153,40
350	14"	355,6	F2631350	196,80	F2632350	250,85	FC111350	219,25
400	16"	406,4	F2631400	225,45	F2632400	288,40	FC111400	252,05
450	18"	457,0			F2632450	489,55		
500	20"	508,0	F2631500	362,60	F2632500	441,65	FC111500	426,45
600	24"	609,0						
700	28"	711,0						
800	32"	813,0						
900	36"	914,0						
1000	40"	1.016,0						
			MATERIAL P250GH		MATERIAL P250GH		MATERIAL P245GH	

Flanges não normalizadas

4 Furos

Conforme DIN 2633

Conforme DIN 2635

FLANGE COM COLARINHO CONFORME NORMA EN 1092-1 11

PN 16		PN 16		PN 25		PN 25		PN 40		PN 40	
COD.	€	COD.	€	COD.	€	COD.	€	COD.	€	COD.	€
F2633015	8,30	FC114015	9,15	F2635015	9,50	FC114015	9,15	F2635015	9,50	FC114015	9,15
F2633020	10,10	FC114020	12,05	F2635020	12,85	FC114020	12,05	F2635020	12,85	FC114020	12,05
F2633025	11,55	FC114025	14,30	F2635025	16,40	FC114025	14,30	F2635025	16,40	FC114025	14,30
F2633032	17,00	FC114032	17,55	F2635032	19,95	FC114032	17,55	F2635032	19,95	FC114032	17,55
F2633040	18,75	FC114040	21,65	F2635040	24,80	FC114040	21,65	F2635040	24,80	FC114040	21,65
F2633050	25,50	FC116050	22,30	F2635050	28,40	FC114050	25,45	F2635050	28,40	FC114050	25,45
F2633065	27,95	FC116065	24,40	F2635065	34,05	FC114065	30,60	F2635065	34,05	FC114065	30,60
F2633080	33,60	FC116080	29,45	F2635080	43,25	FC114080	40,85	F2635080	43,25	FC114080	40,85
F2633108	48,85										
F2633100	42,10	FC116100	36,80	F2635100	59,40	FC114100	51,35	F2635100	59,40	FC114100	51,35
F2633133	66,55										
F2633125	66,55	FC116125	58,20	F2635125	82,55	FC114125	80,05	F2635125	82,55	FC114125	80,05
F2633159	81,90										
F2633150	70,70	FC116150	61,75	F2635150	107,45	FC114150	93,80	F2635150	107,45	FC114150	93,80
F2633200	105,55	FC116200	87,60	F2634200	180,75			F2635200	195,95	FC114200	178,55
F2633250	157,30	FC116250	137,45	F2634250	259,35			F2635250	351,95	FC114250	291,70
F2633300	221,85	FC116300	193,80	F2634300	331,70			F2635300	501,10	FC114300	475,10
F2633350	314,60	FC116350	274,95	F2634350	501,95			F2635350	796,60		
F2633400	396,30	FC116400	346,25	F2634400	656,10			F2635400	973,00		
F2633450	591,95			F2634450	820,60			F2635450	1.017,70		
F2633500	773,30	FC116500	470,55	F2634500	1.135,80			F2635500	1.179,80		
F2633600	956,35	FC116600	539,10								
F2633700	976,15										
F2633800	1.280,35										
F2633900	1.546,60										
F2633999	2.053,70										
MATERIAL P250GH		MATERIAL P245GH		MATERIAL P250GH		MATERIAL P245GH		MATERIAL P250GH		MATERIAL P245GH	

DIMENSÕES			FLANGE REGA		FLANGE DIN 2642		FLANGE 2573 ROSC.		FLANGE 2576 ROSC.	
					PN 10 ZINCADA		PN 6 ZINCADA		PN 10/16 ZINCADA	
DN	"	mm.	COD.	€	COD.	€	COD.	€	COD.	€
15	1/2"	21,3					F573O015	4,45	F576O015	7,85
20	3/4"	26,9					F573O020	6,50	F576O020	11,20
25	1"	33,7			F2642025	7,85	F573O025	8,00	F576O025	13,20
32	1 1/4"	42,4			F2642032	10,50	F573O032	12,80	F576O032	19,20
40	1 1/2"	48,3	F576R040	8,95	F2642040	12,10	F573O040	15,05	F576O040	22,05
50	2"	60,3	F576R050	9,40	F2642050	13,80	F573O050	16,55	F576O050	29,35
65	2 1/2"	76,1	F576R065	11,45	F2642065	16,45	F573O065	20,50	F576O065	32,50
80	3"	88,9	F576R080	13,55	F2642080	20,90	F573O080	32,25	F576O080 PN 10	41,15
80	3"	88,9	F576R816	13,55					F576O086 PN 16	41,15
100	4"	114,3	F576R100	13,70	F2642100	23,10	F573O100	37,45	F576O100	43,65
125	5"	139,7	F576R125	16,95	F2642125	28,60	F573O125	49,85	F576O125	59,05
150	6"	168,3	F576R150	23,80	F2642150	35,25	F573O150	38,95	F576O150	71,15
200	8"	219,1	F576R200	31,10	F2642200	46,95				
200	8"	219,1	F576R216	31,10						
250	10"	273,0	F576R250	39,25	F2642250	64,80				
300	12"	323,9	F576R300	43,75	F2642300	87,95				

Con 8 furos PN 16

Con 12 furos PN 16

DIMENSÕES			FLANGE ZINCADA PARA PORTA FLANGES DE PE							
			SÉRIE NORMAL PN 10		SÉRIE LIGEIRA PN 10		SÉRIE NORMAL PN 16		SÉRIE LIGEIRA PN 16	
DN	PE Ø EXT (mm)	PVC Ø EXT (mm)	COD.	€	COD.	€	COD.	€	COD.	€
15	20		FPE10015	5,15			FPE10015	5,15		
20	25		FPE10020	7,10			FPE10020	7,10		
25	32		FPE10025	8,30			FPE10025	8,30		
32	40		FPE10032	11,20			FPE10032	11,20		
40	50		FPE10040	14,80	FPR10040	8,55	FPE10040	14,80	FPR10040	8,55
50		50								
50	63	63	FPE10050	15,85	FPR10050	11,70	FPE10050	15,85	FPR10050	11,70
65		63								
65	75	75	FPE10065	20,50	FPR10065	14,45	FPE10065	20,50	FPR10065	14,45
80	90	90	FPE10080	22,35	FPR10080	14,90	FPE10080	22,35	FPR10080	14,90
100	110	110	FPE10100	27,40	FPR10100	20,15	FPE10100	27,40	FPR10100	20,15
100	125		FPE10101	23,70	FPR10101	18,85	FPE10101	23,70	FPR10101	18,85
125	125	125	FPE10125	39,55	FPR10125	28,35	FPE10125	39,55	FPR10125	28,35
125	140	140	FPE10126	33,15	FPR10126	23,95	FPE10126	33,15	FPR10126	23,95
150	160	160	FPE10150	43,40	FPR10150	31,25	FPE10150	43,40	FPR10150	31,25
150	180		FPE10151	39,80	FPR10151	28,75	FPE10151	39,80	FPR10151	28,75
200	200	200	FPE10200	58,25	FPR10200	41,80	FPE16200	59,85	FPR16200	42,35
200	225						FPE16201	54,90	FPR16201	40,65
250	250	250	FPE10250	75,30	FPR10250	64,35	FPE16250	81,45	FPR16250	70,00
300	315	315	FPE10300	89,10	FPR10300	82,15	FPE16300	109,80	FPR16300	93,95
350	355		FPE10350	130,30	FPR10350	121,70	FPE16350	171,80	FPR16350	135,80
400	400		FPE10400	174,10	FPR10400	151,95	FPE16400	192,85	FPR16400	157,50
450	450				FPR10450	165,55			FPR16450	173,85
500	500				FPR10500	176,45			FPR16500	207,35
600	560				FPR10600	253,70				
600	630				FPR10601	221,95				
700	710				FPR10700	269,40				
800	800				FPR10800	398,40				

FLANGE COLARINHO ROSCADA DIN 2566					FLANGE COLARINHO ROSCADA EN 1092-1 TIPO 13							
PN 16 NEGRA		PN 16 GALVA		PN 6 NEGRA		PN 16 NEGRA		PN 16 GALVA		PN 40 NEGRA		
COD.	€	COD.	€	COD.	€	COD.	€	COD.	€	COD.	€	
F5660015	6,50	F566G015	7,70	FC130015	3,80	FC134015	7,65			FC134015	7,65	
F5660020	9,70	F566G020	11,45	FC130020	5,85	FC134020	10,35			FC134020	10,35	
F5660025	12,25	F566G025	13,80	FC130025	7,30	FC134025	12,45			FC134025	12,45	
F5660032	17,00	F566G032	20,15	FC130032	10,35	FC134032	18,05			FC134032	18,05	
F5660040	19,00	F566G040	22,35	FC130040	12,00	FC134040	20,50			FC134040	20,50	
F5660050	25,85	F566G050	30,55	FC130050	13,40	FC136050	23,80	F566G050	30,55			
F5660065	30,55	F566G065	36,75	FC130065	18,30	FC136065	29,65	F566G065	36,75			
F5660080	39,60	F566G080	47,50	FC130080	27,40	FC136080	37,60	F566G080	47,50			
F5660100	42,90	F566G100	51,65			FC136100	43,60	F566G100	51,65			
F5660125	62,90	F566G125	70,85			FC136125	60,45	F566G125	70,85			
F5660150	81,60	F566G150	91,45			FC136150	72,10	F566G150	91,45			

FLANGE ZINCADA PARA PORTAFLANGES DE PVC				
PN 10		PN 16		
COD.	€	COD.	€	
FPVC0050	11,20	FPVC0050	11,20	
FPR10050	11,70	FPR10050	11,70	
FPVC0063	13,55	FPVC0063	13,55	
FPVC0075	13,55	FPVC0075	13,55	
FPVC0090	15,40	FPVC0090	15,40	
FPVC0110	16,40	FPVC0110	16,40	
FPVC0125	20,10	FPVC0125	20,10	
FPVC0140	20,10	FPVC0140	20,10	
FPVC0160	24,25	FPVC0160	24,25	
FPVC0200	36,85	FPVC6200	36,85	
FPVC0250	44,20	FPVC6250	44,20	
FPVC0315	51,30	FPVC6315	51,30	



JUNTA DE BORRACHA



Tipo 1

Tipo 2

Conforme Norma EN 1514-1 (Tipo 1) e DIN 2690 (Tipo 2).

Juntas de 3mm de espessura.

Mantém as suas características:

SBR: entre -10° C e 100° C.

NBR: entre -10° C e 80° C.

■ PN 10
 ■ PN 10/16
 ■ PN 16

DN	TIPO 1		TIPO 1 SBR	TIPO 1 NBR		TIPO 2 SBR		
	Nº ORIFÍCIOS			COD.	€	COD.	€	COD.
25	4	10	JBG10025	0,52	JBG1N025	0,78	JBG20025	0,28
32	4	10	JBG10032	0,62	JBG1N032	1,00	JBG20032	0,34
40	4	10	JBG10040	0,77	JBG1N040	1,20	JBG20040	0,36
50	4	10	JBG10050	0,89	JBG1N050	1,50	JBG20050	0,48
65	8	10	JBG10065	1,10	JBG1N065	1,60	JBG20065	0,60
80	8	10	JBG10080	1,20	JBG1N080	1,85	JBG20080	0,67
80		10					JBG20086	0,67
100	8	10	JBG10100	1,30	JBG1N100	2,15	JBG20100	0,73
125	8	10	JBG10125	1,60	JBG1N125	2,40	JBG20125	1,00
150	8	10	JBG10150	2,05	JBG1N150	3,35	JBG20150	1,15
175	8	10	JBG10175	2,45			JBG20175	1,30
200	8	10	JBG10200	2,65	JBG1N200	4,25	JBG20200	1,50
200	12	10	JBG10216	2,65			JBG20206	1,50
250	12	10	JBG10250	3,55			JBG20250	2,00
250	12	10	JBG10256	3,55			JBG20256	2,00
300	12	10	JBG10300	4,55			JBG20300	2,95
300	12	10	JBG10306	4,55			JBG20306	2,95
350	16	5	JBG10350	6,00			JBG20350	4,70
350	16	5	JBG10356	6,00			JBG20356	4,70
400	16	5	JBG10400	7,05			JBG20400	5,10
400	16	5	JBG10406	7,05			JBG20406	5,10
450	20	5	JBG10450	8,40			JBG20450	6,10
450	20	5	JBG10456	8,40			JBG20456	6,10
500	20	5	JBG10500	12,40			JBG20500	7,35
500	20	5	JBG10506	12,40			JBG20506	7,35

JUNTA CARTÃO COMPRIMIDO



Fabricadas com fibras orgânicas e fibras minerais. SEM AMIANTO.

Espessura 1,5 mm.

Temperatura máxima de utilização 150° C.

Pressão máxima 35 kg./cm².

Aplicações: água, ar, óleos e gorduras, dissolventes.

JUNTAS PARA FLANGES SEM ORIFÍCIOS DIN 2690					
DN	Ø EXT.	Ø INT.		COD.	€
15	50	20	25	JBKSA015	0,24
20	60	25	25	JBKSA020	0,24
25	70	30	25	JBKSA025	0,30
32	82	40	25	JBKSA032	0,33
40	92	50	25	JBKSA040	0,44
50	107	60	25	JBKSA050	0,50
65	127	77	25	JBKSA065	0,69
80	142	90	25	JBKSA080	0,78
100	162	114	25	JBKSA100	1,00
125	192	140	25	JBKSA125	1,25
150	218	168	25	JBKSA150	1,70
200	273	220	25	JBKSA200	2,35
250	328	273	10	JBKSA250	3,40
300	378	325	10	JBKSA300	4,75
350	438	368	10	JBKSA350	7,30
400	490	420	5	JBKSA400	8,75
500	595	520	5	JBKSA500	13,95
600	680	620	1	JBKSA600	27,00

JUNTA SINTÉTICA



O seu DESENHO EXCLUSIVO permite realizar um alinhamento exacto em todos os modelos de Flanges.

Fabricadas em Polietileno.

Temperatura máxima de utilização 40° C. Pressão máxima 16 kgs./cm².

Resistente a ácidos diluídos, alcalinos, soluções salinas, água, álcool, éteres, óleos. São impermeáveis, imputrescíveis e anticorrosivos.

DN	Ø	COD.	€
40	1 1/2"	JBP00040	2,20
50	2"	JBP00050	2,25
65	2 1/2"	JBP00065	2,45
80	3"	JBP00080	2,85
100	4"	JBP00100	3,00
125	5"	JBP00125	3,30
150	6"	JBP00150	3,50
200	8"	JBP00200	5,35
250	10"	JBP00250	12,10
300	12"	JBP00300	19,00
400	16"	JBP00400	30,40
500	20"	JBP00500	54,35

PARAFUSO HEXAGONAL DIN 931 - 8.8 - Zincado

NEW

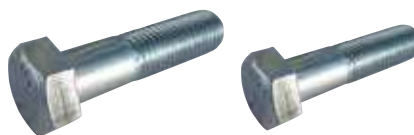

MEDIDA	COMPRIMENTO		COD.	€ 100 UNID.
M8	60	200	T8310860 *	22,40
M10	50	100	T8311050	33,60
M10	60	100	T8311060 *	37,80
M10	70	100	T8311070	43,40
M10	80	100	T8311080	49,00
M10	90	100	T8311090	53,20
M10	100	50	T8311010 *	58,80
M10	120	50	T8311012 *	70,00
M12	40	100	T8311240 *	40,60
M12	50	100	T8311250	47,60
M12	55	100	T8311255 *	51,80
M12	60	100	T8311260 *	54,60
M12	70	50	T8311270	61,60
M12	80	50	T8311280	68,60
M12	90	50	T8311290 *	75,60
M12	100	50	T8311210 *	82,60
M12	110	50	T8311211 *	89,60
M12	120	50	T8311212 *	95,20
M12	140	50	T8311214	109,20
M14	50	50	T8311450 *	67,20
M14	55	50	T8311455 *	72,80
M14	60	50	T8311460 *	77,00
M14	70	50	T8311470 *	86,80
M14	80	50	T8311480 *	95,20
M14	90	50	T8311490 *	103,60
M14	100	50	T8311410 *	113,40
M14	120	50	T8311412 *	134,40
M14	130	50	T8311413 *	140,00
M14	140	50	T8311414 *	154,00
M16	50	50	T8311650	88,20
M16	55	50	T8311655 *	93,80
M16	60	50	T8311660	100,80
M16	65	50	T8311665	107,80
M16	70	50	T8311670	113,40
M16	75	50	T8311675 *	120,40
M16	80	25	T8311680	127,40
M16	90	25	T8311690	140,00
M16	100	25	T8311610	154,00
M16	110	25	T8311611	168,00
M16	120	25	T8311612	175,00
M16	130	25	T8311613	189,00
M16	140	25	T8311614	203,00
M16	150	25	T8311615	217,00
M16	160	25	T8311616	238,00
M16	180	25	T8311618	266,00
M16	200	25	T8311620 *	308,00
M18	60	25	T8311860	131,60
M18	70	25	T8311870	147,00
M18	80	25	T8311880	161,00
M18	90	25	T8311890	182,00
M18	100	25	T8311810 *	196,00
M18	110	25	T8311811 *	210,00
M18	120	25	T8311812	231,00
M18	130	25	T8311813	245,00
M18	140	25	T8311814 *	259,00
M18	150	25	T8311815 *	273,00
M18	160	25	T8311816 *	301,00
M18	180	25	T8311818	336,00
M18	200	20	T8311820	399,00

MEDIDA	COMPRIMENTO		COD.	€ 100 UNID.
M20	60	25	T8312060	161,00
M20	70	25	T8312070	189,00
M20	80	25	T8312080	210,00
M20	90	25	T8312090	252,00
M20	100	25	T8312010	273,00
M20	110	25	T8312011	294,00
M20	120	25	T8312012	315,00
M20	130	25	T8312013	336,00
M20	140	25	T8312014	336,00
M20	150	25	T8312015	343,00
M20	160	25	T8312016	378,00
M20	180	20	T8312018	420,00
M20	200	20	T8312020 *	462,00
M22	70	50	T8312270 *	245,00
M22	80	50	T8312280	273,00
M22	90	25	T8312290 *	301,00
M22	100	20	T8312210 *	329,00
M22	110	30	T8312211 *	350,00
M24	100	30	T8312410	413,00
M24	110	30	T8312411	448,00
M24	120	30	T8312412	483,00
M24	130	30	T8312413 *	504,00
M24	140	25	T8312414 *	532,00
M24	150	25	T8312415	574,00
M24	160	25	T8312416 *	616,00
M24	180	20	T8312418 *	679,00
M24	200	20	T8312420 *	742,00
M27	120	10	T8312712 *	672,00
M30	130	25	T8313013	896,00
M33	140	5	T8313314 *	1.253,00



PARAFUSO HEXAGONAL DIN 933 - 8.8 - Zincado

NEW



MEDIDA	COMPRIMENTO		COD.	€ 100 UNID.
M16	30	50	T8331630	67,20
M16	35	50	T8331635	70,15
M16	40	50	T8331640	77,20
M16	45	50	T8331645	83,30
M16	60	50	T8331660	95,75
M16	70	50	T8331670	107,75
M16	80	25	T8331680	121,05
M16	90	25	T8331690	133,55
M16	100	25	T8331610	146,30
M18	50	50	T8331850	109,20
M20	50	25	T8332050	131,60
M20	60	25	T8332060	152,95
M20	70	25	T8332070	179,55
M20	80	25	T8332080	199,50
M20	90	25	T8332090	239,40
M20	100	25	T8332010	259,35
M24	60	60	T8332460	270,60
M24	70	50	T8332470	305,40
M24	100	30	T8332410	392,35

* Os parafusos 6,8 estão disponíveis até fim de existência.

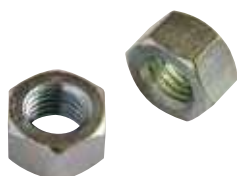
**PORCA HEXAGONAL
DIN 934 - 8 - Zincado**

MEDIDA		COD.	€ 100 UNID.
M4	250	T9340004	1,15
M5	250	T9340005	1,15
M6	150	T9340006	1,15
M8	125	T9340008	3,45
M10	100	T9340010	5,75
M12	100	T9340012	10,35
M14	50	T9340014	12,65
M16	50	T9340016	17,25
M18	25	T9340018	26,45
M20	25	T9340020	31,05
M22	20	T9340022	43,70
M24	10	T9340024	60,95
M27	10	T9340027	98,90
M30	10	T9340030	132,25
M33	5	T9340033	178,25

**ANILHA PLANA
DIN 125 - Zincado**

MEDIDA		COD.	€ 100 UNID.
M4	300	T1250004	1,60
M5	300	T1250005	1,60
M6	150	T1250006	1,60
M8	125	T1250008	1,60
M10	100	T1250010	4,80
M12	100	T1250012	6,40
M14	70	T1250014	9,60
M16	70	T1250016	11,20
M18	50	T1250018	16,00
M20	50	T1250020	17,60
M22	50	T1250022	19,20
M24	50	T1250024	35,20
M27	50	T1250027	46,40
M30	50	T1250030	57,60
M33	30	T1250033	81,60

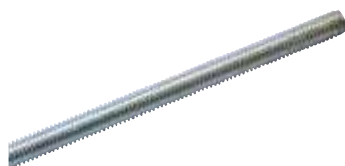
**VARÃO ROSCADO
1.000 MM - DIN 975 - 4.8 - Zincado**

MEDIDA		COD.	€ 100 UNID.
M4	100	T9750004	59,80
M5	100	T9750005	60,95
M6	50	T9750006	72,45
M8	25	T9750008	126,50
M10	25	T9750010	201,25
M12	20	T9750012	276,00
M14	15	T9750014	402,50
M16	10	T9750016	523,25
M18	5	T9750018	644,00
M20	5	T9750020	816,50
M22	5	T9750022	1.017,75
M24	5	T9750024	1.224,75
M27	4	T9750027	1.713,50
M30	2	T9750030	1.753,75

**ANILHA ABA LARGA
DIN 9021 - Zincado**

MEDIDA		COD.	€ 100 UNID.
M6	100	T9021006	3,20
M8	100	T9021008	8,00
M10	50	T9021010	14,40
M12	40	T9021012	32,00
M14	40	T9021014	46,40
M16	30	T9021016	52,80
M18	30	T9021018	97,60
M20	30	T9021020	107,20

BOBINE RANHURADA, ROSCADA, SOLDAR AÇO EN 10255 (M/S195T)



Ø	L mm.			TIPO	COD.	€
1 1/2"	70	50	10	RR-G	BRRG0770	3,90
2"	70	33	3	RR-G	BRRG0870	5,75
2 1/2"	70	12	2	RR-G	BRRG0B70	8,35
3"	70	12	2	RR-G	BRRG0A70	10,10
1"	80	100	10	RR-G	BRRG0580	2,65
1 1/4"	80	60	10	RR-G	BRRG0680	3,50
1 1/2"	80	50	10	RR-G	BRRG0780	4,00
2"	80	30	3	RR-G	BRRG0880	5,55
2 1/2"	80	12	2	RR-G	BRRG0B80	8,60
3"	80	12	2	RR-G	BRRG0A80	10,20
3"	110	9	1	RR-G	BRRGA110	12,80
4"	150	4	1	RR-G	BRRGC150	21,60
2"	100	24	3	RS-N	BRSN8100	7,00
2 1/2"	100	12	2	RS-N	BRSNB100	10,30
3"	100	10	1	RS-N	BRSNA100	12,50
4"	100	4	1	RS-N	BRSNC100	15,80

RR-G = RANHURA – ROSCA GALVANIZADA
RS-N = RANHURA – SOLDAR NEGRO

BOBINE DE AUMENTO ROSCA CÔNICA DIN 2981 GALVANIZADA AÇO ST 37,2



Ø	COMPRIM			COD.	€
3/8"	100	230	10	B5322100	2,60
1/2"	100	140	10	B5323100	2,75
3/4"	120	70	10	B5324120	3,15
1"	140	50	10	B5325140	4,35
1 1/4"	150	25	5	B5326150	5,95
1 1/2"	150	20	5	B5327150	6,95
2"	170	12	4	B5328170	9,70

BOBINE ROSCADA POR UM EXTREMO ROSCA CÔNICA ISO 7/1 (EN 10226-1) DIN 2982 (EN 10241) AÇO NEGRO ST 37,2



Ø	COMPRIM			COD.	€
1/4"	40	500	20	B6000140	1,25
3/8"	40	450	10	B6000240	0,85
3/8"	100	230	10	B6002100	1,20
3/8"	150	120	10	B6002150	1,35
3/8"	200	80	10	B6002200	1,80
3/8"	250	60	10	B6002250	2,35
3/8"	300	80	10	B6002300	2,45
1/2"	40	370	10	B6000340	1,00
1/2"	100	140	10	B6003100	1,05
1/2"	150	100	10	B6003150	1,30
1/2"	200	70	10	B6003200	1,75
1/2"	250	70	10	B6003250	2,20
1/2"	300	70	10	B6003300	2,45
3/4"	40	220	10	B6000440	1,10
3/4"	50	220	10	B6000450	1,10
3/4"	100	100	10	B6004100	1,25
3/4"	150	60	10	B6004150	1,60
3/4"	200	50	10	B6004200	2,45
3/4"	250	40	10	B6004250	2,90
3/4"	300	50	10	B6004300	3,25
1"	40	140	10	B6000540	1,40
1"	50	140	10	B6000550	1,40
1"	100	60	10	B6005100	1,70
1"	150	40	10	B6005150	2,30
1"	200	30	10	B6005200	3,10
1"	250	30	10	B6005250	3,75
1"	300	30	10	B6005300	4,35
1 1/4"	50	60	10	B6000650	1,70
1 1/4"	100	40	10	B6006100	2,25
1 1/4"	150	25	5	B6006150	3,10
1 1/4"	200	20	5	B6006200	4,05
1 1/4"	250	15	5	B6006250	5,05
1 1/4"	300	20	5	B6006300	5,60

Ø	COMPRIM			COD.	€
1 1/2"	50	40	10	B6000750	1,60
1 1/2"	100	30	5	B6007100	2,80
1 1/2"	150	20	5	B6007150	3,65
1 1/2"	200	15	5	B6007200	4,90
1 1/2"	250	10	5	B6007250	5,80
1 1/2"	300	20	5	B6007300	7,10
2"	60	30	5	B6000860	2,60
2"	100	20	5	B6008100	3,50
2"	150	12	4	B6008150	4,85
2"	200	12	4	B6008200	6,10
2"	250	9	3	B6008250	7,35
2"	300	12	4	B6008300	8,65
2 1/2"	60	18	6	B6000A60	3,75
2 1/2"	100	12	4	B600A100	5,45
2 1/2"	150	6	3	B600A150	7,50
2 1/2"	200	6	3	B600A200	9,60
2 1/2"	250	4	4	B600A250	11,85
2 1/2"	300	8	4	B600A300	13,70
3"	60	12	4	B6000B60	4,70
3"	80	12	4	B6000B80	5,80
3"	100	8	2	B600B100	6,60
3"	150	6	2	B600B150	8,95
3"	200	4	2	B600B200	12,05
3"	250	4	2	B600B250	13,70
3"	300	6	2	B600B300	16,10
4"	80	5	1	B6000C80	7,20
4"	100	4	2	B600C100	9,55
4"	150	3	1	B600C150	13,65
4"	200	6	2	B600C200	15,10
4"	250	4	2	B600C250	18,70
4"	300	3	1	B600C300	22,05

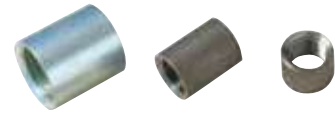

UNIÃO E MEIA UNIÃO ROSCA CILÍNDRICA ISO 7/1 (EN 10226-1) DIN 2986 (EN 10241) AÇO ST 37,2

UNIÃO						
Ø	COMPRIM		COD. NEGRO	€	COD. ZINCADO	€
1/8"	17	1000 10	M1100000	0,48	M5100000	0,66
1/4"	25	500 10	M1100001	0,57	M5100001	0,66
3/8"	26	400 10	M1100002	0,57	M5100002	0,74
1/2"	34	200 10	M1100003	0,66	M5100003	0,84
1/2"	50	170 10	M1100350	1,20		
1/2"	60	170 10	M1100063	1,30		
3/4"	36	160 10	M1100004	0,89	M5100004	1,10
3/4"	48	120 10			M5100484	1,35
1"	43	100 10	M1100005	1,10	M5100005	1,75
1 1/4"	48	60 10	M1100006	1,75	M5100006	2,15
1 1/2"	48	50 10	M1100007	2,15	M5100007	2,80
2"	56	24 4	M1100008	3,15	M5100008	3,90
2 1/2"	65	18 3	M110000A	6,25	M510000A	7,00
3"	71	24 1	M110000B	7,30	M510000B	9,35
4"	83	12 1	M110000D	13,60	M510000D	17,80
5"	92	6 1	M110000F	19,90	M510000F	27,05
6"	92	4 1	M110000G	40,65	M510000G	51,25

MEIA UNIÃO					
Ø	COMPRIM		COD. NEGRO	€	
1/4"	11	800 10	M1400001	0,48	
3/8"	12	800 10	M1400002	0,48	
1/2"	15	400 10	M1400003	0,57	
3/4"	17	300 10	M1400004	0,82	
1"	19,5	180 10	M1400005	1,10	
1 1/4"	22	120 10	M1400006	1,60	
1 1/2"	22	90 10	M1400007	1,90	
2"	26	48 8	M1400008	2,70	
2 1/2"	30,5	36 12	M140000A	5,55	
3"	34	24 12	M140000B	5,55	
4"	40	10 2	M140000D	10,45	



BOBINE ROSCADA AMBOS EXTREMOS ROSCA CÓNICA ISO 7/1 (EN 10226-1) DIN 2982 (EN 10241)

Ø	COMPRIM		COD. NEGRO	€	COD. ZINCADO	€
1/8"	50	500 20			B5100050	0,65
1/8"	60	500 20			B5100060	0,70
1/4"	40	500 20	B1100140	1,30		
1/4"	50	500 20	B1100150	1,35	B5100150	1,50
1/4"	60	500 20	B1100160	1,45	B5100160	1,55
1/4"	80	200 20	B1100180	1,60	B5100180	1,75
1/4"	100	200 20	B1101100	1,80	B5101100	1,95
1/4"	120	200 20	B1101120	1,95	B5101120	2,05
1/4"	150	120 20	B1101150	2,20	B5101150	2,35
1/4"	200	90 10	B1101200	2,60	B5101200	2,90
1/4"	250	90 10	B1101250	3,10		
1/4"	300	90 10	B1101300	3,80		
3/8"	40	450 10	B1100240	0,85	B5100240	0,95
3/8"	50	250 10	B1100250	0,85	B5100250	1,10
3/8"	60	320 10	B1100260	1,20	B5100260	1,30
3/8"	70	230 10	B1100270	1,20	B5100270	1,30
3/8"	80	280 10	B1100280	1,20	B5100280	1,30
3/8"	90	210 10	B1100290	1,30	B5100290	1,45
3/8"	100	230 10	B1102100	1,30	B5102100	1,45
3/8"	120	200 10	B1102120	1,35	B5102120	1,55
3/8"	140	180 10	B1102140	1,45	B5102140	1,75
3/8"	150	120 10	B1102150	1,55	B5102150	2,05
3/8"	160	90 10	B1102160	1,95	B5102160	2,20
3/8"	180	90 10	B1102180	2,20	B5102180	2,20
3/8"	200	80 10	B1102200	2,20	B5102200	2,30
3/8"	250	60 10	B1102250	2,30	B5102250	3,00
3/8"	300	80 10	B1102300	2,65	B5102300	3,40
3/8"	400	60 10	B1102400	3,55	B5102400	4,60
3/8"	500	60 10	B1102500	4,15	B5102500	6,35
3/8"	1000	1			B5121000	Cons.
1/2"	30	520 10	B1100330	0,75	B5100330	0,90
1/2"	40	370 10	B1100340	0,90	B5100340	0,95
1/2"	50	300 10	B1100350	0,90	B5100350	1,05
1/2"	60	250 10	B1100360	0,95	B5100360	1,05
1/2"	70	240 10	B1100370	1,00	B5100370	1,15
1/2"	80	210 10	B1100380	1,05	B5100380	1,30
1/2"	90	150 10	B1100390	1,10	B5100390	1,30
1/2"	100	140 10	B1103100	1,10	B5103100	1,30

Ø	COMPRIM		COD. NEGRO	€	COD. ZINCADO	€
1/2"	110	140 10	B1103110	1,20		
1/2"	120	120 10	B1103120	1,30	B5103120	1,50
1/2"	140	80 10	B1103140	1,45	B5103140	1,75
1/2"	150	110 10	B1103150	1,45	B5103150	1,75
1/2"	160	100 10	B1103160	1,50	B5103160	1,85
1/2"	180	100 10	B1103180	1,60	B5103180	2,05
1/2"	200	70 10	B1103200	1,70	B5103200	2,10
1/2"	220	70 10	B1103220	2,10		
1/2"	250	70 10	B1103250	2,35	B5103250	2,80
1/2"	300	70 10	B1103300	2,60	B5103300	3,25
1/2"	400	50 5	B1103400	3,65	B5103400	4,65
1/2"	500	40 5	B1103500	4,10	B5103500	5,35
1/2"	600	1			B5103600	Cons.
1/2"	800	1			B5103800	Cons.
1/2"	1000	1	B1131000	Cons.	B5131000	Cons.
1/2"	1500	1			B5131500	Cons.
1/2"	2000	1			B5132000	Cons.
3/4"	30	230 10			B5100430	0,90
3/4"	40	220 10	B1100440	0,90	B5100440	1,10
3/4"	50	180 10	B1100450	0,90	B5100450	1,10
3/4"	60	150 10	B1100460	1,05	B5100460	1,30
3/4"	70	130 10			B5100470	1,30
3/4"	80	120 10	B1100480	1,20	B5100480	1,35
3/4"	90	120 10			B5100490	1,50
3/4"	100	100 10	B1104100	1,30	B5104100	1,75
3/4"	110	100 10			B5104110	1,75
3/4"	120	70 10	B1104120	1,50	B5104120	1,80
3/4"	140	70 10	B1104140	1,70	B5104140	2,20
3/4"	150	60 10	B1104150	1,70	B5104150	2,30
3/4"	160	60 10	B1104160	1,80	B5104160	2,30
3/4"	180	60 10	B1104180	2,00	B5104180	2,50
3/4"	200	50 10	B1104200	2,05	B5104200	2,65
3/4"	250	40 10	B1104250	2,85	B5104250	3,60
3/4"	300	50 10	B1104300	3,30	B5104300	4,10
3/4"	400	30 5	B1104400	4,40	B5104400	5,55
3/4"	500	30 5	B1104500	5,30	B5104500	6,45
3/4"	600	1			B5104600	Cons.
3/4"	800	1			B5104800	Cons.
3/4"	1000	1			B5141000	Cons.
3/4"	1500	1			B5141500	Cons.
3/4"	2000	1			B5142000	Cons.

BOBINE ROSCADA AMBOS EXTREMOS ROSCA CÓNICA ISO 7/1 (EN 10226-1) DIN 2982 (EN 10241)

Ø	COMPRIM		COD. NEGRO	€	COD. ZINCADO	€
1"	40	140 10	B1100540	1,45	B5100540	1,45
1"	50	140 10	B1100550	1,45	B5100550	1,45
1"	60	120 10	B1100560	1,45	B5100560	1,60
1"	70	100 10			B5100570	1,85
1"	80	80 10	B1100580	1,55	B5100580	1,85
1"	90	80 10			B5100590	2,20
1"	100	60 10	B1105100	1,80	B5105100	2,30
1"	120	60 10	B1105120	2,00	B5105120	2,35
1"	140	50 10	B1105140	2,30	B5105140	2,75
1"	150	40 10	B1105150	2,35	B5105150	2,75
1"	160	40 10	B1105160	2,60	B5105160	3,00
1"	180	40 10	B1105180	2,75	B5105180	3,10
1"	200	30 10	B1105200	3,00	B5105200	3,50
1"	250	30 10	B1105250	3,90	B5105250	4,40
1"	300	30 10	B1105300	4,65	B5105300	5,35
1"	400	25 5	B1105400	6,20	B5105400	7,20
1"	500	20 5	B1105500	7,50	B5105500	8,50
1"	600	1			B5105600	Cons.
1"	800	1			B5105800	Cons.
1"	1000	1			B5151000	Cons.
1"	1500	1			B5151500	Cons.
1"	2000	1			B5152000	Cons.
1 1/4"	40	80 10	B1100640	1,75	B5100640	1,95
1 1/4"	50	60 10	B1100650	1,95	B5100650	1,95
1 1/4"	60	60 10	B1100660	1,95	B5100660	2,20
1 1/4"	70	40 10	B1100670	2,20	B5100670	2,20
1 1/4"	80	50 10	B1100680	2,20	B5100680	2,20
1 1/4"	100	40 10	B1106100	2,25	B5106100	2,65
1 1/4"	120	30 10	B1106120	2,60	B5106120	3,10
1 1/4"	140	25 5	B1106140	3,05	B5106140	3,65
1 1/4"	150	25 5	B1106150	3,10	B5106150	3,65
1 1/4"	160	25 5	B1106160	3,30	B5106160	4,00
1 1/4"	180	25 5	B1106180	3,60	B5106180	4,10
1 1/4"	200	20 5	B1106200	3,75	B5106200	4,45
1 1/4"	250	15 5	B1106250	5,10	B5106250	5,90
1 1/4"	300	20 5	B1106300	5,85	B5106300	6,75
1 1/4"	400	16 2	B1106400	8,45	B5106400	9,95
1 1/4"	500	16 2	B1106500	10,30	B5106500	12,00
1 1/4"	600	1			B5106600	Cons.
1 1/4"	800	1			B5106800	Cons.
1 1/4"	1000	1			B5161000	Cons.
1 1/2"	40	80 10	B1100740	2,10	B5100740	2,20
1 1/2"	50	40 10	B1100750	2,20	B5100750	2,30
1 1/2"	60	50 10	B1100760	2,20	B5100760	2,35
1 1/2"	70	40 10			B5100770	2,75
1 1/2"	80	40 10	B1100780	2,35	B5100780	2,75
1 1/2"	100	30 5	B1107100	2,65	B5107100	3,05
1 1/2"	120	25 5	B1107120	3,05	B5107120	3,50
1 1/2"	140	20 5	B1107140	3,40	B5107140	4,05
1 1/2"	150	20 5	B1107150	3,50	B5107150	4,40
1 1/2"	160	20 5	B1107160	4,00	B5107160	4,55
1 1/2"	180	20 5	B1107180	4,55	B5107180	5,10
1 1/2"	200	15 5	B1107200	4,55	B5107200	5,35
1 1/2"	250	10 5	B1107250	5,65	B5107250	6,50
1 1/2"	300	20 5	B1107300	6,85	B5107300	7,80
1 1/2"	400	12 2	B1107400	9,80	B5107400	11,25
1 1/2"	500	12 2	B1107500	11,60	B5107500	13,70
1 1/2"	600	1			B5107600	Cons.
1 1/2"	700	1			B5107700	Cons.
1 1/2"	800	1			B5107800	Cons.
1 1/2"	1000	1			B5171000	Cons.



Ø	COMPRIM		COD. NEGRO	€	COD. ZINCADO	€
2"	40	40 5			B5100840	2,90
2"	50	40 5			B5100850	3,35
2"	60	30 5	B1100860	2,90	B5100860	3,40
2"	80	24 6	B1100880	3,10	B5100880	3,40
2"	90	20 5			B5100890	3,40
2"	100	20 5	B1108100	3,15	B5108100	4,10
2"	120	16 4	B1108120	3,90	B5108120	4,95
2"	140	12 4	B1108140	4,95	B5108140	5,65
2"	150	12 4	B1108150	5,05	B5108150	5,70
2"	160	12 4	B1108160	5,35	B5108160	6,40
2"	180	12 4	B1108180	5,80	B5108180	6,75
2"	200	12 4	B1108200	6,15	B5108200	7,00
2"	250	9 3	B1108250	8,05	B5108250	8,95
2"	300	12 4	B1108300	8,95	B5108300	11,00
2"	400	10 2	B1108400	13,05	B5108400	15,35
2"	500	12 2	B1108500	15,60	B5108500	18,25
2"	600	1			B5108600	Cons.
2"	800	1			B5108800	Cons.
2"	1000	1			B5181000	Cons.
2 1/2"	80	12 4	B1100A80	5,60	B5100A80	5,95
2 1/2"	100	12 4	B110A100	5,85	B510A100	6,50
2 1/2"	120	8 4	B110A120	7,40	B510A120	7,25
2 1/2"	140	6 3	B110A140	7,45	B510A140	7,95
2 1/2"	150	6 3	B110A150	7,60	B510A150	8,45
2 1/2"	160	6 3	B110A160	8,05	B510A160	9,00
2 1/2"	180	6 3	B110A180	9,40	B510A180	10,55
2 1/2"	200	6 3	B110A200	9,80	B510A200	11,30
2 1/2"	250	4 4	B110A250	11,85	B510A250	12,80
2 1/2"	300	8 2	B110A300	13,60	B510A300	15,15
2 1/2"	400	6 2			B510A400	20,35
2 1/2"	500	5 1			B510A500	24,65
2 1/2"	600	1			B510A600	Cons.
2 1/2"	800	1			B510A800	Cons.
2 1/2"	1000	1			B51A1000	Cons.
3"	80	12 4	B1100B80	6,50	B5100B80	7,45
3"	100	8 2	B110B100	7,15	B510B100	7,75
3"	120	8 2	B110B120	8,00	B510B120	8,70
3"	140	4 2	B110B140	8,65	B510B140	9,70
3"	150	6 2	B110B150	8,90	B510B150	10,00
3"	160	4 2			B510B160	10,55
3"	180	4 2	B110B180	10,45	B510B180	11,85
3"	200	4 2	B110B200	12,35	B510B200	14,35
3"	250	4 2	B110B250	15,25	B510B250	16,65
3"	300	6 2	B110B300	16,75	B510B300	18,80
3"	400	4 2			B510B400	33,10
3"	500	4 2			B510B500	41,85
4"	80	5 1	B1100C80	11,35	B5100C80	11,85
4"	100	4 2	B110C100	12,25	B510C100	13,05
4"	120	3 1	B110C120	13,90	B510C120	14,70
4"	140	3 1	B110C140	14,10	B510C140	14,70
4"	150	3 1	B110C150	14,40	B510C150	15,40
4"	160	3 1	B110C160	14,90	B510C160	15,40
4"	180	2 1	B110C180	15,65	B510C180	16,65
4"	200	6 2	B110C200	16,45	B510C200	20,40
4"	250	4 2	B110C250	20,60	B510C250	22,55
4"	300	3 1	B110C300	25,25	B510C300	27,70
4"	400	3 1			B510C400	56,20
4"	500	3 1			B510C500	65,20

ACESSÓRIOS DE **AÇO INOXIDÁVEL**

Os aços inoxidáveis são ligas ferríticas com uma quantidade de carbono (C), inferior a 2%.

A característica principal dos aços inoxidáveis é de apresentar uma ótima resistência à corrosão, devido ao facto de um dos seus componentes principais ser o Crómio (CR), este está presente na liga com uma percentagem nunca inferior a 12%.

PRINCIPAIS GRUPOS DE AÇOS INOXIDÁVEIS

- Aços Ferríticos: Fe + Cr (12-30%) + C (0.02-0.1%).
- Aços Martensíticos: Fe + Cr (12-19%) + C (0.08-1.2%).
- Aços Austeníticos: Fe + Cr (16-28%) + C (0.02-0.1%) + Ni (6-32%)

As características dos aços austeníticos (gama presente neste catálogo)

Os aspectos que se destacam nesta categoria de aços são a óptima resistência à oxidação e as suas notáveis capacidades mecânicas a altas temperaturas.

Os aços inoxidáveis austeníticos são normalmente utilizados em todas as aplicações nas quais se requer materiais capazes de suportar exigentes condições de serviço.

Os principais são:

AISI 304 (EN1.4301): Apresenta características de elevada resistência a fadiga e uma baixa sensibilidade aos impactos, esta particularmente indicado para utilização a baixas temperaturas.

AISI 316 (EN 1.4401): O AISI 316 distingue-se do 304 pela presença de Molibdeno (Mo) na sua composição (2-3%) conferindo-lhe mais resistência à corrosão e melhorando as capacidades mecânicas a elevadas temperaturas.

O AISI 304L (EN 1.4307) e o 316L (EN 1.4404), distinguem-se dos anteriores por ter na sua composição menos Carbono (C) permitindo efectuar soldaduras a temperaturas mais altas. As restantes características são similares ao 304 e ao 316 quando utilizados a temperatura ambiente, na utilização a temperaturas mais elevadas o desempenho é ligeiramente inferior.

The logo for ATUSA, featuring a stylized diamond shape to the left of the word "ATUSA" in a bold, sans-serif font.

▶ **ATUSA**

ACESSÓRIOS
INOXIDÁVEL

A close-up photograph of a stainless steel hex nut, showing its internal threads and the hexagonal shape. The background is a vibrant green with a circular light effect around the nut.

ACESSÓRIOS
AÇO
INOXIDÁVEL

ACESSÓRIOS ROSCADOS AISI 316

90 JOELHO F/F 90°

Ø			COD.	€
1/8"	400	10	I0906000	1,45
1/4"	400	10	I0906001	1,80
3/8"	290	10	I0906002	2,15
1/2"	160	10	I0906003	2,35
3/4"	80	10	I0906004	3,80
1"	50	10	I0906005	6,50
1 1/4"	24	4	I0906006	9,75
1 1/2"	18	2	I0906007	14,10
2"	10	1	I0906008	19,90
2 1/2"	6	1	I0906009	37,10
3"	3	1	I090600A	54,60
4"	1		I090600C	96,85

92 JOELHO M/F 90°

Ø			COD.	€
1/8"	500	10	I0926000	1,10
1/4"	350	10	I0926001	2,35
3/8"	260	10	I0926002	2,45
1/2"	160	10	I0926003	2,90
3/4"	100	10	I0926004	4,05
1"	50	10	I0926005	7,00
1 1/4"	25	5	I0926006	10,10
1 1/2"	18	2	I0926007	12,95
2"	10	1	I0926008	22,10
2 1/2"	4	1	I0926009	42,15
3"	3	1	I092600A	58,45
4"	1		I092600C	109,60

96 JOELHO C/JUNÇÃO S/C FÊMEA

Ø			COD.	€
1/2"	50	5	I0966003	9,35
3/4"	40	5	I0966004	14,35
1"	20	2	I0966005	20,40
1 1/4"	15	1	I0966006	30,05
1 1/2"	12	1	I0966007	40,65
2"	6	1	I0966008	59,55

98 JOELHO C/JUNÇÃO S/C M/F

Ø			COD.	€
1/2"	50	5	I0986003	11,20
3/4"	30	5	I0986004	16,30
1"	14	2	I0986005	21,80
1 1/4"	12	1	I0986006	33,90
1 1/2"	8	1	I0986007	46,95
2"	6	1	I0986008	66,30

120 JOELHO SIMPLES 45°

Ø			COD.	€
1/4"	400	10	I1206001	1,50
3/8"	300	10	I1206002	2,15
1/2"	150	5	I1206003	2,50
3/4"	90	5	I1206004	3,50
1"	60	5	I1206005	5,95
1 1/4"	30	1	I1206006	9,40
1 1/2"	20	1	I1206007	12,15
2"	12	1	I1206008	18,05
2 1/2"	8	1	I1206009	47,90
3"	4	1	I120600A	62,85

121 JOELHO SIMPLES M/F 45°

Ø			COD.	€
1/4"	400	10	I1216001	1,50
3/8"	200	10	I1216002	2,10
1/2"	150	5	I1216003	2,70
3/4"	90	5	I1216004	3,95
1"	60	5	I1216005	6,85
1 1/4"	30	1	I1216006	9,60
1 1/2"	20	1	I1216007	12,60
2"	12	1	I1216008	20,40
2 1/2"	8	1	I1216009	48,85
3"	4	1	I121600A	63,30



130 TÊ



130R TÊ DE REDUÇÃO

Ø		COD.	€
1/8"	380 10	I1306000	1,60
1/4"	250 10	I1306001	2,35
3/8"	160 10	I1306002	3,05
1/2"	100 5	I1306003	3,55
3/4"	50 5	I1306004	5,55
1"	30 5	I1306005	9,00
1 1/4"	18 2	I1306006	13,20
1 1/2"	14 2	I1306007	18,05
2"	10 1	I1306008	25,40
2 1/2"	4 1	I1306009	46,40
3"	2 1	I130600A	72,10
4"	1	I130600C	128,75

Ø		COD.	€
1/2" x 3/8" x 1/2"	120 5	I1306323	5,50
3/4" x 1/2" x 3/4"	60 5	I1306434	6,55
1" x 1/2" x 1"	40 5	I1306535	7,20
1" x 3/4" x 1"	30 5	I1306545	8,35
1" x 1" x 1/2"	30 5	I1306553	8,60



180 CRUZETA

Ø		COD.	€
1/8"	250 10	I1806000	3,90
1/4"	160 10	I1806001	4,90
3/8"	120 10	I1806002	5,00
1/2"	60 10	I1806003	5,15
3/4"	36 6	I1806004	7,20
1"	20 5	I1806005	11,60
1 1/4"	16 4	I1806006	20,50
1 1/2"	12 4	I1806007	23,35
2"	6 2	I1806008	34,95
2 1/2"	3 1	I1806009	61,30
3"	2 1	I180600A	103,55
4"	1	I180600C	202,80



241 PORCA DE REDUÇÃO M/F

Ø		COD.	€
1/4" x 1/8"	650 10	I2416010	1,25
3/8" x 1/8"	580 10	I2416020	1,25
3/8" x 1/4"	580 10	I2416021	1,60
1/2" x 1/8"	500 10	I2416030	2,25
1/2" x 1/4"	380 10	I2416031	2,10
1/2" x 3/8"	400 10	I2416032	1,80
3/4" x 1/4"	240 5	I2416041	3,20
3/4" x 3/8"	250 5	I2416042	3,05
3/4" x 1/2"	240 5	I2416043	2,70
1" x 3/8"	120 10	I2416052	3,50
1" x 1/2"	140 5	I2416053	3,35
1" x 3/4"	140 5	I2416054	3,50
1 1/4" x 1/2"	100 5	I2416063	5,70
1 1/4" x 3/4"	80 5	I2416064	5,55
1 1/4" x 1"	100 5	I2416065	4,90
1 1/2" x 1/2"	60 5	I2416073	7,60
1 1/2" x 3/4"	60 5	I2416074	7,40
1 1/2" x 1"	70 2	I2416075	7,10
1 1/2" x 1 1/4"	70 2	I2416076	5,60
2" x 1/2"	35 5	I2416083	12,35
2" x 3/4"	35 5	I2416084	12,35
2" x 1"	30 5	I2416085	12,25
2" x 1 1/4"	30 5	I2416086	11,90
2" x 1 1/2"	30 2	I2416087	10,55
2 1/2" x 1"	24 2	I2416095	25,05
2 1/2" x 1 1/4"	24 4	I2416096	21,05
2 1/2" x 1 1/2"	24 2	I2416097	21,70
2 1/2" x 2"	24 2	I2416098	17,85
3" x 2"	16 1	I24160A8	34,25
3" x 2 1/2"	16 1	I24160A9	31,75
4" x 2"	8 1	I24160C8	71,70
4" x 2 1/2"	8 1	I24160C9	73,40
4" x 3"	8 1	I24160CA	64,10



240 UNIÃO DE REDUÇÃO

Ø		COD.	€
1/4" x 1/8"	300 10	I2406010	2,35
3/8" x 1/4"	300 10	I2406021	2,50
1/2" x 1/4"	150 10	I2406031	2,50
1/2" x 3/8"	200 10	I2406032	2,50
3/4" x 1/4"	140 10	I2406041	4,80
3/4" x 1/2"	120 5	I2406043	3,80
1" x 1/2"	90 5	I2406053	4,90
1" x 3/4"	70 5	I2406054	4,90
1 1/4" x 3/4"	60 5	I2406064	7,80
1 1/4" x 1"	40 5	I2406065	7,80
1 1/2" x 1"	40 5	I2406075	8,75
1 1/2" x 1 1/4"	30 5	I2406076	10,25
2" x 1"	30 5	I2406085	14,60
2" x 1 1/4"	25 5	I2406086	14,60
2" x 1 1/2"	25 5	I2406087	15,45
2 1/2" x 2"	12 2	I2406098	23,10
3" x 2"	12 2	I24060A8	41,65



245 CASQ. DUPLO REDUÇÃO M/M



270 UNIÃO SIMPLES

Ø	Box		COD.	€
1/4" x 1/8"	520	10	I2456010	1,15
3/8" x 1/8"	400	10	I2456020	1,95
3/8" x 1/4"	400	10	I2456021	1,80
1/2" x 1/4"	280	10	I2456031	3,50
1/2" x 3/8"	200	10	I2456032	3,35
3/4" x 1/4"	200	10	I2456041	3,55
3/4" x 3/8"	100	10	I2456042	3,95
3/4" x 1/2"	180	10	I2456043	4,05
1" x 1/2"	100	5	I2456053	4,05
1" x 3/4"	100	5	I2456054	5,90
1 1/4" x 1/2"	60	5	I2456063	7,00
1 1/4" x 3/4"	70	5	I2456064	7,00
1 1/4" x 1"	60	5	I2456065	7,00
1 1/2" x 1/2"	45	3	I2456073	8,55
1 1/2" x 3/4"	54	3	I2456074	8,55
1 1/2" x 1"	40	2	I2456075	8,55
1 1/2" x 1 1/4"	36	2	I2456076	8,55
2" x 1"	28	2	I2456085	13,35
2" x 1 1/4"	30	2	I2456086	13,35
2" x 1 1/2"	26	2	I2456087	13,35
2 1/2" x 1"	12	2	I2456095	31,75
2 1/2" x 1 1/4"	12	2	I2456096	30,50
2 1/2" x 1 1/2"	12	2	I2456097	28,65
2 1/2" x 2"	20	1	I2456098	28,05
3" x 2"	10	1	I24560A8	39,10
3" x 2 1/2"	10	1	I24560A9	36,75

Ø	Box		COD.	€
1/8"	800	10	I2706000	1,35
1/4"	450	10	I2706001	1,50
3/8"	400	10	I2706002	1,95
1/2"	240	10	I2706003	2,75
3/4"	180	5	I2706004	3,90
1"	80	5	I2706005	4,95
1 1/4"	50	2	I2706006	7,20
1 1/2"	40	2	I2706007	8,35
2"	24	1	I2706008	12,00
2 1/2"	12	1	I2706009	19,20
3"	8	1	I270600A	26,50
4"	4	1	I270600C	45,20



280 CASQUILHO DUPLO

Ø	Box		COD.	€
1/8"	700	10	I2806000	1,30
1/4"	500	10	I2806001	1,95
3/8"	400	10	I2806002	2,25
1/2"	240	10	I2806003	2,35
3/4"	120	5	I2806004	3,30
1"	80	5	I2806005	4,90
1 1/4"	45	3	I2806006	7,35
1 1/2"	30	2	I2806007	10,10
2"	20	1	I2806008	13,25
2 1/2"	12	1	I2806009	28,20
3"	8	1	I280600A	38,50
4"	4	1	I280600C	58,35



285 PASSAMUROS

Ø	Box		COD.	€
3/8"	100	5	I2856002	17,35
1/2"	100	5	I2856003	19,50
3/4"	60	5	I2856004	23,10
1"	40	5	I2856005	26,40
1 1/4"	20	2	I2856006	35,80
1 1/2"	16	2	I2856007	43,00
2"	16	2	I2856008	62,10



300 TAMPÃO FÊMEA

Ø	Box		COD.	€
1/8"	600	10	I3006000	1,10
1/4"	600	10	I3006001	1,20
3/8"	400	10	I3006002	1,30
1/2"	250	5	I3006003	2,10
3/4"	180	5	I3006004	2,40
1"	120	5	I3006005	4,10
1 1/4"	60	3	I3006006	6,10
1 1/2"	46	2	I3006007	8,15
2"	30	1	I3006008	13,25
2 1/2"	20	1	I3006009	26,05
3"	12	1	I300600A	31,50
4"	8	1	I300600C	48,55



290 TAMPÃO MACHO

Ø	Box		COD.	€
1/8"	800	10	I2906000	1,20
1/4"	600	10	I2906001	1,20
3/8"	500	10	I2906002	1,35
1/2"	300	10	I2906003	1,95
3/4"	200	5	I2906004	2,35
1"	140	5	I2906005	3,55
1 1/4"	81	3	I2906006	5,65
1 1/2"	60	3	I2906007	6,85
2"	30	1	I2906008	10,50
2 1/2"	24	1	I2906009	20,05
3"	16	1	I290600A	28,10
4"	8	1	I290600C	43,00



312 BATENTE REBAIXADO



315 CASQUILHO M P/ MANGUEIRA

Ø			COD.	€
1/8"	1000	10	I3106000	1,05
1/4"	800	10	I3106001	1,05
3/8"	600	10	I3106002	1,05
1/2"	400	5	I3106003	1,60
3/4"	300	5	I3106004	2,05
1"	200	5	I3106005	3,30
1 1/4"	120	3	I3106006	4,90
1 1/2"	100	2	I3106007	6,90
2"	10	1	I3106008	10,10
2 1/2"	25	1	I3106009	16,05
3"	20	1	I310600A	21,70
4"	10	1	I310600C	38,60

Ø			COD.	€
1/8" x 8 mm.	500	10	I3156000	2,05
1/4" x 9 mm.	500	10	I3156001	2,25
3/8" x 11 mm.	350	10	I3156002	2,80
1/2" x 15 mm.	200	10	I3156003	3,50
3/4" x 20 mm.	120	5	I3156004	5,55
1" x 27 mm.	60	5	I3156005	7,50
1 1/4" x 33 mm.	40	2	I3156006	11,55
1 1/2" x 40 mm.	35	1	I3156007	15,65
2" x 53 mm.	15	1	I3156008	22,85
2 1/2" x 66 mm.	10	1	I3156009	33,15
3" x 80 mm.	8	1	I315600A	47,05
4" x 105 mm.	2	1	I315600C	82,35



330 JUNÇÃO FÊMEA S/D

Ø			COD.	€
1/4"	120	10	I3306001	6,55
3/8"	100	10	I3306002	8,10
1/2"	100	10	I3306003	8,30
3/4"	60	10	I3306004	11,25
1"	40	10	I3306005	15,65
1 1/4"	20	5	I3306006	25,05
1 1/2"	18	3	I3306007	29,70
2"	16	2	I3306008	47,65
2 1/2"	6	2	I3306009	79,15
3"	4	1	I330600A	107,35
4"	2	1	I330600C	163,85



331 JUNÇÃO M/F S/D

Ø			COD.	€
1/4"	200	10	I3316001	6,55
3/8"	150	10	I3316002	8,85
1/2"	100	10	I3316003	9,00
3/4"	60	5	I3316004	13,15
1"	42	3	I3316005	18,05
1 1/4"	21	3	I3316006	28,20
1 1/2"	16	2	I3316007	32,95
2"	10	1	I3316008	52,05
2 1/2"	6	1	I3316009	85,65
3"	4	1	I331600A	119,60
4"	2	1	I331600C	181,60



340 JUNÇÃO FÊMEA S/C

Ø			COD.	€
1/8"	250	10	I3406000	4,80
1/4"	200	10	I3406001	6,50
3/8"	150	10	I3406002	7,95
1/2"	100	10	I3406003	8,05
3/4"	60	5	I3406004	9,55
1"	42	3	I3406005	14,25
1 1/4"	21	3	I3406006	22,50
1 1/2"	16	2	I3406007	28,60
2"	16	1	I3406008	37,05
2 1/2"	6	1	I3406009	65,35
3"	4	1	I340600A	86,40
4"	2	1	I340600C	125,30



341 JUNÇÃO M/F S/C

Ø			COD.	€
1/8"	250	10	I3416000	7,20
1/4"	200	10	I3416001	8,40
3/8"	120	10	I3416002	8,95
1/2"	100	10	I3416003	9,40
3/4"	50	5	I3416004	11,20
1"	30	3	I3416005	16,95
1 1/4"	21	3	I3416006	26,40
1 1/2"	16	2	I3416007	34,40
2"	10	1	I3416008	44,30
2 1/2"	5	1	I3416009	74,50
3"	2	1	I341600A	93,80
4"	1	1	I341600C	148,35



**JUNTA PLANA EM PTFE
PARA FIG 300 E 331**

Ø		COD.	€
1/4"	100 10	I33J0001	0,55
3/8"	100 10	I33J0002	0,55
1/2"	100 10	I33J0003	0,70
3/4"	100 10	I33J0004	0,75
1"	100 10	I33J0005	1,05
1 1/4"	100 10	I33J0006	1,45
1 1/2"	100 10	I33J0007	2,55
2"	100 10	I33J0008	3,50
2 1/2"	100 10	I33J0009	5,00
3"	100 10	I33J000A	5,00
4"	100 10	I33J000C	6,90



**531 ROSCA EXTERIOR
(UNIÃO)**

Ø		COD.	€
1/4"	1000 10	I5316001	1,75
3/8"	600 10	I5316002	2,15
1/2"	350 5	I5316003	2,75
3/4"	200 5	I5316004	2,85
1"	140 5	I5316005	4,20
1 1/4"	80 2	I5316006	5,95
1 1/2"	60 2	I5316007	6,15
2"	18 1	I5316008	8,40



530 BOBINE ROSCADA

Ø		COD.	€
1/8" x 40 mm.	800 10	I5306000	1,95
1/4" x 40 mm.	500 10	I5306001	2,00
3/8" x 40 mm.	400 10	I5306002	2,05
3/8" x 80 mm.	280 10	I5362080	4,00
3/8" x 150 mm.	120 10	I5362150	4,35
1/2" x 60 mm.	180 10	I5306003	2,85
1/2" x 80 mm.	210 10	I5363080	4,00
1/2" x 120 mm.	120 10	I5363120	4,65
1/2" x 150 mm.	110 10	I5363150	5,40
3/4" x 60 mm.	120 10	I5306004	4,15
3/4" x 100 mm.	60 10	I5364100	4,90
3/4" x 120 mm.	70 10	I5364120	5,70
3/4" x 150 mm.	60 10	I5364150	6,50
3/4" x 200 mm.	50 10	I5364200	8,40
1" x 40 mm.	140 10	I5365040	4,00
1" x 60 mm.	120 5	I5306005	4,75
1" x 80 mm.	70 10	I5365080	5,95
1" x 100 mm.	60 10	I5365100	6,40
1" x 150 mm.	40 10	I5365150	9,40
1" x 200 mm.	30 10	I5365200	11,20
1 1/4" x 80 mm.	40 2	I5306006	8,50
1 1/4" x 100 mm.	40 10	I5366100	7,40
1 1/4" x 150 mm.	25 1	I5366150	10,80
1 1/2" x 80 mm.	25 1	I5306007	8,95
1 1/2" x 150 mm.	20 1	I5367150	23,50
2" x 60 mm.	30 10	I5368060	11,95
2" x 100 mm.	18 1	I5306008	14,50
2" x 150 mm.	12 1	I5368150	25,10
2 1/2" x 100 mm.	10 1	I5306009	24,20
3" x 120 mm.	5 1	I530600A	34,15
4" x 120 mm.	2 1	I530600C	68,35



600 BOBINE ROSCAR/SOLDAR M.

Ø		COD.	€
1/8" x 30 mm.	1200 10	I6006000	1,25
1/4" x 30 mm.	500 10	I6006001	1,35
3/8" x 30 mm.	500 10	I6006002	1,45
1/2" x 35 mm.	300 5	I6006003	1,95
3/4" x 40 mm.	180 5	I6006004	2,55
1" x 40 mm.	120 5	I6006005	3,75
1 1/4" x 50 mm.	60 3	I6006006	5,55
1 1/2" x 50 mm.	40 2	I6006007	6,35
2" x 50 mm.	30 1	I6006008	8,80
2 1/2" x 60 mm.	18 1	I6006009	16,60
3" x 70 mm.	12 1	I600600A	25,00
4" x 80mm.	4 1	I600600C	40,15



**700 ENTRONQUE
ROSCA - MANGUERA**

Ø		COD.	€
1/4" x 70 mm.	400 10	I7001070	2,50
3/8" x 70 mm.	250 10	I7002070	3,10
1/2" x 70 mm.	180 10	I7003070	3,90
3/4" x 70 mm.	120 10	I7004070	4,80
1" x 70 mm.	90 5	I7005070	6,40
1 1/4" x 70 mm.	40 5	I7006070	8,40
1 1/2" x 100 mm.	25 5	I7007100	12,35
2" x 100 mm.	20 1	I7008100	16,40



**800 ENTRONQUE
MANGUERA - MANGUERA**

Ø		COD.	€
1/4" x 66 mm.	300 10	I8001066	2,50
3/8" x 76 mm.	250 10	I8002076	3,25
1/2" x 86 mm.	160 10	I8003086	4,40
3/4" x 100 mm.	80 10	I8004100	6,00
1" x 114 mm.	50 5	I8005114	8,95
1 1/4" x 114 mm.	30 5	I8006114	11,75
1 1/2" x 122 mm.	25 5	I8007122	14,85
2" x 130 mm.	15 1	I8008130	20,10

VÁLVULAS EM AÇO INOXIDÁVEL AISI 316



VÁLVULA DE ESFERA 1 CORPO

Corpo em aço inoxidável CF8M (AISI316).
Eixo em AISI 316.
Manípulo em AISI 304 revestido a PVC azul.
Assento da esfera PTFE +15% GF.
Extremos rosca ISO 7/1 (rosca R-Rp).
Temperatura de serviço: -20° C a 180° C.
Pressão de serviço: 1000 WOG/PN 63.
Sistema de bloqueio.

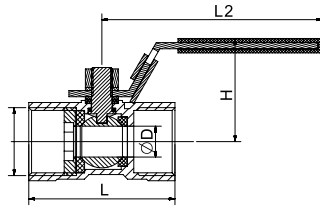

Ø	D mm.	L mm.	L2 mm.	H mm.		COD.	€
1/4"	5,0	40	62,5	30,7	200 1	IVB10061	9,70
3/8"	7,0	44	74,5	34,7	120 1	IVB10062	9,70
1/2"	9,2	56	86,5	40,7	70 1	IVB10063	11,15
3/4"	12,5	59	88,5	43,2	50 1	IVB10064	14,15
1"	15,0	71	107,0	49,2	30 1	IVB10065	19,00
1 1/4"	20,0	78	107,0	52,8	24 1	IVB10066	32,95
1 1/2"	25,0	83	132,0	66,4	16 1	IVB10067	36,35
2"	32,0	95	132,0	72,2	12 1	IVB10068	57,05



VÁLVULA DE ESFERA 2 CORPOS PASSAGEM TOTAL

Corpo em aço inoxidável CF8M (AISI316).
Eixo em AISI 316.
Manípulo em AISI 304 revestido a PVC azul.
Assento da esfera PTFE +15% GF.
Extremos rosca ISO 7/1 (rosca R-Rp).
Temperatura de serviço: -20° C a 180° C.
Pressão de serviço: 1000 WOG/PN 63.
Sistema de bloqueio.

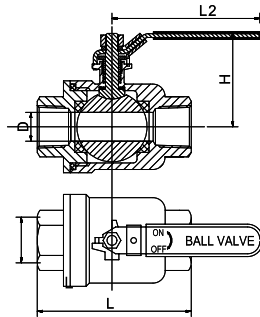

Ø	D mm.	L mm.	L2 mm.	H mm.		COD.	€
1/4"	12,5	49,0	100	47	60 1	IVB20061	13,40
3/8"	12,5	49,0	100	47	60 1	IVB20062	13,40
1/2"	15,0	56,0	102	48	45 1	IVB20063	13,55
3/4"	20,0	64,5	112	59	25 1	IVB20064	18,25
1"	25,0	78,0	120	56	16 1	IVB20065	27,05
1 1/4"	32,0	88,0	135	68	10 1	IVB20066	40,20
1 1/2"	38,0	96,5	148	83	6 1	IVB20067	55,05
2"	50,0	116,5	165	99	4 1	IVB20068	89,80
2 1/2"	65,0	146,5	235	128	4 1	IVB20069	211,35
3"	76,0	168,0	235	135	2 1	IVB2006A	306,30
4"	94,0	214,0	308	172	2 1	IVB2006C	580,15



VÁLVULA DE ESFERA TRÊS CORPOS PASSAGEM TOTAL – ROSCADA

Corpo em aço inoxidável CF8M (AISI 316).
Eixo em AISI 316.
Manípulo em AISI 304 revestido a PVC azul.
Assento da esfera em PTFE +15% GF.
Extremos roscados ISO 7/1 (Rosca R-RP).
Temperatura de serviço: -20° C a 180° C.
Pressão de serviço: 1000 WOG/PN 63.
Sistema de bloqueio.

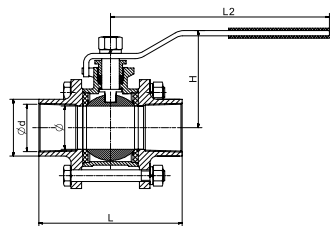

Ø	d mm.	L mm.	L2 mm.	H mm.		COD.	€
1/4"	12,50	51	100	45	40 1	IVB30061	22,30
3/8"	12,50	51	100	45	36 1	IVB30062	22,30
1/2"	15,00	62	100	49	30 1	IVB30063	22,30
3/4"	20,00	69	112	60	16 1	IVB30064	35,45
1"	25,00	79	112	64	11 1	IVB30065	40,20
1 1/4"	32,00	96	145	80	6 1	IVB30066	63,75
1 1/2"	38,00	102	145	83	4 1	IVB30067	80,40
2"	50,00	124	165	97	2 1	IVB30068	130,05
2 1/2"	65,00	159	230	118	2 1	IVB30069	258,10
3"	76,00	179	230	125	1 1	IVB3006A	373,05
4"	94,00	220	300	169	1 1	IVB3006C	678,55

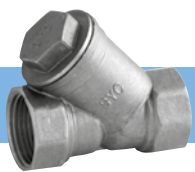

FILTRO EM "Y"

Corpo em aço inoxidável CF8M (AISI 316).
Temperatura de serviço: -20° C a 160° C.
Extremos rosca ISO 7/1 (rosca R-Rp).
Pressão de serviço: PN 50.
Junta em PTFE.

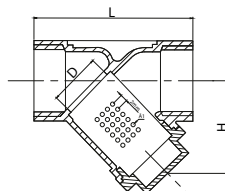

Ø	D mm.	L mm.	H mm.		COD.	€
1/2"	10	63	38	70 1	IVF00063	14,85
3/4"	20	80	55	45 1	IVF00064	19,00
1"	25	90	56	25 1	IVF00065	32,70
1 1/4"	32	108	60	14 1	IVF00066	43,05
1 1/2"	40	120	70	12 1	IVF00067	54,55
2"	50	142	82	6 1	IVF00068	82,45



TORNEIRA DE JARDIM INOX

Corpo em aço inoxidável CF8M (AISI 316).
Eixo em AISI 316.
Manípulo em SS 301 revestido a PVC azul.
O-Ring em viton.
Extremos rosca BSP.
Temperatura de serviço: -20° C a 160° C.
Pressão de serviço: PN16.

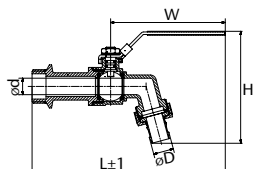

Ø	D mm.	L mm.	H mm.	W mm.		COD.	€
1/2"	13,0	145,0	87	92	40 1	IVG06003	21,40
3/4"	16,0	154,0	92	105	30 1	IVG06004	28,25
1"	27,5	183,5	115	105	20 1	IVG06005	32,55

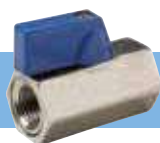

VÁLVULA ESFERA MINI F/F

Corpo em aço inoxidável CF8M (AISI 316).
Manípulo em alumínio.
Esfera em aço inoxidável CF8M.
O-ring em viton.
Extremos rosca ISO 7/1 (rosca R-Rp).

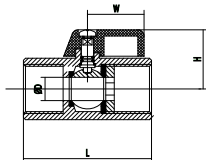

Ø	D mm.	L mm.	H mm.	W mm.		COD.	€
1/4"	7,0	42	25,0	22,8	160 1	IVBHH061	14,00
3/8"	7,0	42	25,0	22,8	160 1	IVBHH062	14,00
1/2"	9,2	47	28,3	22,8	80 1	IVBHH063	17,75



VÁLVULA ESFERA MINI M/F

Corpo em aço inoxidável CF8M (AISI 316).
Manípulo em alumínio.
Esfera em aço inoxidável CF8M.
O-ring em viton.
Extremos rosca ISO 7/1 (rosca R-Rp).

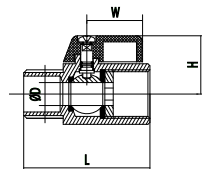

Ø	D mm.	L mm.	H mm.	W mm.		COD.	€
1/4"	7,0	42	25,0	22,8	160 1	IVBMH061	14,00
3/8"	7,0	42	25,0	22,8	160 1	IVBMH062	14,00
1/2"	9,2	47	28,3	22,8	80 1	IVBMH063	17,75



VÁLVULA DE RETENÇÃO DE CHARNEIRA – SÉRIE LIGEIRA

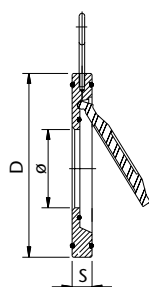

DN	S mm.	D mm.	Ø mm.	PESO Kg.	COD.	€
40	14	94	22	0,8	VF540040	69,55
50	14	107	32	1,0	VF540050	73,15
65	14	127	40	1,5	VF540065	90,05
80	14	142	54	2,0	VF540080	116,65
100	18	162	70	2,5	VF540100	165,25
125	18	192	92	3,5	VF540125	212,25
150	20	218	114	4,5	VF540150	277,45
200	22	273	154	7,5	VF540200	515,90
250	26	329	200	12,0	VF540250	772,05
300	28	384	235	17,5	VF540300	1.057,75

CARACTERÍSTICAS TÉCNICAS

Pressão de serviço: PN 16.
Temperatura de serviço: -10° C a 150° C .
Para flanges DIN EN 1092 PN16.

COMPONENTES

Corpo: Aço Inoxidável AISI 316
Disco: Aço Inoxidável AISI 316
Assento da charneira: Viton
Assento da flange: Viton
Fixação: Aço Inoxidável AISI 316



VÁLVULA DE ESFERA 2 CORPOS PASSAGEM TOTAL COM PLACA – ROSCADA

Corpo em aço inoxidável CF8M (AISI316).
Eixo em AISI 316.
Manípulo em AISI 304 revestido a PVC azul.
Assento da esfera PTFE +15% GF.
Extremos rosca ISO 7/1 (rosca R-Rp).
Temperatura de serviço: -10° C a 150° C.
Pressão de serviço: 1000 WOG/PN 63.
Sistema de bloqueio.
Montagem de atuador direto conforme ISO 5211.

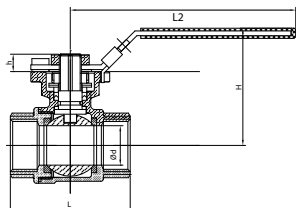

Ø	d mm.	L mm.	L2 mm.	H mm.	h mm.		COD.	€	
1/4"	9,0	48,0	120,5	37,0	9	60	1	IVB2P061	19,60
3/8"	12,5	48,0	120,5	39,0	9	60	1	IVB2P062	19,60
1/2"	15,0	56,0	120,5	39,0	9	45	1	IVB2P063	22,20
3/4"	20,0	64,0	120,5	41,5	9	25	1	IVB2P064	31,70
1"	25,0	76,0	140,0	47,0	11	16	1	IVB2P065	42,00
1 1/4"	32,0	86,5	140,0	52,0	11	10	1	IVB2P066	62,10
1 1/2"	38,0	97,5	170,0	62,0	14	6	1	IVB2P067	79,35
2"	50,0	117,5	170,0	71,0	14	4	1	IVB2P068	122,80



VÁLVULA DE ESFERA TRÊS CORPOS PASSAGEM TOTAL COM PLACA – ROSCADA

Corpo em aço inoxidável CF8M (AISI 316).
Eixo em AISI 316.
Manípulo em AISI 304 revestido a PVC azul.
Assento da esfera PTFE +15% GF.
Extremos roscados ISO 7/1 (Rosca R-RP).
Temperatura de serviço: -20° C a 180° C.
Pressão de serviço: 1000 WOG/PN 63.
Sistema de bloqueio.
Montagem de atuador direto conforme ISO 5211.

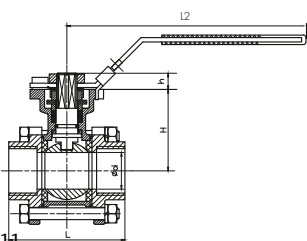

Ø	d mm.	L mm.	L2 mm.	H mm.	h mm.		COD.	€	
1/2"	15	61	120,5	39,0	9	30	1	IVB3P063	30,55
3/4"	20	69	120,5	41,5	9	16	1	IVB3P064	41,75
1"	25	79	140,0	47,0	11	11	1	IVB3P065	50,30
1 1/4"	32	96	140,0	52,0	11	6	1	IVB3P066	83,40
1 1/2"	38	102	170,0	62,0	14	4	1	IVB3P067	107,10
2"	50	124	170,0	71,0	14	2	1	IVB3P068	154,15
2 1/2"	65	158	230,0	89,0	18	2	1	IVB3P069	375,90
3"	76	179	230,0	98,0	18	1	1	IVB3P06A	538,20
4"	94	220	300,0	129,0	22	1	1	IVB3P06C	815,20



VÁLVULA DE ESFERA TRÊS CORPOS PASSAGEM TOTAL COM PLACA – BUTT WELD

Corpo em aço inoxidável CF8M (AISI 316).
Eixo em AISI 316.
Manípulo em AISI 304 revestido a PVC azul.
Assento da esfera em PTFE +15% GF.
Temperatura de serviço: -20° C a 180° C.
Pressão de serviço: 1000 WOG/PN 63.
Sistema de bloqueio.
Montagem de atuador direto conforme ISO 5211.
Extremos para soldar Butt Weld ANSI B 16.25.

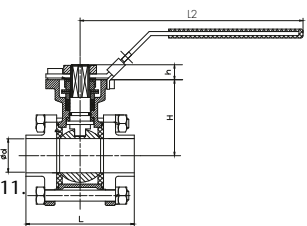

Ø	d mm.	L mm.	L2 mm.	H mm.	h mm.		COD.	€	
1/2"	15	61	120,5	39,0	9	30	1	IVB3PB63	30,55
3/4"	20	69	120,5	41,5	9	16	1	IVB3PB64	41,75
1"	25	79	140,0	47,0	11	11	1	IVB3PB65	50,30
1 1/4"	32	96	140,0	52,0	11	6	1	IVB3PB66	83,40
1 1/2"	38	102	170,0	62,0	14	4	1	IVB3PB67	107,10
2"	50	124	170,0	71,0	14	2	1	IVB3PB68	154,15
2 1/2"	65	158	230,0	89,0	18	2	1	IVB3PB69	375,90
3"	76	179	230,0	98,0	18	1	1	IVB3PB6A	538,20
4"	94	220	300,0	129,0	22	1	1	IVB3PB6C	815,20



VÁLVULA DE ESFERA TRÊS CORPOS PASSAGEM TOTAL COM PLACA – SOCKET WELD

Corpo em aço inoxidável CF8M (AISI 316).
Eixo em AISI 316.
Manípulo em AISI 304 revestido a PVC azul.
Assento da esfera em PTFE +15% GF.
Temperatura de serviço: -20° C a 180° C.
Pressão de serviço: 1000 WOG/PN 63.
Sistema de bloqueio.
Montagem de atuador direto conforme ISO 5211.
Extremos para soldar Socket Weld ANSI B 16.11.

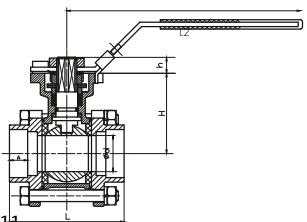

Ø	d mm.	L mm.	L2 mm.	H mm.	h mm.		COD.	€	
1/2"	15	61	120,5	39,0	9	30	1	IVB3PS63	30,55
3/4"	20	69	120,5	41,5	9	16	1	IVB3PS64	41,75
1"	25	79	140,0	47,0	11	11	1	IVB3PS65	50,30
1 1/4"	32	96	140,0	52,0	11	6	1	IVB3PS66	83,40
1 1/2"	38	102	170,0	62,0	14	4	1	IVB3PS67	107,10
2"	50	124	170,0	71,0	14	2	1	IVB3PS68	154,15
2 1/2"	65	158	230,0	89,0	18	2	1	IVB3PS69	375,90
3"	76	179	230,0	98,0	18	1	1	IVB3PS6A	538,20
4"	94	220	300,0	129,0	22	1	1	IVB3PS6C	815,20

VÁLVULA DE ESFERA 3 VIAS PASSAGEM EM "T" OU "L"



Ø	DN	L1 ±2 mm.	Ø D mm.	H mm.	W mm.	ISO 5211		COD. TIPO "T"	COD. TIPO "L"	€
1/4"	8	64	9,0	76	143	F04/03	15 1	IVBT0061	IVBL0061	68,70
3/8"	10	64	11,0	76	143	F04/03	15 1	IVBT0062	IVBL0062	68,70
1/2"	15	64	12,5	76	143	F04/03	13 1	IVBT0063	IVBL0063	69,90
3/4"	20	68	16,0	80	143	F04/03	7 1	IVBT0064	IVBL0064	83,50
1"	25	82	20,0	95	163	F05/04	5 1	IVBT0065	IVBL0065	117,55
1 1/4"	32	90	25,0	98	163	F05/04	4 1	IVBT0066	IVBL0066	180,75
1 1/2"	40	107	32,0	110	188	F07/05	3 1	IVBT0067	IVBL0067	249,45
2"	50	124	38,0	119	188	F07/05	2 1	IVBT0068	IVBL0068	392,20

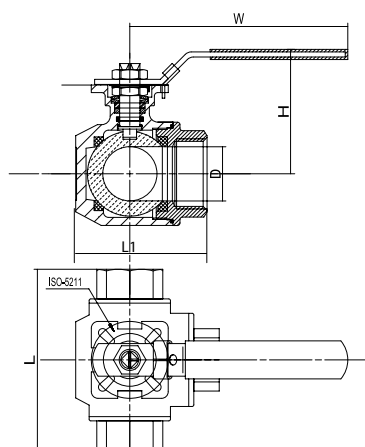

CARACTERÍSTICAS TÉCNICAS

Pressão de serviço: PN 63.
 Temperatura de serviço: -20° C a 180° C.
 Montagem de atuador direto conforme ISO 5211.
 Extremos rosca ISO 7/1 (rosca R-Rp).

COMPONENTES

Corpo: Aço inoxidável CF8M (AISI 316)
Junta: PTFE+15% GF
Junta do eixo: Viton
Eixo: AISI 316
Manípulo: AISI 304 revestido a PVC azul
Bola: AISI 316

VÁLVULA DE ESFERA 2 CORPOS PASSAGEM TOTAL FLANGEADA



Ø	DN	L mm.	Ø d mm.	Ø D mm.	H mm.	W mm.	ISO 5211		COD.	€
1/2"	15	115	15	95	76	110	F03-F04	1	IVB20015	130,50
3/4"	20	120	20	105	81	110	F03-F04	1	IVB20020	166,70
1"	25	125	25	115	90	140	F04-F05	1	IVB20025	201,60
1 1/4"	32	130	32	140	102	140	F04-F05	1	IVB20032	288,55
1 1/2"	40	140	38	150	114	185	F05-F07	1	IVB20040	329,60
2"	50	150	50	165	122	185	F05-F07	1	IVB20050	434,00
2 1/2"	65	170	65	185	168	305	F07-F10	1	IVB20B65	627,55
3"	80	180	78	200	178	305	F07-F10	1	IVB20080	994,65
4"	100	190	100	220	198	305	F07-F10	1	IVB20100	1.457,50
5"	125	325	125	250	234	500	F10-F12	1	IVB20125	2.312,80
6"	150	350	150	285	250	645	F10-F12	1	IVB20150	3.233,05

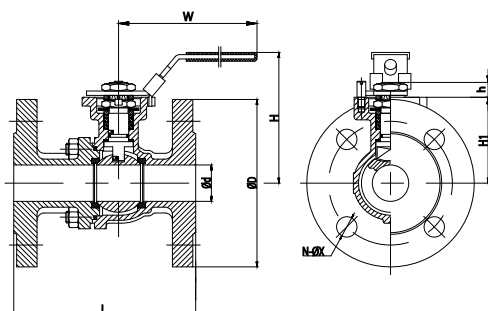

CARACTERÍSTICAS TÉCNICAS

Pressão de serviço: PN 40 de DN15 a DN40; PN 16 de DN50 a DN150.
 Temperatura de serviço: -30° C a 180° C.
 Flanges DIN 2635 de DN15 a DN40; DIN 2633 de DN50 a DN150.
 Distância entre faces conforme DIN 3202-F4.
 Fire Safe API607.
 Dispositivo anti estático.
 Montagem de atuador direto conforme ISO 5211
 Certificado ATEX segundo a directiva 2014/34/EU.

COMPONENTES

Corpo: Aço inoxidável CF8M (AISI 316)
Junta: PTFE+15%GF
Junta do eixo: Viton
Eixo: AISI 316
Manípulo: A276 201 revestido a PVC azul.
Bola: AISI 316

VÁLVULA DE RETENÇÃO ROSCADA PN 63

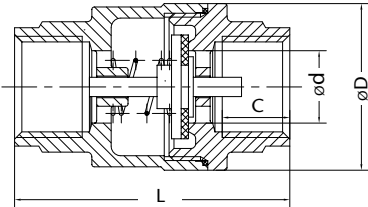

Ø	Ø d mm.	Ø D mm.	C mm.	L mm.	COD.	€
1/4"	10,5	30,0	12	54	IV130601	17,75
3/8"	13,0	30,0	12	54	IV130602	17,75
1/2"	15,0	34,5	14	57	IV130603	18,00
3/4"	20,0	41,5	15	64	IV130604	24,40
1"	25,0	48,6	18	80	IV130605	31,70
1 1/4"	32,0	60,5	17	82	IV130606	46,75
1 1/2"	40,0	71,0	18	93	IV130607	59,60
2"	50,0	87,0	17	100	IV130608	84,80

CARACTERÍSTICAS TÉCNICAS

Pressão de serviço: PN 63.

Extremos roscados conforme ISO 7/1.

Temperatura de serviço: -30° C a 150° C.

Instalação em qualquer posição desde que respeitando o sentido do fluido indicado pela seta.

COMPONENTES

Corpo: CF8M (AISI 316)

Mola: AISI 316

Disco: CF8M (AISI 316)

Vedante do disco: Viton

Tampão: CF8M (AISI 316)

Vedante: PTFE

VÁLVULA RETENÇÃO DE DISCO TIPO WAFER PN 63

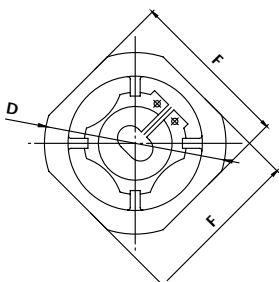
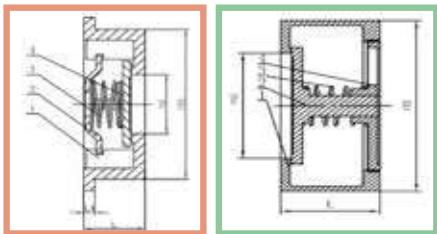

Ø	DN	Ø D mm.	F mm.	Ø D1 mm.	L1	L mm.	COD.	€
1/2"	15	53	46	43	4	16,5	IV566015	13,60
3/4"	20	63	55	53	5	19,5	IV566020	15,60
1"	25	73	65	63	4	22,0	IV566025	19,85
1 1/4"	32	84	78	75	6	28,0	IV566032	31,00
1 1/2"	40	94	88	86	6	32,0	IV566040	43,30
2"	50	107	98	94	7	40,0	IV566050	59,10
2 1/2"	65	126	118	115	7	46,0	IV566065	88,20
3"	80	144	134	130	8	50,0	IV566080	127,10
4"	100	164	154	152	9	60,0	IV566100	190,85
5"	125	190				82,0	IV566125	381,75
6"	150	217				102,0	IV566150	536,05

CARACTERÍSTICAS TÉCNICAS

Pressão de serviço: PN 63.

Temperatura de serviço: -20° C a 425° C.

Aplicações: Indústria química, alimentar, térmica e farmacêutica.

Aptas para: Água, gás, vapor, condensados, óleos e ácidos.

Instalação em qualquer posição desde que respeitando o sentido do fluido indicado pela seta.

Distância entre faces conforme EN 558 série 49 (salvo DN125 e 150).

COMPONENTES

Corpo: CF8M (AISI 316)

Suporte da mola: AISI 304

Mola: AISI 304

Disco: CF8M (AISI 316)

ACESSÓRIOS PARA SOLDAR - ISO



CURVA 90° 3D DE TUBO SOLDADO

Ø	Ø mm.	DN	AISI 304L ESP. 2 mm.		AISI 316L ESP. 2 mm.		AISI 316L ESP. 3 mm.	
			COD.	€	COD.	€	COD.	€
1/2"	21,3	15	IC934203	4,00	IC936203	4,30		
3/4"	26,9	20	IC934204	4,00	IC936204	4,30		
1"	33,7	25	IC934205	4,15	IC936205	5,30	IC936305	8,05
1 1/4"	42,4	32	IC934206	5,30	IC936206	6,55	IC936306	9,15
1 1/2"	48,3	40	IC934207	6,20	IC936207	7,80	IC936307	10,80
2"	60,3	50	IC934208	8,70	IC936208	11,30	IC936308	14,85
2 1/2"	76,1	65	IC934209	16,60	IC936209	20,15	IC936309	26,85
3"	88,9	80	IC93420A	19,00	IC93620A	28,25	IC93630A	34,50
4"	114,3	100	IC93420C	28,15	IC93620C	37,30	IC93630C	55,15
5"	139,7	125	IC93420D	64,15	IC93620D	89,50	IC93630D	115,55
6"	168,3	150	IC93420E	75,50	IC93620E	101,45	IC93630E	130,15
8"	219,1	200	IC93420F	133,35	IC93620F	171,85		
10"	273,0	250	IC93420G	289,90	IC93620G	393,10		
12"	323,9	300	IC93420H	426,20	IC93620H	693,15		



TE

Ø	Ø mm.	DN	AISI 304L ESP. 2 mm.		AISI 316L ESP. 2 mm.	
			COD.	€	COD.	€
1/2"	21,3	15	IT104203	9,35	IT106203	11,20
3/4"	26,9	20	IT104204	10,00	IT106204	11,90
1"	33,7	25	IT104205	10,85	IT106205	12,75
1 1/4"	42,4	32	IT104206	12,40	IT106206	14,10
1 1/2"	48,3	40	IT104207	13,30	IT106207	15,35
2"	60,3	50	IT104208	21,65	IT106208	23,50
2 1/2"	76,1	65	IT104209	27,60	IT106209	30,50
3"	88,9	80	IT10420A	40,45	IT10620A	46,05
4"	114,3	100	IT10420C	82,45	IT10620C	57,55
5"	139,7	125	IT10420D	96,10	IT10620D	118,05
6"	168,3	150	IT10420E	125,55	IT10620E	149,30
8"	219,1	200	IT10420F	211,30	IT10620F	255,60
10"	273,0	250	IT10420G	417,05	IT10620G	534,20
12"	323,9	300	IT10420H	752,75	IT10620H	943,80



TAMPÃO

Ø	Ø mm.	DN	AISI 304L ESP. 2 mm.		AISI 316L ESP. 2 mm.	
			COD.	€	COD.	€
1/2"	21,3	15	ICA04203	2,05	ICA06203	2,40
3/4"	26,9	20	ICA04204	2,10	ICA06204	2,55
1"	33,7	25	ICA04205	2,45	ICA06205	2,95
1 1/4"	42,4	32	ICA04206	3,25	ICA06206	4,15
1 1/2"	48,3	40	ICA04207	3,70	ICA06207	4,90
2"	60,3	50	ICA04208	4,40	ICA06208	7,40
2 1/2"	76,1	65	ICA04209	6,50	ICA06209	9,35
3"	88,9	80	ICA0420A	8,20	ICA0620A	12,15
4"	114,3	100	ICA0420C	11,65	ICA0620C	16,20
5"	139,7	125	ICA0420D	16,00	ICA0620D	24,05
6"	168,3	150	ICA0420E	22,50	ICA0620E	34,75
8"	219,1	200	ICA0420F	28,80	ICA0620F	43,65
10"	273,0	250	ICA0420G	37,60	ICA0620G	62,05
12"	323,9	300	ICA0420H	45,15	ICA0620H	74,45

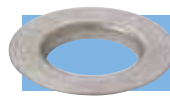

ADAPTADOR PARA FLANGE VALONA

Ø	Ø mm.	DN	AISI 304L ESP. 2 mm.		AISI 316L ESP. 2 mm.	
			COD.	€	COD.	€
1/2"	21,3	15	ICT04203	1,10	ICT06203	1,60
3/4"	26,9	20	ICT04204	1,60	ICT06204	1,95
1"	33,7	25	ICT04205	2,10	ICT06205	2,30
1 1/4"	42,4	32	ICT04206	2,70	ICT06206	4,05
1 1/2"	48,3	40	ICT04207	3,35	ICT06207	4,45
2"	60,3	50	ICT04208	4,15	ICT06208	6,15
2 1/2"	76,1	65	ICT04209	5,60	ICT06209	8,15
3"	88,9	80	ICT0420A	6,40	ICT0620A	8,55
4"	114,3	100	ICT0420C	8,15	ICT0620C	11,20
5"	139,7	125	ICT0420D	10,15	ICT0620D	14,95
6"	168,3	150	ICT0420E	11,65	ICT0620E	17,20
8"	219,1	200	ICT0420F	18,60	ICT0620F	28,05
10"	273,0	250	ICT0420G	19,05	ICT0620G	31,70
12"	323,9	300	ICT0420H	21,60	ICT0620H	32,50



REDUÇÃO CONCÊNTRICA

Ø	Ø mm.	DN	ALTURA mm.	AISI 304L ESP. 2 mm.		AISI 316L ESP. 2 mm.	
				COD.	€	COD.	€
3/4" x 1/2"	26,9 x 21,3	20 x 15	38	IRC04243	4,50	IRC06243	5,60
1" x 1/2"	33,7 x 21,3	25 x 15	51	IRC04253	5,10	IRC06253	6,20
1" x 3/4"	33,7 x 26,9	25 x 20	51	IRC04254	4,50	IRC06254	6,55
1 1/4" x 1"	42,4 x 33,7	32 x 25	51	IRC04265	6,15	IRC06265	6,50
1 1/2" x 1/2"	48,3 x 21,3	40 x 15	64	IRC04273	13,95	IRC06273	18,05
1 1/2" x 1"	48,3 x 33,7	40 x 25	64	IRC04275	8,05	IRC06275	10,55
1 1/2" x 1 1/4"	48,3 x 42,4	40 x 32	64	IRC04276	7,00	IRC06276	8,60
2" x 1/2"	60,3 x 21,3	50 x 15	76	IRC04283	22,85	IRC06283	29,15
2" x 3/4"	60,3 x 26,9	50 x 20	76	IRC04284	19,25	IRC06284	22,25
2" x 1"	60,3 x 33,7	50 x 25	76	IRC04285	10,95	IRC06285	12,60
2" x 1 1/4"	60,3 x 42,4	50 x 32	76	IRC04286	10,55	IRC06286	10,95
2" x 1 1/2"	60,3 x 48,3	50 x 40	76	IRC04287	10,15	IRC06287	10,40
2 1/2" x 1 1/2"	76,1 x 48,3	65 x 40	89	IRC04297	11,15	IRC06297	16,60
2 1/2" x 2"	76,1 x 60,3	65 x 50	89	IRC04298	10,70	IRC06298	13,00
3" x 1"	88,9 x 33,7	80 x 25	89	IRC042A5	24,30	IRC062A5	45,40
3" x 1 1/2"	88,9 x 48,3	80 x 40	89	IRC042A7	18,25	IRC062A7	21,00
3" x 2"	88,9 x 60,3	80 x 50	89	IRC042A8	17,70	IRC062A8	17,95
3" x 2 1/2"	88,9 x 76,1	80 x 65	89	IRC042A9	14,35	IRC062A9	20,35
4" x 1 1/2"	114,3 x 48,3	100 x 40	102	IRC042C7	19,80	IRC062C7	45,30
4" x 2"	114,3 x 60,3	100 x 50	102	IRC042C8	18,40	IRC062C8	23,20
4" x 2 1/2"	114,3 x 76,1	100 x 65	102	IRC042C9	17,00	IRC062C9	37,15
4" x 3"	114,3 x 88,9	100 x 80	102	IRC042CA	16,50	IRC062CA	18,65
5" x 3"	139,7 x 88,9	125 x 80	127	IRC042DA	33,35	IRC062DA	51,80
5" x 4"	139,7 x 114,3	125 x 100	127	IRC042DC	32,65	IRC062DC	40,75
6" x 4"	168,3 x 114,3	150 x 100	140	IRC042EC	44,85	IRC062EC	53,05
6" x 5"	168,3 x 139,7	150 x 125	140	IRC042ED	42,95	IRC062ED	47,80
8" x 3"	219,1 x 88,9	200 x 80	152			IRC062FA	155,15
8" x 4"	219,1 x 114,3	200 x 100	152	IRC042FC	88,60	IRC062FC	121,55
8" x 5"	219,1 x 139,7	200 x 125	152	IRC042FD	71,95	IRC062FD	110,30
8" x 6"	219,1 x 168,3	200 x 150	152	IRC042FE	64,00	IRC062FE	83,10
10" x 6"	273,0 x 168,3	250 x 150	178	IRC042GE	186,30	IRC062GE	199,50
10" x 8"	273,0 x 219,1	250 x 200	178	IRC042GF	150,25	IRC062GF	169,25
12" x 8"	323,9 x 219,1	300 x 200	203	IRC042HF	289,15	IRC062HF	314,25
12" x 10"	323,9 x 273,0	300 x 250	203	IRC042HG	194,40	IRC062HG	298,55

ACESSÓRIOS PARA SOLDAR - MILIMÉTRICO

CURVA 90° 3D DE TUBO SOLDADO

Ø	Ø mm.	DN	R mm.	ESP. mm.	AISI 304L		AISI 316L	
					COD.	€	COD.	€
1/2"	18,0	15	25,0	1,5	IC341018	3,55	IC361018	4,15
1/2"	20,0	15	30,0	1,5	IC341020	3,90	IC361020	4,30
3/4"	23,0	20	35,0	1,5	IC341023	3,90		
3/4"	25,0	20	37,0	1,5	IC341025	3,95	IC361025	6,20
3/4"	28,0	20	40,0	1,5	IC341028	4,20	IC361028	6,45
3/4"	30,0	20	45,0	1,5	IC341030	4,50	IC361030	6,55
1"	33,0	25	50,0	1,5	IC341033	4,55	IC361033	6,70
1 1/4"	35,0	32	52,5	1,5	IC341035	4,75		
1 1/4"	38,0	32	55,0	1,5	IC341038	5,00		
1 1/2"	40,0	40	60,0	1,5	IC341040	5,65	IC361040	8,70
1 1/2"	43,0	40	65,0	1,5	IC341043	5,80	IC361043	8,75
2"	50,8	50	76,0	1,5	IC341051	7,00	IC361050	11,70
2"	53,0	50	80,0	1,5	IC341053	7,60	IC361053	12,35
2"	63,5	50	95,0	1,5	IC341063	13,00	IC361063	16,05
2"	54,0	50	80,0	2,0	IC342054	9,55		
2"	57,0	50	85,5	2,0	IC342057	11,15		
2 1/2"	70,0	65	92,0	2,0	IC342070	13,70	IC362070	22,30
2 1/2"	73,0	65	110,0	1,5	IC341073	17,70	IC361073	26,25
2 1/2"	76,0	65	115,0	1,5	IC341076	17,70	IC361076	26,45
3"	84,0	80	125,0	2,0	IC342084	20,50	IC362084	36,05
4"	104,0	100	155,0	2,0	IC342104	29,50	IC362104	44,95
5"	129,0	125	190,0	2,0	IC342129	56,10	IC362129	87,05
6"	154,0	150	225,0	2,0	IC342154	87,00	IC362154	95,35
8"	204,0	200	300,0	2,0	IC342204	133,35	IC362204	189,10
10"	254,0	250	380,0	2,0	IC342254	305,05		

TÊ

Ø mm.	DN	ESP. mm.	AISI 304L		AISI 316L	
			COD.	€	COD.	€
25,0	20	1,5	ITM41025	12,15	ITM61025	14,00
28,0	20	1,5	ITM41028	12,15	ITM61028	14,25
33,0	25	1,5	ITM41033	13,55	ITM61033	16,10
43,0	40	1,5	ITM41043	16,75	ITM61043	19,25
50,8	50	1,5	ITM41050	18,40	ITM61050	21,05
53,0	50	1,5	ITM41053	18,70	ITM61053	23,75
63,5	50	1,5	ITM41063	30,55	ITM61063	34,60
73,0	65	1,5	ITM41073	38,00	ITM61073	43,05
84,0	80	2,0	ITM42084	38,40	ITM62084	53,10
104,0	100	2,0	ITM42104	55,95	ITM62104	75,60
129,0	125	2,0	ITM42129	113,00	ITM62129	135,35
154,0	150	2,0	ITM42154	153,70	ITM62154	189,90
204,0	200	2,0	ITM42204	280,45	ITM62204	331,80
254,0	250	2,0	ITM42254	516,00	ITM62254	653,50
304,0	300	2,0			ITM62304	984,40
354,0	300	2,0			ITM62354	1.374,80

TAMPÃO

Ø mm.	DN	ESP. mm.	AISI 304L		AISI 316L	
			COD.	€	COD.	€
25,0	20	1,5	ICAM4025	2,25	ICAM6025	3,10
28,0	20	1,5	ICAM4028	2,35	ICAM6028	3,30
33,0	25	1,5	ICAM4033	2,55	ICAM6033	3,45
43,0	40	1,5	ICAM4043	3,25	ICAM6043	4,75
50,8	50	1,5	ICAM4050	4,00	ICAM6050	5,80
53,0	50	1,5	ICAM4053	4,05	ICAM6053	5,90
63,5	50	1,5	ICAM4063	5,20	ICAM6063	7,60
70,0	65	2,0	ICAM4070	5,50	ICAM6070	7,80
73,0	65	1,5	ICAM4073	5,80	ICAM6073	8,75
84,0	80	2,0	ICAM4084	6,95	ICAM6084	9,55
104,0	100	2,0	ICAM4104	10,10	ICAM6104	11,95
129,0	125	2,0	ICAM4129	12,75	ICAM6129	17,20
154,0	150	2,0	ICAM4154	20,10	ICAM6154	24,10
204,0	200	2,0	ICAM4204	32,25	ICAM6204	41,20
254,0	250	2,0	ICAM4254	48,15	ICAM6254	65,75
304,0	300	2,0	ICAM4304	64,80	ICAM6304	82,50
354,0	300	2,0	ICAM4354	112,45	ICAM6354	145,60



ADAPTADOR PARA FLANGE VALONA

Ø	DN	ESP. mm.	AISI 304L		AISI 316L	
			COD.	€	COD.	€
25,0	20	1,5	ICM41025	1,65	ICM61025	2,15
28,0	20	1,5	ICM41028	1,90	ICM61028	2,70
33,0	25	1,5	ICM41033	2,15	ICM61033	3,10
43,0	40	1,5	ICM41043	2,95	ICM61043	4,30
50,8	50	1,5	ICM41050	4,00	ICM61050	5,35
53,0	50	1,5	ICM41053	4,05	ICM61053	5,35
63,5	50	1,5	ICM41063	4,50	ICM61063	6,55
70,0	65	2,0	ICM42070	5,10	ICM62070	7,10
73,0	65	1,5	ICM41073	5,25	ICM61073	7,55
84,0	80	2,0	ICM42084	6,40	ICM62084	9,00
104,0	100	2,0	ICM42104	8,10	ICM62104	11,95
129,0	125	2,0	ICM42129	10,75	ICM62129	14,05
154,0	150	2,0	ICM42154	12,00	ICM62154	17,00
204,0	200	2,0	ICM42204	18,80	ICM62204	26,95
254,0	250	2,0	ICM42254	25,65	ICM62254	33,75
304,0	300	2,0	ICM42304	30,55	ICM62304	41,75
354,0	300	2,0	ICM42354	42,20	ICM62354	58,00



REDUÇÃO CONCÊNTRICA

Ø mm.	DN	ESP. mm.	AISI 304L		AISI 316L	
			COD.	€	COD.	€
53,0 x 43,0	50 x 40	1,5	IRM45343	10,70	IRM65343	19,65
63,5 x 43,0	50 x 40	1,5	IRM46343	15,80	IRM66343	16,80
63,5 x 53,0	50 x 50	1,5	IRM46353	13,75	IRM66353	14,55
73,0 x 43,0	65 x 40	2,0	IRM47343	17,70	IRM67343	28,05
73,0 x 53,0	65 x 50	2,0	IRM47353	17,00	IRM67353	24,10
73,0 x 63,5	65 x 50	2,0	IRM47363	17,05	IRM67363	21,00
84,0 x 43,0	80 x 40	2,0	IRM48443	30,75	IRM68443	26,60
84,0 x 53,0	80 x 50	2,0	IRM48453	18,80	IRM68453	24,60
84,0 x 63,5	80 x 50	2,0	IRM48463	18,55	IRM68463	22,40
84,0 x 73,0	80 x 65	2,0	IRM48473	18,55	IRM68473	19,65
104,0 x 43,0	100 x 40	2,0	IRM41043	60,55	IRM61043	47,55
104,0 x 53,0	100 x 50	2,0	IRM41053	33,40	IRM61053	38,60
104,0 x 63,5	100 x 50	2,0	IRM41063	32,20	IRM61063	34,50
104,0 x 73,0	100 x 65	2,0	IRM41073	26,70	IRM61073	31,30
104,0 x 84,0	100 x 80	2,0	IRM41084	26,85	IRM61084	28,65
129,0 x 73,0	125 x 65	2,0	IRM41273	43,35	IRM61273	51,30
129,0 x 84,0	125 x 80	2,0	IRM41284	63,15	IRM61284	62,25
129,0 x 104,0	125 x 100	2,0	IRM41210	44,40	IRM61210	51,55
154,0 x 73,0	150 x 65	2,0	IRM41573	84,40	IRM61573	111,20
154,0 x 84,0	150 x 80	2,0	IRM41584	80,50	IRM61584	83,40
154,0 x 104,0	150 x 100	2,0	IRM41510	47,40	IRM61510	65,90
154,0 x 129,0	150 x 125	2,0	IRM41512	46,75	IRM61512	63,60
204,0 x 104,0	200 x 100	2,0	IRM42010	115,30	IRM62010	139,60
204,0 x 129,0	200 x 125	2,0	IRM42012	87,75	IRM62012	120,35
204,0 x 154,0	200 x 150	2,0	IRM42015	76,15	IRM62015	102,40

ACESSÓRIOS PARA SOLDAR - NORMA ASTM - SCH 10S FABRICADO TUBO SOLDADO



CURVA 90° RAI0 LONGO

Ø	Ø EXT mm.	ESP.	AISI 304L		AISI 316L	
			COD.	€	COD.	€
1/2"	21,3	2,11	I1CL940M	3,90	I1CL960M	4,75
3/4"	26,7	2,11	I1CL940T	5,00	I1CL960T	6,20
1"	33,4	2,77	I1CL9401	5,40	I1CL9601	6,75
1 1/4"	42,2	2,77	I1CL941C	6,55	I1CL961C	8,05
1 1/2"	48,3	2,77	I1CL941M	9,30	I1CL961M	11,55
2"	60,3	2,77	I1CL9402	12,35	I1CL9602	15,60
2 1/2"	73,0	3,05	I1CL942M	17,50	I1CL962M	21,90
3"	88,9	3,05	I1CL9403	27,20	I1CL9603	35,35
4"	114,3	3,05	I1CL9404	47,05	I1CL9604	60,35
5"	141,3	3,40	I1CL9405	87,10	I1CL9605	112,05
6"	168,3	3,40	I1CL9406	120,80	I1CL9606	155,65
8"	219,1	3,76	I1CL9408	217,65	I1CL9608	276,30
10"	273,0	4,19	I1CL9410	469,50	I1CL9610	601,75



TÉ

Ø	Ø EXT mm.	ESP.	AISI 304L		AISI 316L	
			COD.	€	COD.	€
1/2"	21,3	2,11	I1T4000M	9,25	I1T6000M	12,40
3/4"	26,7	2,11	I1T4000T	9,75	I1T6000T	12,70
1"	33,4	2,77	I1T40001	10,30	I1T60001	12,90
1 1/4"	42,2	2,77	I1T4001C	14,05	I1T6001C	17,60
1 1/2"	48,3	2,77	I1T4001M	20,35	I1T6001M	25,30
2"	60,3	2,77	I1T40002	24,15	I1T60002	30,05
2 1/2"	73,0	3,05	I1T4002M	41,75	I1T6002M	51,60
3"	88,9	3,05	I1T40003	48,75	I1T60003	61,25
4"	114,3	3,05	I1T40004	78,95	I1T60004	98,00
5"	141,3	3,40	I1T40005	142,70	I1T60005	174,15
6"	168,3	3,40	I1T40006	176,80	I1T60006	219,20
8"	219,1	3,76	I1T40008	394,90	I1T60008	484,95



TAMPÃO

Ø	Ø EXT mm.	ESP.	AISI 304L		AISI 316L	
			COD.	€	COD.	€
1/2"	21,3	2,11	I1CC400M	4,45	I1CC600M	6,20
3/4"	26,7	2,11	I1CC400T	5,35	I1CC600T	7,45
1"	33,4	2,77	I1CC4001	6,65	I1CC6001	9,20
1 1/4"	42,2	2,77	I1CC401C	7,55	I1CC601C	10,60
1 1/2"	48,3	2,77	I1CC401M	8,45	I1CC601M	12,05
2"	60,3	2,77	I1CC4002	8,80	I1CC6002	12,50
2 1/2"	73,0	3,05	I1CC402M	11,85	I1CC602M	16,25
3"	88,9	3,05	I1CC4003	17,75	I1CC6003	24,40
4"	114,3	3,05	I1CC4004	25,95	I1CC6004	36,90
5"	141,3	3,40	I1CC4005	43,60	I1CC6005	61,20
6"	168,3	3,40	I1CC4006	54,50	I1CC6006	77,35
8"	219,1	3,76	I1CC4008	88,55	I1CC6008	129,45



COLARINHO

Ø	Ø EXT mm.	ESP.	AISI 304L		AISI 316L	
			COD.	€	COD.	€
1/2"	21,3	2,11	I1SE400M	9,70	I1SE600M	13,85
3/4"	26,7	2,11	I1SE400T	10,40	I1SE600T	14,85
1"	33,4	2,77	I1SE4001	12,55	I1SE6001	15,95
1 1/4"	42,2	2,77	I1SE401C	13,35	I1SE601C	18,15
1 1/2"	48,3	2,77	I1SE401M	14,55	I1SE601M	20,35
2"	60,3	2,77	I1SE4002	21,10	I1SE6002	29,40
2 1/2"	73,0	3,05	I1SE402M	23,40	I1SE602M	32,15
3"	88,9	3,05	I1SE4003	31,55	I1SE6003	43,45
4"	114,3	3,05	I1SE4004	47,15	I1SE6004	64,45
5"	141,3	3,40	I1SE4005	68,00	I1SE6005	94,85
6"	168,3	3,40	I1SE4006	104,75	I1SE6006	142,70
8"	219,1	3,76	I1SE4008	170,65	I1SE6008	242,20
10"	273,0	4,19	I1SE4010	337,65	I1SE6010	472,65



REDUÇÃO CONCÊNTRICA

Ø	Ø EXT mm.	AISI 304L		AISI 316L	
		COD.	€	COD.	€
3/4" x 1/2"	26,7 x 21,3	I1R40T0M	3,80	I1R60T0M	4,85
1" x 1/2"	33,4 x 21,3	I1R4010M	4,25	I1R6010M	5,40
1" x 3/4"	33,4 x 26,7	I1R4010T	3,90	I1R6010T	4,95
1 1/4" x 3/4"	42,2 x 26,7	I1R41C0T	6,75	I1R61C0T	8,75
1 1/4" x 1"	42,2 x 33,4	I1R41C01	6,10	I1R61C01	7,80
1 1/2" x 3/4"	48,3 x 26,7	I1R41M0T	8,30	I1R61M0T	10,50
1 1/2" x 1"	48,3 x 33,4	I1R41M01	7,45	I1R61M01	9,70
1 1/2" x 1 1/4"	48,3 x 42,2	I1R41M1C	7,40	I1R61M1C	9,35
2" x 1"	60,3 x 33,4	I1R40201	8,95	I1R60201	11,55
2" x 1 1/4"	60,3 x 42,2	I1R4021C	8,30	I1R6021C	10,50
2" x 1 1/2"	60,3 x 48,3	I1R4021M	8,00	I1R6021M	10,25
2 1/2" x 1 1/2"	73,0 x 48,3	I1R42M1M	16,75	I1R62M1M	21,20
2 1/2" x 2"	73,0 x 60,3	I1R42M02	16,15	I1R62M02	20,80
3" x 1 1/2"	88,9 x 48,3	I1R4031M	14,25	I1R6031M	18,80
3" x 2"	88,9 x 60,3	I1R40302	15,75	I1R60302	20,30
3" x 2 1/2"	88,9 x 73,0	I1R4032M	13,55	I1R6032M	18,00
4" x 2"	114,3 x 60,3	I1R40402	24,00	I1R60402	30,90
4" x 2 1/2"	114,3 x 73,0	I1R4042M	21,00	I1R6042M	27,90
4" x 3"	114,3 x 88,9	I1R40403	22,30	I1R60403	28,80
5" x 3"	141,3 x 88,9	I1R40503	54,85	I1R60503	69,35
5" x 4"	141,3 x 114,3	I1R40504	52,85	I1R60504	67,25
6" x 3"	168,3 x 88,9	I1R40603	74,85	I1R60603	97,00
6" x 4"	168,3 x 114,3	I1R40604	66,75	I1R60604	84,35
6" x 5"	168,3 x 141,3	I1R40605	63,90	I1R60605	80,20
8" x 6"	219,1 x 168,3	I1R40806	109,35	I1R60806	140,70

ACESSÓRIOS PARA SOLDAR - NORMA ASTM - SCH 40S FABRICADO TUBO SOLDADO



CURVA 90° RAIO LONGO

Ø	Ø EXT mm.	ESPESSOR	AISI 316L	
			COD.	€
1/2"	21,3	2,77	I4CL960M	6,20
3/4"	26,7	2,87	I4CL960T	8,35
1"	33,4	3,38	I4CL9601	9,75
1 1/4"	42,2	3,56	I4CL961C	11,10
1 1/2"	48,3	3,68	I4CL961M	14,00
2"	60,3	3,91	I4CL9602	21,35
2 1/2"	73,0	5,16	I4CL962M	41,70
3"	88,9	5,46	I4CL9603	61,85
4"	114,3	6,02	I4CL9604	115,15
5"	141,3	6,55	I4CL9605	204,65
6"	168,3	7,11	I4CL9606	293,60
8"	219,1	8,18	I4CL9608	601,85
10"	273,0	9,27	I4CL9610	1.396,25

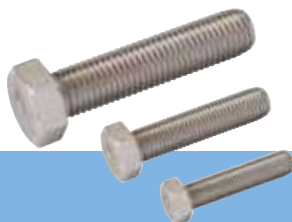
PARAFUSOS EM AÇO INOXIDÁVEL

**PARAFUSO HEXAGONAL
DIN 933 - INOX A2**

MEDIDA	COMPRIM			COD.	€ 100 UNID.
M12	50	300	50	TI331250	63,00
M12	60	300	50	TI331260	72,45
M14	60	200	50	TI331460	110,25
M14	70	150	50	TI331470	126,00
M14	80	150	50	TI331480	131,25
M16	40	200	25	TI331640	110,25
M16	50	150	25	TI331650	126,00
M16	60	150	25	TI331660	141,75
M16	70	150	25	TI331670	157,50
M16	80	100	25	TI331680	173,25
M16	90	100	25	TI331690	189,00
M16	100	100	25	TI331610	210,00
M16	110	100	25	TI331611	225,75
M16	120	75	25	TI331612	241,50
M20	70	75	25	TI332070	267,75
M20	80	75	25	TI332080	294,00
M20	90	50	25	TI332090	315,00
M20	100	50	25	TI332010	346,50
M20	110	50	25	TI332011	372,75
M20	120	50	25	TI332012	399,00
M24	90	40	20	TI332490	546,00
M27	120	20	10	TI332712	966,00
M30	130	20	10	TI333013	1.333,50
M33	140	15	5	TI333314	1.701,00

**PORCA HEXAGONAL
DIN 934 - INOX A2**

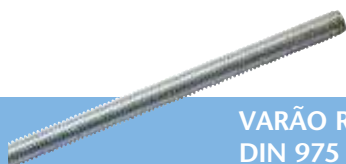
MEDIDA			COD.	€ 100 UNID.
M6	7.200	150	TI934006	3,15
M8	3.750	125	TI934008	6,30
M10	1.600	100	TI934010	13,65
M12	1.200	100	TI934012	19,95
M14	800	50	TI934014	29,40
M16	600	50	TI934016	40,95
M18	400	25	TI934018	60,90
M20	300	25	TI934020	75,60
M24	160	10	TI934024	141,75
M27	100	10	TI934027	273,00
M30	80	10	TI934030	367,50
M33	50	5	TI934033	493,50

**VARÃO ROSCADO 1.000 mm.
DIN 975 - INOX A2**

MEDIDA		COD.	€ 100 UNID.
M6	50	TI975006	204,75
M8	25	TI975008	357,00
M10	25	TI975010	556,50
M12	20	TI975012	813,75
M14	15	TI975014	1.102,50
M16	10	TI975016	1.485,75
M18	5	TI975018	1.895,25
M20	5	TI975020	2.383,50

**ANILHA PLANA
DIN 125 - INOX A2**

MEDIDA			COD.	€ 100 UNID.
M6	7.200	150	TI125006	1,05
M8	6.000	125	TI125008	2,10
M10	4.800	100	TI125010	4,20
M12	3.000	100	TI125012	9,45
M14	2.100	70	TI125014	13,65
M16	1.680	70	TI125016	13,65
M18	1.200	50	TI125018	16,80
M20	1.200	50	TI125020	19,95
M24	600	50	TI125024	39,90
M27	400	50	TI125027	50,40
M30	300	50	TI125030	66,15
M33	240	30	TI125033	92,40

ABRAÇADEIRAS



ABRAÇADEIRA INOX AISI 304
M8/M10

ESPESSURA DA BANDA 2,5 mm.

POLEGADAS	mm.	TUERCA		COD.	€
3/8"	16-18	M8	150 2	IRAF5102	2,35
1/2"	20-22	M8	100 2	IRAF5103	2,45
3/4"	25-28	M8	100 2	IRAF5104	2,65
1"	31-34	M8	100 2	IRAF5105	2,75
1 1/4"	39-43	M8	100 2	IRAF5106	2,90
1 1/2"	45-48.5	M8	100 2	IRAF5107	3,00
2"	58-61	M8	100 2	IRAF5108	3,35
2 1/2"	73-76.5	M10	50 2	IRAF5109	5,50
3"	86-89	M10	50 2	IRAF510A	6,20
4"	110-115	M10	50 2	IRAF510C	6,50



ABRAÇADEIRA INOX AISI 304
M8/M10 COM BUCHA E PARAFUSO

ESPESSURA DA BANDA 2,5 mm.

POLG.	mm.	PARAFUSO	BUCHA		COD.	€
3/8"	16-18	M8x100	10x50	100 2	IRAF5502	3,55
1/2"	20-22	M8x100	10x50	100 2	IRAF5503	3,70
3/4"	25-28	M8x100	10x50	100 2	IRAF5504	3,95
1"	31-34	M8x100	10x50	100 2	IRAF5505	4,05
1 1/4"	39-43	M8x100	10x50	100 2	IRAF5506	4,25
1 1/2"	45-48.5	M8x100	10x50	50 2	IRAF5507	4,40
2"	58-61	M8x100	10x50	50 2	IRAF5508	5,05
2 1/2"	73-76.5	M10x120	12x60	20 2	IRAF5509	7,40
3"	86-89	M10x120	12x60	20 2	IRAF550A	8,30
4"	110-115	M10x120	12x60	20 2	IRAF550C	9,55

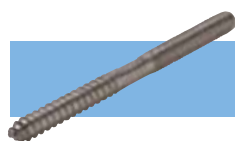

PARAFUSO AISI 304 ROSCA DUPLA

PORCA	mm.		COD.	€
M8	90	500 10	IRAFTD08	1,20
M10	120	500 10	IRAFTD10	2,35

ABRAÇADEIRAS EM "U"



ABRAÇADEIRA EM "U"
INOX AISI 304

Inclui porcas e anilhas. Nas medidas M6 e M8 as porcas e anilhas vêm montadas.

Ø TUBO	POLG.	PORCA		COD.	€ 100 UDS.
17,1	3/8"	M6	100 10	RFABI202	73,00
21,3	1/2"	M6	100 10	RFABI203	80,00
26,9	3/4"	M6	100 10	RFABI204	85,00
33,7	1"	M6	100 10	RFABI205	98,00
38,0	-	M6	100 10	RFABI238	100,00
42,2	1 1/4"	M6	100 5	RFABI206	101,00
48,3	1 1/2"	M8	50 5	RFABI207	205,00
54,0	-	M8	50 5	RFABI254	215,00
60,3	2"	M8	50 5	RFABI208	226,00
65,0	-	M8	50 5	RFABI265	235,00
76,1	2 1/2"	M8	25 5	RFABI20A	273,00
84,0	-	M8	25 5	RFABI284	284,00
88,9	3"	M8	25 5	RFABI20B	305,00
104,0	-	M10	20 2	RFABI210	536,00
114,4	4"	M10	20 2	RFABI20D	604,00
129,0	-	M10	20 2	RFABI213	667,00
139,7	5"	M10	20 2	RFABI20E	714,00
154,0	-	M10	16 2	RFABI215	809,00
168,3	6"	M10	16 2	RFABI20F	893,00
204,0	-	M10	10 2	RFABI220	1.015,00
219,1	8"	M10	10 2	RFABI20H	1.100,00
254,0	-	M10	6 2	RFABI225	1.310,00
NEW 273,0	10"	M10	6 2	RFABI20N	1.400,00
304,0	-	M10	6 2	RFABI230	1.490,00



FLANGE PRENSADA

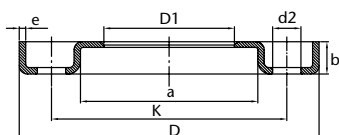

A montagem de flanges prensadas realiza-se com os respetivos adaptadores e juntas. Com os parafusos adequados obtêm-se uma perfeita estanquidade através da respetiva junta.

DN	Ø mm.	DIMENSÕES (mm.)								AISI 304L		AISI 316L	
		D1	D	K	a	e	b	d2	Nº Tal.	COD.	€	COD.	€
15	21,3	24	95	65	38	3	11,5	13,5	4	I4642015	9,15	I6642015	12,40
20	26,9	30	105	75	48	3	14,0	13,5	4	I4642020	10,45	I6642020	15,20
25	33,7	37	115	85	53	3	16,0	13,5	4	I4642025	13,10	I6642025	15,70
32	42,4	46	140	100	68	3	16,5	17,5	4	I4642032	16,40	I6642032	20,10
40	48,3	54	150	110	77	3	17,5	17,5	4	I4642040	18,10	I6642040	25,30
50	60,3	65	165	125	91	3	19,5	17,5	4	I4642050	20,15	I6642050	29,70
50	53,0	58	165	125	91	3	19,5	17,5	4	I4642053	19,15		
65	76,1	81	185	145	108	4	21,0	17,5	4	I4642065	25,30	I6642065	43,25
65	73,0	78	185	145	108	4	21,0	17,5	4	I4642073	25,25		
80	88,9	94	200	160	123	4	22,0	17,5	8	I4642080	33,55	I6642080	53,80
80	84,0	89	200	160	123	4	22,0	17,5	8	I4642084	32,40		
100	114,3	119	220	180	141	4	23,0	17,5	8	I4642100	38,45	I6642100	69,05
100	104,0	110	220	180	141	4	23,0	17,5	8	I4642104	34,60		
125	139,7	145	250	210	168	5	25,0	17,5	8	I4642125	64,30	I6642125	78,65
125	129,0	135	250	210	168	5	25,0	17,5	8	I4642129	59,30		
150	168,3	173	285	240	192	5	27,0	21,5	8	I4642150	72,50	I6642150	107,20
150	154,0	160	285	240	192	5	27,0	21,5	8	I4642154	66,70		
200	219,1	225	340	295	245	6	31,0	21,5	8	I4642200	116,95	I6642200	168,20
200	204,0	212	340	295	245	6	31,0	21,5	8	I4642204	116,75		
250	273,1	279	395	350	295	6	31,0	22,0	12	I4642250	177,45	I6642250	230,60
250	254,0	262	395	350	295	6	31,0	22,0	12	I4642254	147,00		
300	323,9	329	445	400	345	6	34,0	22,0	12	I4642300	199,80	I6642300	266,80

FLANGES ALUMÍNIO



FLANGE PLANA EM ALUMÍNIO ISO CONFORME DIN 2642

DN	Ø	D1	PN	DIMENSÕES (mm)			PARAFUSO		B1	COD.	€
				D	K	D5 (ISO)	NR	L			
40	1 1/2"	48,3	10	150	110	54	4	18	16	FPA10040	8,95
50	2"	60,3	10	165	125	65	4	18	16	FPA10050	9,95
65	2 1/2"	76,1	10	185	145	81	4	18	16	FPA10065	12,30
80	3"	88,9	10	200	160	94	8	18	18	FPA10080	14,85
100	4"	114,3	10	220	180	119	8	18	18	FPA10100	16,15
125	5"	139,7	10	250	210	145	8	18	18	FPA10125	19,95
150	6"	168,3	10	285	240	173	8	22	18	FPA10150	24,80
200	8"	219,1	10	340	295	225	8	22	20	FPA10200	35,00
250	10"	273,0	10	395	350	279	12	22	22	FPA10250	46,25
300	12"	323,9	10	445	400	329	12	22	22	FPA10300	59,55

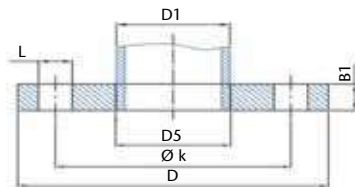

FLANGE PLANA EM ALUMÍNIO BRANCO DIN 2642

DN	Ø	D1	PN	NORMA	DIMENSÕES (mm)			PARAFUSO		B1	COD.	€
					D	K	D5 (ISO)	NR	L			
25	1"	33,7	10	ISO	115	85	36	4	M12	12	FPAB0025	5,75
32	1 1/4"	42,4	10	ISO	140	100	46	4	M16	16	FPAB0032	9,15
40	1 1/2"	43,0	10	MÉTRICO	150	110	48	4	M16	16	FPABM043	10,50
40	1 1/2"	48,3	10	ISO	150	110	54	4	M16	16	FPAB0040	12,50
50	2"	53,0	10	MÉTRICO	165	125	60	4	M16	16	FPABM053	14,70
50	2"	60,3	10	ISO	165	125	65	4	M16	16	FPAB0050	14,50
65	2 1/2"	73,0	10	MÉTRICO	185	145	75	4	M16	16	FPABM073	15,25
65	2 1/2"	76,1	10	ISO	185	145	81	4	M16	16	FPAB0065	16,45
80	3"	84,0	10	MÉTRICO	200	160	90	8	M16	18	FPABM084	16,90
80	3"	88,9	10	ISO	200	160	94	8	M16	18	FPAB0080	18,50
100	4"	104,0	10	MÉTRICO	220	180	111	8	M16	18	FPABM104	21,05
100	4"	114,3	10	ISO	220	180	119	8	M16	18	FPAB0100	18,95
125	5"	129,0	10	MÉTRICO	250	210	136	8	M16	18	FPABM129	23,40
125	5"	139,7	10	ISO	250	210	145	8	M16	18	FPAB0125	21,90
150	6"	154,0	10	MÉTRICO	285	240	161	8	M20	18	FPABM154	32,60
150	6"	168,3	10	ISO	285	240	173	8	M20	18	FPAB0150	26,85
200	8"	204,0	10	MÉTRICO	340	295	212	8	M20	20	FPABM204	48,40
200	8"	219,1	10	ISO	340	295	225	8	M20	20	FPAB0200	41,95
250	10"	254,0	10	MÉTRICO	395	350	264	12	M20	22	FPABM254	54,50
250	10"	273,0	10	ISO	395	350	279	12	M20	22	FPAB0250	48,50
300	12"	304,0	10	MÉTRICO	445	400	315	12	M20	22	FPABM304	58,60
300	12"	323,9	10	ISO	445	400	329	12	M20	22	FPAB0300	54,50



FLANGES EM AÇO INOXIDÁVEL FORJADAS

DIMENSÕES			FLANGE PLANA CONFORME NORMA EN 1092-1 01									
			AISI 304L									
			PN 10		PN 16				PN 25		PN 40	
DN	POLG.	mm.	COD.	€	COD.	€	COD. EN	€			COD.	€
15	1/2"	21,3	IF414015	14,75			IF414015	14,75	IF414015	14,75	IF414015	14,75
20	3/4"	26,9	IF414020	20,95			IF414020	20,95	IF414020	20,95	IF414020	20,95
25	1"	33,7	IF414025	25,85			IF414025	25,85	IF414025	25,85	IF414025	25,85
32	1 1/4"	42,4	IF414032	36,90			IF414032	36,90	IF414032	36,90	IF414032	36,90
40	1 1/2"	48,3	IF414040	39,20			IF414040	39,20	IF414040	39,20	IF414040	39,20
50	2"	60,3	IF416050	53,70			IF416050	53,70	IF416050	53,70	IF416050	53,70
65	2 1/2"	76,1	I4576065	65,25			I4576065	65,25				
65	2 1/2"	76,1	IF416065	65,25			IF416065	65,25	IF414065	71,70	IF414065	71,70
80	3"	88,9	IF416080	72,10			IF416080	72,10	IF414080	79,35	IF414080	79,35
100	4"	114,3	IF416100	76,25			IF416100	76,25	IF414100	83,80	IF414100	83,80
125	5"	139,7	IF416125	111,55			IF416125	111,55	IF414125	134,70	IF414125	134,70
150	6"	168,3	IF416150	145,10			IF416150	145,10	IF414150	169,40	IF414150	169,40
200	8"	219,1	IF411200	217,30			IF416200	220,05	IF412200	242,15	IF414200	294,30
250	10"	273,0	IF411250	251,95			IF416250	277,70	IF412250	330,50	IF414250	481,75
300	12"	323,9	IF411300	305,30			IF416300	386,70	IF412300	437,30	IF414300	741,55
350	14"	355,6	IF411350	666,10	I4502350*	675,20	IF416350	702,30				
400	16"	406,4	IF411400	701,75			IF416400	722,20				
450	18"	457,0	IF411450	916,25								
500	20"	508,0	IF411500	1.037,45	I4502500*	1.148,00	IF416500	1.152,30				
600	24"	610,0	IF411600	1.222,00	IF416600	2.060,75						
700	28"	711,0	IF411700	1.399,15	IF416700	2.086,35						
800	32"	813,0	IF411800	2.228,60	IF416800	2.228,60						

* Até fim de existências

 Flanges não normalizadas
 4 Furos
 Conforme DIN 2502

DIMENSÕES			FLANGE CEGA CONFORME NORMA EN 1092-1 05					
			AISI 304L					
			PN 10		PN 16		PN 40	
DN	POLG.	mm.	COD.	€	COD.	€	COD.	€
15	1/2"	21,3	IF454015	17,50	IF454015	17,50	IF454015	17,50
20	3/4"	26,9	I4527020*	19,80	I4527020*	19,80		
	3/4"	26,9	IF454020	25,45	IF454020	25,45	IF454020	25,45
25	1"	33,7	IF454025	28,25	IF454025	28,25	IF454025	28,25
32	1 1/4"	42,4						
	1 1/4"	42,4	IF454032	41,80	IF454032	41,80	IF454032	41,80
40	1 1/2"	48,3	IF454040	49,10	IF454040	49,10	IF454040	49,10
50	2"	60,3	IF456050	59,05	IF456050	59,05	IF456050	59,05
65	2 1/2"	76,1	IF456065	82,10	IF456065	82,10		
80	3"	88,9	IF456080	92,40	IF456080	92,40		
100	4"	114,3	IF456100	108,90	IF456100	108,90		
125	5"	139,7	IF456125	156,70	IF456125	156,70		
150	6"	168,3	IF456150	207,25	IF456150	207,25		
200	8"	219,1	IF451200	322,65	IF456200	337,85		
250	10"	273,0	IF451250	528,60	IF456250	548,40		
300	12"	323,9	IF451300	645,70	IF456300	706,65		
350	14"	355,6	IF451350	745,40	IF456350	767,20		
400	16"	406,4	IF451400	1.089,85	IF456400	1.096,50		
500	20"	508,0	IF451500	1.615,55	IF456500	2.125,80		

* Até fim de existências

 Conforme DIN 2527

FLANGE PLANA CONFORME NORMA EN 1092-1 01

AISI 316L									
PN 10		PN 16				PN 25		PN40	
COD. DIN	€	COD.	€	COD. EN	€	COD.	€	COD.	€
IF614015	21,05			IF614015	21,05	IF614015	21,05	IF614015	21,05
IF614020	25,80			IF614020	25,80	IF614020	25,80	IF614020	25,80
IF614025	34,55			IF614025	34,55	IF614025	34,55	IF614025	34,55
IF614032	52,00			IF614032	52,00	IF614032	52,00	IF614032	52,00
IF614040	53,50			IF614040	53,50	IF614040	53,50	IF614040	53,50
IF616050	69,50			IF616050	69,50	IF616050	69,50	IF616050	69,50
I6576065	76,10			I6576065	76,10				
IF616065	76,10			IF616065	76,10	IF614065	83,65	IF614065	83,65
IF616080	90,80			IF616080	90,80	IF614080	99,90	IF614080	99,90
IF616100	104,30			IF616100	104,30	IF614100	136,40	IF614100	136,40
IF616125	154,55			IF616125	154,55	IF614125	184,05	IF614125	184,05
IF616150	175,75			IF616150	175,75	IF614150	231,50	IF614150	231,50
IF611200	262,35			IF616200	262,35	IF612200	321,35	IF614200	402,25
IF611250	335,30			IF616250	335,30	IF612250	451,70	IF614250	658,40
IF611300	364,80			IF616300	490,00	IF612300	597,80	IF614300	1.013,45
IF611350	674,25	I6502350*	793,00	IF616350	801,50				
IF611400	798,40			IF616400	874,30				
IF611450	1.019,90								
IF611500	1.277,15			IF616500	1.555,75				
IF611600	1.382,50	IF616600	1.841,85						
IF611700	2.047,30	IF616700	2.818,80						
IF611800	2.490,15	IF616800	2.864,50						

FLANGE CEGA CONFORME NORMA EN 1092-1 05

AISI 316L					
PN 10		PN 16		PN40	
COD.	€	COD.	€	COD.	€
IF654015	20,55	IF654015	20,55	IF654015	20,55
IF654020	28,25	IF654020	28,25	IF654020	28,25
IF654025	32,45	IF654025	32,45	IF654025	32,45
I6527032*	40,10	I6527032*	40,10		
IF654032	52,60	IF654032	52,60	IF654032	52,60
IF654040	55,45	IF654040	55,45	IF654040	55,45
IF656050	73,10	IF656050	73,10	IF656050	73,10
IF656065	90,00	IF656065	90,00		
IF656080	110,90	IF656080	110,90		
IF656100	158,40	IF656100	158,40		
IF656125	212,65	IF656125	212,65		
IF656150	247,40	IF656150	247,40		
IF651200	443,25	IF656200	446,05		
IF651250	613,05	IF656250	621,15		
IF651300	825,90	IF656300	953,10		
IF651350	1.034,55	IF656350	1.258,30		
IF651400	1.268,10	IF656400	1.697,35		
IF651500	2.375,80	IF656500	3.370,70		

DIMENSÕES			FLANGE COM COLARINHO CONFORME NORMA EN 1092-1 11					
			AISI 304L					
			PN 10		PN 16		PN 40	
DN	POLG.	mm.	COD.	€	COD.	€	COD.	€
15	1/2"	21,3	I4633015*	11,70	I4633015*	11,70		
	1/2"	21,3	IF424015	15,70	IF424015	15,70	IF424015	15,70
20	3/4"	26,9	I4633020*	17,80	I4633020*	17,80		
	3/4"	26,9	IF424020	22,70	IF424020	22,70	IF424020	22,70
25	1"	33,7	IF424025	26,00	IF424025	26,00	IF424025	26,00
32	1 1/4"	42,4	I4633032*	34,60	I4633032*	34,60		
	1 1/4"	42,4	IF424032	41,15	IF424032	41,15	IF424032	41,15
40	1 1/2"	48,3	IF424040	46,65	IF424040	46,65	IF424040	46,65
50	2"	60,3	IF426050	54,95	IF426050	54,95	IF426050	54,95
65	2 1/2"	76,1	I4633065	73,30	I4633065	73,30		
	2 1/2"	76,1	IF426065	73,30	IF426065	73,30		
80	3"	88,9	IF426080	87,50	IF426080	87,50		
100	4"	114,3	IF426100	99,15	IF426100	99,15		
125	5"	139,7	IF426125	140,95	IF426125	140,95		
150	6"	168,3	IF426150	185,95	IF426150	185,95		
200	8"	219,1			IF426200	280,15		
250	10"	273,0			IF426250	372,90		
300	12"	323,9			IF426300	521,55		
350	14"	355,6			IF426350	729,35		
400	16"	406,4			IF426400	1.119,05		
500	20"	508,0			IF426500	1.538,70		

* Até fim de existências

4 Furos

Conforme DIN 2633



DIMENSÕES			FLANGE PLANA MM CONFORME NORMA EN 1092-1 01 / DIN 2576											
			AISI 304L						AISI 316L					
			PN 10		PN 16		PN 40		PN 10		PN 16		PN 40	
DN	POLG.	mm.	COD.	€	COD.	€	COD.	€	COD.	€	COD.	€	COD.	€
15	1/2"	18	IM414015	17,20	IM414015	17,20	IM414015	17,20	IM614015	21,95	IM614015	21,95	IM614015	21,95
20	3/4"	23	IM414020	25,10	IM414020	25,10	IM414020	25,10	IM614020	28,20	IM614020	28,20	IM614020	28,20
25	1"	28	IM414025	26,95	IM414025	26,95	IM414025	26,95	IM614025	32,05	IM614025	32,05	IM614025	32,05
32	1 1/4"	38	IM414032	41,85	IM414032	41,85			IM614032	50,20	IM614032	50,20		
40	1 1/2"	43	IM414040	46,80	IM414040	46,80			IM614040	58,75	IM614040	58,75		
50	2"	53	IM416050	61,05	IM416050	61,05			IM616050	75,90	IM616050	75,90		
65	2 1/2"	73	IM416065	72,95	IM416065	72,95			IM616065	83,95	IM616065	83,95		
80	3"	84	IM416080	81,05	IM416080	81,05			IM616080	101,55	IM616080	101,55		
100	4"	104	IM416100	93,85	IM416100	93,85			IM616100	119,35	IM616100	119,35		
125	5"	129	IM416125	131,90	IM416125	131,90			IM616125	162,00	IM616125	162,00		
150	6"	154	IM416150	170,55	IM416150	170,55			IM616150	209,30	IM616150	209,30		
200	8"	204	IM411200	224,70	IM416200	227,35			IM611200	272,95	IM616200	290,70		
250	10"	254	IM411250	300,05	IM416250	311,10			IM611250	387,35	IM616250	430,65		
300	12"	304	IM411300	377,50	IM416300	458,30			IM611300	435,25	IM616300	555,00		

FLANGE COM COLARINHO CONFORME NORMA EN 1092-1 11

AISI 316L					
PN 10		PN 16		PN40	
COD.	€	COD.	€	COD.	€
IF624015	19,05	IF624015	19,05	IF624015	19,05
IF624020	33,3	IF624020	33,3	IF624020	33,3
IF624025	32,95	IF624025	32,95	IF624025	32,95
IF624032	45,8	IF624032	45,8	IF624032	45,8
IF624040	55,6	IF624040	55,6	IF624040	55,6
IF626050	65,8	IF626050	65,8	IF626050	65,8
I6633065	75,55	I6633065	75,55		
IF626065	75,55	IF626065	75,55		
IF626080	104,3	IF626080	104,3		
IF626100	125,95	IF626100	125,95		
IF626125	187,7	IF626125	187,7		
IF626150	224,45	IF626150	224,45		
		IF626200	334,95		
		IF626250	468		
		IF626300	618,5		
		IF626350	951,65		
		IF626400	1.189,65		
		IF626500	1.982,65		

ACESSÓRIOS
INOXIDÁVEL

DIMENSÕES			FLANGE ROSCADA CONFORME DIMENSÕES EN 1092-1 01							
			AISI 304L				AISI 316L			
			PN 10-16		PN 40		PN 10-16		PN 40	
DN	POLG.	mm.	COD.	€	COD.	€	COD. DIN	€	COD. EN	€
15	1/2"	21,3	IR416015	17,35	IR416015	17,35	IR616015	20,25	IR616015	20,25
20	3/4"	26,9	IR416020	23,30	IR416020	23,30	IR616020	27,80	IR616020	27,80
25	1"	33,7	IR416025	28,25	IR416025	28,25	IR616025	34,05	IR616025	34,05
32	1 1/4"	42,4	IR416032	38,85	IR416032	38,85	IR616032	47,90	IR616032	47,90
40	1 1/2"	48,3	IR416040	43,80	IR416040	43,80	IR616040	52,75	IR616040	52,75
50	2"	60,3	IR416050	53,25	IR416050	53,25	IR616050	69,60	IR616050	69,60
65	2 1/2"	76,1	IR416065	65,35			IR616065	92,75		
80	3"	88,9	IR416080	76,20			IR616080	109,35		
100	4"	114,3	IR416100	90,55			IR616100	119,85		

DIMENSÕES			FLANGE FORJADA ASME B 16.5 ASTM A182 - 150 LBS.					
			AISI 316L					
			WELDING NECK		SLIP ON		BLIND	
DN	POLG.	mm.	COD.	€	COD.	€	COD.	€
15	1/2"	21,3	IN150015	16,40	IO150015	12,95	IB150015	12,30
20	3/4"	26,9	IN150020	23,95	IO150020	20,90	IB150020	17,10
25	1"	33,7	IN150025	34,60	IO150025	25,05	IB150025	25,30
32	1 1/4"	42,4	IN150032	44,70	IO150032	33,70	IB150032	32,45
40	1 1/2"	48,3	IN150040	57,65	IO150040	54,20	IB150040	42,55
50	2"	60,3	IN150050	84,10	IO150050	64,15	IB150050	65,35
65	2 1/2"	76,1	IN150065	134,25	IO150065	103,70	IB150065	107,05
80	3"	88,9	IN150080	161,75	IO150080	119,40	IB150080	133,80
100	4"	114,3	IN150100	220,90	IO150100	160,00	IB150100	184,20
125	5"	139,7	IN150125	277,15	IO150125	182,25	IB150125	226,05
150	6"	168,3	IN150150	338,60	IO150150	221,00	IB150150	293,90
200	8"	219,1	IN150200	561,05	IO150200	360,20	IB150200	545,60
250	10"	273,0	IN150250	766,15	IO150250	492,20	IB150250	745,55

ACESSÓRIOS

JOGO DE JUNTAS PTFE VÁLV. INOX 2 CORPOS FLANGEADA

Ø	COD.	€/Juego
1/2"	IVB2J015	1,15
3/4"	IVB2J020	1,55
1"	IVB2J025	1,85
1 1/4"	IVB2J032	3,35
1 1/2"	IVB2J040	4,50
2"	IVB2J050	7,90
2 1/2"	IVB2J065	9,75
3"	IVB2J080	12,95
4"	IVB2J100	22,50
5"	IVB2J125	34,95
6"	IVB2J150	51,15

JOGO DE JUNTAS PTFE VÁLV. INOX 3 CORPOS

Ø	COD.	€/Juego
1/2"	IVB3PJ3	2,90
3/4"	IVB3PJ4	3,85
1"	IVB3PJ5	5,55
1 1/4"	IVB3PJ6	7,90
1 1/2"	IVB3PJ7	11,65
2"	IVB3PJ8	17,35
2 1/2"	IVB3PJ9	33,20
3"	IVB3PJPA	49,80
4"	IVB3PJPC	82,25

RECOBRIMENTO MANÍPULO VERMELHO VÁLV. INOX 1 CORPO

Ø	COD.	€
1/4"	IVB1PMR1	0,25
3/8"	IVB1PMR2	0,25
1/2" - 3/4"	IVB1PMR3	0,25
1" - 1 1/4"	IVB1PMR5	0,40
1 1/2"	IVB1PMR7	0,55
2"	IVB1PMR8	0,55

RECOBRIMENTO MANÍPULO VERMELHO VÁLV. INOX 2 CORPOS

Ø	COD.	€
1/4" - 1/2"	IVB2PMR1	0,25
3/4"	IVB2PMR4	0,25
1"	IVB2PMR5	0,40
1 1/4"	IVB2PMR6	0,40
1 1/2"	IVB2PMR7	0,55
2"	IVB2PMR8	0,55
2 1/2" - 3"	IVB2PMR9	0,95
4"	IVB2PMRC	1,50

RECOBRIMENTO MANÍPULO VERMELHO VÁLV. INOX 3 CORPOS

Ø	COD.	€
1/4" - 1/2"	IVB3PMR1	0,25
3/4" - 1"	IVB3PMR4	0,30
1 1/4" - 1 1/2"	IVB3PMR6	0,55
2"	IVB3PMR8	0,75
2 1/2" - 3"	IVB3PMR9	0,95
4"	IVB3PMRC	1,50

MALHA FILTRO "Y" AISI 316

Ø	COD.	€
1/2"	IVFM0063	1,95
3/4"	IVFM0064	2,65
1"	IVFM0065	2,75
1 1/4"	IVFM0066	3,30
1 1/2"	IVFM0067	5,00
2"	IVFM0068	5,65

ACESSÓRIOS PARA INDUSTRIA ALIMENTAR NW - DIN 11851

CASQUILHO

Ø			SERIE 1				SERIE 2				POLIDO	
			COD. AISI 304	€	COD. AISI 316	€	COD. AISI 304	€	COD. AISI 316	€	COD. AISI 316	€
10	700	10									I3816M02	4,00
15	700	10			I3816003	3,85			I3816203	3,85	I3816M03	4,00
20	400	10			I3816004	5,65			I3816204	5,65	I3816M04	5,70
25	225	5	I3814005	4,80	I3816005	6,15	I3814205	4,80	I3816205	6,15	I3816M05	6,40
32	180	5	I3814006	5,45	I3816006	7,10	I3814206	5,45	I3816206	7,10	I3816M06	7,35
40	150	5	I3814007	5,75	I3816007	7,60	I3814207	5,75	I3816207	7,60	I3816M07	7,95
50	90	5	I3814008	7,05	I3816008	9,65	I3814208	7,05	I3816208	9,65	I3816M08	10,45
65	48	2	I3814009	11,00	I3816009	15,20	I3814209	11,00	I3816209	15,20	I3816M09	16,70
80	28	2	I381400A	15,30	I381600A	21,45	I381420A	15,30	I381620A	21,45	I3816M0A	22,85
100	20	2	I381400C	23,15	I381600C	33,35	I381420C	23,15	I381620C	33,35	I3816M0C	38,80
125	10	1			I381600D	49,75			I381620D	49,75		
150	5	1			I381600E	77,85			I381620E	77,85		

LIGAÇÃO MACHO

Ø			SERIE 1				SERIE 2				POLIDO	
			COD. AISI 304	€	COD. AISI 316	€	COD. AISI 304	€	COD. AISI 316	€	COD. AISI 316	€
10	500	10									I3806M02	4,30
15	500	10			I3806003	5,30			I3806203	5,30	I3806M03	5,35
20	300	10			I3806004	6,95			I3806204	6,95	I3806M04	7,05
25	160	5	I3804005	5,90	I3806005	7,60	I3804205	5,90	I3806205	7,60	I3806M05	7,95
32	120	5	I3804006	6,80	I3806006	8,95	I3804206	6,80	I3806206	8,95	I3806M06	9,50
40	75	5	I3804007	7,50	I3806007	10,10	I3804207	7,50	I3806207	10,10	I3806M07	10,80
50	60	5	I3804008	9,60	I3806008	13,35	I3804208	9,60	I3806208	13,35	I3806M08	14,25
65	36	2	I3804009	13,75	I3806009	19,40	I3804209	13,75	I3806209	19,40	I3806M09	21,85
80	24	2	I380400A	21,35	I380600A	30,20	I380420A	21,35	I380620A	30,20	I3806M0A	32,45
100	12	2	I380400C	28,95	I380600C	41,10	I380420C	28,95	I380620C	41,10	I3806M0C	49,45
125	10	1			I380600D	73,00			I380620D	73,00		
150	5	1			I380600E	113,40			I380620E	113,40		



PORCA ROSCADA AISI 304

Ø	📦		COD.	€
15	300	10	I3744003	6,15
20	180	10	I3744004	7,35
25	150	5	I3744005	7,35
32	125	5	I3744006	7,55
40	80	5	I3744007	8,20
50	55	5	I3744008	9,25
65	30	2	I3744009	14,40
80	16	2	I374400A	21,80
100	14	2	I374400C	25,40
125	12	1	I374400D	43,20
150	10	1	I374400E	66,45



PORCA CEGA AISI 304 COM JUNTA EPDM E CADEADO

Ø	📦		COD.	€
25	85	5	I3834005	17,20
32	60	5	I3834006	21,35
40	60	5	I3834007	24,10
50	50	5	I3834008	29,70
65	36	2	I3834009	42,60
80	20	2	I383400A	54,25
100	12	2	I383400C	68,55



JUNTA PARA ACESSÓRIO

Ø	📦		COD. EPDM	€	COD. NBR	€
15	300	10	IJAL0003	0,50	IJALN003	0,50
20	300	10	IJAL0004	0,50	IJALN004	0,50
25	680	10	IJAL0005	0,60	IJALN005	0,60
32	900	10	IJAL0006	0,60	IJALN006	0,60
40	700	10	IJAL0007	0,60	IJALN007	0,60
50	700	10	IJAL0008	0,65	IJALN008	0,70
65	600	10	IJAL0009	1,10	IJALN009	1,10
80	600	10	IJAL000A	1,15	IJALN00A	1,20
100	500	10	IJAL000C	1,65	IJALN00C	2,50
125	-	6	IJAL000D	1,95	IJALN00D	2,55
150	-	5	IJAL000E	3,95	IJALN00E	4,15



JUNTA EPDM PARA PORCA CEGA

Ø	📦		COD.	€
25	680	10	IJALCE05	1,95
32	900	10	IJALCE06	2,00
40	700	10	IJALCE07	2,15
50	700	10	IJALCE08	2,70
65	300	10	IJALCE09	3,15
80	300	10	IJALCE0A	3,55
100	250	10	IJALCE0C	4,50

ACESSÓRIOS PARA INDUSTRIA ALIMENTAR - SMS 1146



CASQUILHO AISI 316L

Ø	📦		COD.	€
25	225	5	I3816S05	4,50
38	150	5	I3816S06	5,95
51	90	5	I3816S07	7,30
63,5	48	2	I3816S08	10,95
76	40	2	I3816S09	12,30
101,6	20	2	I3816S0A	19,45
104	16	2	I3816S0C	19,45



PORCA ROSCADA AISI 304

Ø	📦		COD.	€
25	150	5	I3744S05	4,95
38	60	5	I3744S06	7,80
51	40	5	I3744S07	9,45
63,5	30	2	I3744S08	13,05
76	16	2	I3744S09	17,10
101,6	14	2	I3744S0A	29,35
104	14	2	I3744S0C	23,10



LIGAÇÃO MACHO AISI 316L

Ø	📦		COD.	€
25	160	5	I3806S05	5,55
38	120	5	I3806S06	8,55
51	60	5	I3806S07	9,50
63,5	36	2	I3806S08	15,45
76	24	2	I3806S09	18,55
101,6	12	2	I3806S0A	36,35
104	12	2	I3806S0C	26,50



JUNTA PARA ACESSÓRIO



Ø	📦		COD. EPDM	€	COD. SILICONE	€
25	680	10	IJASE005	0,55	IJASS005	0,67
38	900	10	IJASE006	0,58	IJASS006	0,70
51	700	10	IJASE007	0,73	IJASS007	0,90
63,5	700	10	IJASE008	1,10	IJASS008	1,30
76	600	10	IJASE009	1,20	IJASS009	1,45
101,6	600	10	IJASE00A	1,55	IJASS00A	1,85
104	500	10	IJASE00C	1,55	IJASS00C	1,85

ACESSÓRIOS CLAMP EM INOX



ABRAÇADEIRA CLAMP AISI 304

Ø	POLG.	CASQUILHO CLAMP mm.		COD.	€
	1/2" - 3/4"	25,0	150 1	IRFC4008	7,60
10-15-20		34,0	100 1	IRFC4010	8,35
25-32-40	1" - 1.5"	50,5	80 1	IRFC4025	9,95
50	2"	64,0	70 1	IRFC4050	11,80
	2 1/2"	77,5	60 1	IRFC4060	13,00
65	3"	91,0	50 1	IRFC4065	14,45
80	3.5"	106,0	40 1	IRFC4080	16,15
100	4"	119,0	40 1	IRFC4100	17,40



TAMPÃO CLAMP CEGO AISI 316L

Ø	STANDARD	DIÂM. EXT TUBO		COD.	€
1/2" - 3/4"	3A	25,4	800 20	IRCB6009	4,45
10 - 15 - 20	DIN	34,0	800 20	IRCB6010	5,00
25 - 32 - 40	DIN	50,5	300 20	IRCB6025	5,60
50	DIN	64,0	200 10	IRCB6050	8,10
2 1/2"	3A	77,5	100 5	IRCB6060	9,95
65	DIN	91,0	60 5	IRCB6065	12,45
80	DIN	106,0	60 5	IRCB6080	16,80
100	DIN	119,0	40 5	IRCB6100	24,25



CASQUILHO CLAMP SOLDAR AISI 316L

Ø	STANDARD	DIÂM. EXT TUBO	DIÂM. EXT. CLAMP	COMPRIMENTO		COD.	€
1/2"	3A	12,7	25,4	28,6	350 10	IRCC6009	5,25
10	DIN	12,0	34,0	21,5	350 10	IRCC6010	5,25
15	DIN	18,0	34,0	21,5	350 10	IRCC6015	5,25
3/4"	3A	19,0	25,4	28,6	350 10	IRCC6016	5,10
20	DIN	22,0	34,0	21,5	250 10	IRCC6020	4,95
1"	3A	25,4	50,5	28,6	150 10	IRCC6022	6,45
25	DIN	28,0	50,5	21,5	180 10	IRCC6025	4,90
32	DIN	34,0	50,5	21,5	180 10	IRCC6032	4,85
1 1/2"	3A	38,1	50,5	28,6	150 10	IRCC6035	6,35
40	DIN	40,0	50,5	21,5	180 10	IRCC6040	4,80
2"	3A	50,8	64,0	28,6	120 10	IRCC6048	7,70
50	DIN	52,0	64,0	21,5	150 10	IRCC6050	6,35
2 1/2"	3A	63,5	77,5	28,6	70 10	IRCC6060	8,70
65	DIN	70,0	91,0	21,5	70 5	IRCC6065	10,10
3"	3A	76,2	91,0	28,6	40 5	IRCC6073	12,65
80	DIN	85,0	106,0	21,5	60 5	IRCC6080	12,45
4"	3A	101,6	119,0	28,6	25 5	IRCC6097	19,00
100	DIN	104,0	119,0	21,5	30 5	IRCC6100	14,90



JUNTA PARA CASQUILHO CLAMP

Ø	STANDARD	DIÂM. INT.	DIÂM. EXT.		COD. EPDM	€	COD. NBR	€
1/2"	3A	9,9	25,4	800 10	IRCJE009	0,65	IRCJN009	0,75
10	DIN	10,2	34,0	800 10	IRCJE010	0,65	IRCJN010	0,75
15	DIN	16,2	34,0	800 10	IRCJE015	0,65	IRCJN015	0,75
3/4"	3A	16,2	25,4	800 10	IRCJE016	0,65	IRCJN016	0,75
20	DIN	20,2	34,0	600 10	IRCJE020	0,65	IRCJN020	0,75
1"	3A	22,8	50,5	600 10	IRCJE022	1,00	IRCJN022	1,25
25	DIN	26,2	50,5	500 10	IRCJE025	1,00	IRCJN025	1,25
32	DIN	32,2	50,5	500 10	IRCJE032	1,00	IRCJN032	1,25
1 1/2"	3A	35,8	50,5	500 10	IRCJE035	1,00	IRCJN035	1,25
40	DIN	38,2	50,5	500 10	IRCJE040	1,00	IRCJN040	1,25
2"	3A	48,8	64,0	400 10	IRCJE048	1,25	IRCJN048	1,65
50	DIN	50,2	64,0	400 10	IRCJE050	1,25	IRCJN050	1,65
2 1/2"	3A	60,5	77,5	350 10	IRCJE060	1,75	IRCJN060	2,25
65	DIN	66,2	91,0	350 5	IRCJE065	2,00	IRCJN065	2,45
3"	3A	73,1	91,0	150 5	IRCJE073	2,00	IRCJN073	2,45
80	DIN	81,2	106,0	150 5	IRCJE080	2,45	IRCJN080	3,15
4"	3A	97,8	119,0	125 5	IRCJE097	2,95	IRCJN097	3,75
100	DIN	100,2	119,0	125 5	IRCJE100	2,95	IRCJN100	3,75

ACESSÓRIOS PARA SOLDAR – INDUSTRIA ALIMENTAR - DIN 11852

CURVA 90°

DN	ESPES. mm.	R mm.		SERIE 1					SERIE 2				
				DIAM. EXT. mm.	AISI 304		AISI 316L		DIAM. EXT. mm.	AISI 304		AISI 316L	
					COD.	€	COD.	€		COD.	€	COD.	€
10	1,5	26,0	10	12			IAC96010	7,30					
15	1,5	35,0	10	18			IAC96015	6,00	19			I2C96015	6,00
20	1,5	40,0	9	22			IAC96020	6,80	23			I2C96020	6,80
25	1,5	50,0	7	28	IAC94025	7,15	IAC96025	8,20	29	I2C94025	7,15	I2C96025	8,20
32	1,5	55,0	5	34	IAC94032	7,85	IAC96032	9,20	35	I2C94032	7,85	I2C96032	9,20
40	1,5	60,0	5	40	IAC94040	8,65	IAC96040	10,40	41	I2C94040	8,65	I2C96040	10,40
50	1,5	70,0	4	52	IAC94050	10,75	IAC96050	13,75	53	I2C94050	10,75	I2C96050	13,75
65	2,0	80,0	3	70	IAC94065	18,85	IAC96065	24,65					
80	2,0	90,0	2	85	IAC94080	23,05	IAC96080	30,70					
100	2,0	100,0	1	104	IAC94100	32,50	IAC96100	41,70					
125	2,0	187,5	1	129			IAC96125	104,00					
150	2,0	225,0	1	154			IAC96150	154,05					

TÊ

DN	ESPES. mm.	R mm.		SERIE 1					SERIE 2				
				DIAM. EXT. mm.	AISI 304		AISI 316L		DIAM. EXT. mm.	AISI 304		AISI 316L	
					COD.	€	COD.	€		COD.	€	COD.	€
10	1,5	26,0	4	12			IATL6010	11,70					
15	1,5	35,0	4	18			IATL6015	11,70	19			I2TL6015	11,70
20	1,5	40,0	4	22			IATL6020	11,90	23			I2TL6020	11,90
25	1,5	50,0	4	28	IATL4025	13,10	IATL6025	14,10	29	I2TL4025	13,10	I2TL6025	14,10
32	1,5	55,0	4	34	IATL4032	14,25	IATL6032	15,75	35	I2TL4032	14,25	I2TL6032	15,75
40	1,5	60,0	4	40	IATL4040	15,10	IATL6040	18,10	41	I2TL4040	15,10	I2TL6040	18,10
50	1,5	70,0	3	52	IATL4050	17,25	IATL6050	22,75	53	I2TL4050	17,25	I2TL6050	22,75
65	2,0	80,0	3	70	IATL4065	30,00	IATL6065	39,30					
80	2,0	90,0	2	85	IATL4080	35,85	IATL6080	47,75					
100	2,0	100,0	1	104	IATL4100	49,30	IATL6100	65,45					
125	2,0	187,5	1	129			IATL6125	141,20					
150	2,0	225,0	1	154			IATL6150	196,40					



REDUÇÃO CONCÊNTRICA AISI 316L

DN	ESPESS. mm.		SERIE 1			SERIE 2		
			DIAM. EXT. mm.	COD.	€	DIAM. EXT. mm.	COD.	€
DN 15 - DN 10	1,5	10	18 x 12	IARC6032	6,15			
DN 20 - DN 10	1,5	10	22 x 12	IARC6042	6,95			
DN 20 - DN 15	1,5	10	22 x 18	IARC6043	6,15	23 x 19	I2RC6043	6,15
DN 25 - DN 10	1,5	10	28 x 12	IARC6052	8,10			
DN 25 - DN 15	1,5	10	28 x 18	IARC6053	7,30			
DN 25 - DN 20	1,5	10	28 x 22	IARC6054	6,95	29 x 23	I2RC6054	6,95
DN 32 - DN 15	1,5	10	34 x 18	IARC6063	9,00			
DN 32 - DN 20	1,5	10	34 x 22	IARC6064	7,70	35 x 23	I2RC6064	7,70
DN 32 - DN 25	1,5	10	34 x 28	IARC6065	7,30	35 x 29	I2RC6065	7,30
DN 40 - DN 20	1,5	10	40 x 22	IARC6074	9,70	41 x 23	I2RC6074	9,70
DN 40 - DN 25	1,5	10	40 x 28	IARC6075	8,90	41 x 29	I2RC6075	8,90
DN 40 - DN 32	1,5	10	40 x 34	IARC6076	8,25	41 x 35	I2RC6076	8,25
DN 50 - DN 25	1,5	10	52 x 28	IARC6085	11,15	53 x 29	I2RC6085	11,15
DN 50 - DN 32	1,5	10	52 x 34	IARC6086	10,00	53 x 35	I2RC6086	10,00
DN 50 - DN 40	1,5	10	52 x 40	IARC6087	8,25	53 x 41	I2RC6087	8,25
DN 65 - DN 32	2,0	1	70 x 34	IARC6096	19,40	70 x 35	I2RC6096	19,40
DN 65 - DN 40	2,0	1	70 x 40	IARC6097	19,25	70 x 41	I2RC6097	19,25
DN 65 - DN 50	2,0	1	70 x 52	IARC6098	16,95	70 x 53	I2RC6098	16,95
DN 80 - DN 40	2,0	1	85 x 40	IARC60A7	25,40	85 x 41	I2RC60A7	25,40
DN 80 - DN 50	2,0	1	85 x 52	IARC60A8	21,20	85 x 53	I2RC60A8	21,20
DN 80 - DN 65	2,0	1	85 x 70	IARC60A9	16,95			
DN 100 - DN 50	2,0	1	104 x 52	IARC60C8	35,45	104 x 53	I2RC60C8	35,45
DN 100 - DN 65	2,0	1	104 x 70	IARC60C9	28,50			
DN 100 - DN 80	2,0	1	104 x 85	IARC60CA	23,85			

ACESSÓRIOS PARA SOLDAR – INDUSTRIA ALIMENTAR - SMS 1146

CURVA 90°

DN	ESPESS. mm.	DIAM. EXT. mm.	R mm.		AISI 304		AISI 316L	
					COD.	€	COD.	€
25	1,5	25,4	38,1	7	ISC94025	5,85	ISC96025	6,60
38	1,5	38,1	57,2	5	ISC94038	8,05	ISC96038	9,50
51	1,5	50,8	76,1	4	ISC94051	10,60	ISC96051	13,55
63	1,5	63,5	95,2	3	ISC94063	15,00	ISC96063	19,15
76	2,0	76,1	114,0	2	ISC94076	23,80	ISC96076	32,20
101	2,0	101,6	110,0	1	ISC94101	40,85	ISC96101	54,10

TÊ AISI 316L

DN	ESPESS. mm.	DIAM. EXT. mm.		COD.	€
25	1,5	25,4	4	ISTL6025	13,90
38	1,5	38,1	4	ISTL6038	18,90
51	1,5	50,8	2	ISTL6051	24,85
63	1,5	63,5	1	ISTL6063	35,85
76	2,0	76,1	1	ISTL6076	51,90
101	2,0	101,6	1	ISTL6101	87,75

REDUÇÃO CONCÊNTRICA AISI 316L

DN	DIAM. EXT. mm.		COD.	€
DN 38 - DN 25	38,1 x 25,4	10	ISR63825	9,50
DN 51 - DN 25	50,8 x 25,4	10	ISR65125	14,25
DN 51 - DN 38	50,8 x 38,1	10	ISR65138	11,10
DN 63 - DN 38	63,5 x 38,1	1	ISR66338	16,80
DN 63 - DN 51	63,5 x 50,8	1	ISR66351	14,25
DN 76 - DN 51	76,1 x 50,8	1	ISR67651	31,45
DN 76 - DN 63	76,1 x 63,5	1	ISR67663	25,10
DN 101 - DN 63	101,6 x 63,5	1	ISR61063	22,45
DN 101 - DN 76	101,6 x 76,1	1	ISR61076	20,80

VÁLVULAS – INDUSTRIA ALIMENTAR



VÁLVULA DE BORBOLETA PARA ALIMENTAR DIN 11851 – ROSCAR / ROSCAR

Produzida em aço inoxidável AISI 304.
Elastômetro em EPDM.
Extremos roscados conforme DIN 11851.
Pressão máxima de serviço: PN 10.
Temperatura de serviço: - 20° C a 130° C.

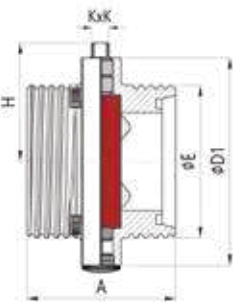

Ø	H	Ø E	KxK	A	Ø D1		COD.	€
25	50,5	RD52x1/6"	8 x 8	66	78	16 1	IV90E025	61,45
32	54,5	RD58x1/6"	8 x 8	70	86	16 1	IV90E032	66,90
40	56,0	RD65x1/6"	8 x 8	74	95	16 1	IV90E040	75,35
50	64,0	RD78x1/6"	8 x 8	76	108	8 1	IV90E050	93,80
65	74,0	RD95x1/6"	8 x 8	84	125	8 1	IV90E065	126,40
80	81,5	RD110x1/4"	10 x 10	90	140	6 1	IV90E080	164,65
100	91,5	RD130x1/4"	10 x 10	104	160	4 1	IV90E100	271,00



VÁLVULA DE BORBOLETA PARA ALIMENTAR DIN 11851 – ROSCAR / SOLDAR

Produzida em aço inoxidável AISI 304.
Elastômetro em EPDM.
Extremo rosçado conforme DIN 11851 / soldar.
Pressão máxima de serviço: PN 10.
Temperatura de serviço: - 20° C a 130° C.

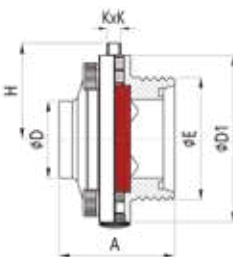

Ø	H	Ø D	Ø E	KxK	A	Ø D1		COD.	€
25	50,5	28	RD52x1/6"	8 x 8	58	78	16 1	IV91E025	54,45
32	54,5	34	RD58x1/6"	8 x 8	58	86	16 1	IV91E032	61,55
40	56,0	40	RD65x1/6"	8 x 8	60	95	16 1	IV91E040	70,05
50	64,0	52	RD78x1/6"	8 x 8	64	108	12 1	IV91E050	85,35
65	74,0	70	RD95x1/6"	8 x 8	68	125	8 1	IV91E065	113,75
80	81,5	85	RD110x1/4"	10 x 10	71	140	8 1	IV91E080	150,30
100	91,5	104	RD130x1/4"	10 x 10	84	160	4 1	IV91E100	220,65



VÁLVULA DE BORBOLETA PARA ALIMENTAR DIN 11851 – SOLDAR / SOLDAR

Produzida em aço inoxidável AISI 304.
Elastômetro em EPDM.
Extremo soldar / soldar.
Pressão máxima de serviço: PN 10.
Temperatura de serviço: - 20° C a 130° C.

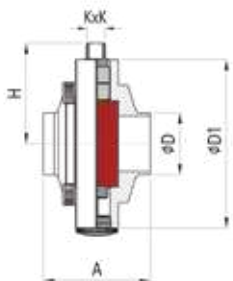

Ø	H	Ø D	KxK	A	Ø D1		COD.	€
25	50,5	28	8 x 8	50	78	16 1	IV92E025	45,35
32	54,5	34	8 x 8	50	86	16 1	IV92E032	61,30
40	56,0	40	8 x 8	50	95	16 1	IV92E040	65,20
50	64,0	52	8 x 8	52	108	12 1	IV92E050	74,20
65	74,0	70	8 x 8	56	125	8 1	IV92E065	95,10
80	81,5	85	10 x 10	60	140	8 1	IV92E080	131,55
100	91,5	104	10 x 10	64	160	4 1	IV92E100	163,55



MANIPULO PARA VÁLVULA DE BORBOLETA DIN 11851

Produzida em aço inoxidável AISI 304.
Acionamento manual em 3 posições.

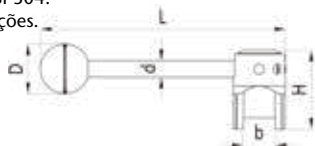

Ø	D	d	b	H	L		COD.	€
25-65	32	10,5	20,2	50	153	60 1	IV9P0025	21,80
80-100	40	12,0	22,1	56	203	40 1	IV9P0080	26,95



JUNTA PARA VÁLVULA DE BORBOLETA DIN 11851



Ø		COD. EPDM	€	COD. NBR	€	COD. SILICONE	€
25	384 2	IV9GE025	4,90	IV9GN025	5,40	IV9GS025	4,90
32	210 2	IV9GE032	5,40	IV9GN032	6,05	IV9GS032	5,40
40	148 2	IV9GE040	6,05	IV9GN040	6,55	IV9GS040	6,05
50	160 2	IV9GE050	7,10	IV9GN050	7,70	IV9GS050	7,10
65	84 2	IV9GE065	8,10	IV9GN065	8,60	IV9GS065	8,10
80	30 2	IV9GE080	10,80	IV9GN080	11,80	IV9GS080	10,80
100	36 2	IV9GE100	15,05	IV9GN100	16,40	IV9GS100	15,05



DISCO PARA VÁLVULA DE BORBOLETA DIN 11851

Ø		COD.	€
25	1	IV9D0025	12,65
32	1	IV9D0032	13,40
40	1	IV9D0040	14,35
50	1	IV9D0050	16,80
65	1	IV9D0065	24,75
80	1	IV9D0080	32,65
100	1	IV9D0100	44,60

PRESS **FITTING** - PERFIL M

O prensado mecânico é um sistema de montagem muito simples e rápido. Com aplicação em vários setores de atividade como o civil, industrial e naval.

As vantagens do sistema prensado são:

- Confiança e segurança
- Sem riscos de incêndio durante a instalação
- Alta resistência a corrosão

Os diâmetros disponíveis na gama ATUSA vai desde 15 mm. a 108 mm. quer em aço inoxidável como no aço carbono.





PRESS
FITTING

PRESS
FITTING

ACESSÓRIOS PRESS EM AÇO INOXIDÁVEL

CURVA 45° F/F

Ø mm		COD.	€
15	350 10	P0410015	5,20
18	300 10	P0410018	6,35
22	150 10	P0410022	7,40
28	120 5	P0410028	9,05
35	120 5	P0410035	10,85
42	80 2	P0410042	16,85
54	40 2	P0410054	22,20
76,1	12 1	P0410076	65,95
88,9	5 1	P0410088	77,70
108	2 1	P04100A0	102,60

CURVA 45° M/F

Ø mm		COD.	€
15	400 10	P40W0015	6,80
18	350 10	P40W0018	6,80
22	150 10	P40W0022	7,10
28	120 5	P40W0028	8,55
35	120 5	P40W0035	10,65
42	80 2	P40W0042	16,55
54	40 2	P40W0054	21,10
76,1	12 1	P40W0076	57,00
88,9	5 1	P40W0088	72,40
108	2 1	P40W00A0	97,85

CURVA 90° F/F

Ø mm		COD.	€
15	300 10	P0020015	4,90
18	250 10	P0020018	5,60
22	150 10	P0020022	6,25
28	175 5	P0020028	8,10
35	100 5	P0020035	12,85
42	50 2	P0020042	19,95
54	30 2	P0020054	27,65
76,1	10 1	P0020076	64,90
88,9	5 1	P0020088	81,45
108	2 1	P00200A0	103,35

CURVA 90° M/F

Ø mm		COD.	€
15	300 10	P01W0015	5,15
18	250 10	P01W0018	5,70
22	150 10	P01W0022	6,60
28	175 5	P01W0028	8,45
35	100 5	P01W0035	12,35
42	50 2	P01W0042	19,55
54	30 2	P01W0054	27,50
76,1	10 1	P01W0076	62,65
88,9	5 1	P01W0088	76,60
108	2 1	P01W00A0	107,25

JOELHO 90° ROSCA MACHO

Ø mm		COD.	€
15 x 1/2"	220 10	P92M0153	9,75
18 x 1/2"	200 10	P92M0183	12,50
22 x 3/4"	150 10	P92M0224	15,75
28 x 1"	100 5	P92M0285	17,15
35 x 1 1/4"	60 5	P92M0356	23,95

JOELHO 90° SOLDADO ROSCA MACHO

Ø mm		COD.	€
15 x 1/2"	220 10	P93M0153	9,75
18 x 1/2"	200 10	P93M0183	12,50
22 x 3/4"	150 10	P93M0224	15,75
28 x 1"	100 5	P93M0285	17,15
35 x 1 1/4"	60 5	P93M0356	23,95
42 x 1 1/2"	30 2	P93M0427	34,65
54 x 2"	12 2	P93M0548	44,00

JOELHO 90° ROSCA FÊMEA

Ø mm		COD.	€
15 x 1/2"	220 10	P92F0153	9,75
18 x 1/2"	200 10	P92F0183	10,85
22 x 3/4"	150 10	P92F0224	14,75
35 x 1 1/4"	60 5	P92F0356	28,40

JOELHO 90° SOLDADO ROSCA FÊMEA

Ø mm		COD.	€
15 x 1/2"	220 10	P93F0153	9,75
18 x 1/2"	200 10	P93F0183	10,85
22 x 3/4"	150 10	P93F0224	14,75
28 x 1/2"	100 5	P93F0283	19,45
28 x 1"	80 5	P93F0285	17,35
35 x 1 1/4"	50 5	P93F0356	28,40



TÊ

Ø mm		COD.	€
15	250 10	P130M015	8,35
18	200 10	P130M018	9,20
22	120 10	P130M022	10,65
28	75 5	P130M028	12,25
35	75 5	P130M035	15,70



TÊ SOLDADO

Ø mm		COD.	€
15	250 10	P1300015	8,35
18	200 10	P1300018	9,20
22	150 10	P1300022	10,65
28	75 5	P1300028	13,05
35	75 5	P1300035	15,70
42	50 2	P1300042	20,65
54	30 2	P1300054	26,40
76,1	10 1	P1300076	112,30
88,9	10 1	P1300088	123,35
108	4 1	P13000A0	149,70



TÊ REDUÇÃO

Ø mm		COD.	€
18 x 15 x 18	180 10	P13R1815	9,75
22 x 15 x 22	150 10	P13R2215	9,90
22 x 18 x 22	150 10	P13R2218	10,45
28 x 15 x 28	100 5	P13R2815	10,65
28 x 18 x 28	100 5	P13R2818	12,30
28 x 22 x 28	100 5	P13R2822	12,50
35 x 15 x 35	100 5	P13R3515	13,50
35 x 18 x 35	90 5	P13R3518	14,45
35 x 22 x 35	85 5	P13R3522	13,80
35 x 28 x 35	80 5	P13R3528	15,85
42 x 22 x 42	70 2	P13R4222	18,65
42 x 28 x 42	70 2	P13R4228	18,80
42 x 35 x 42	70 2	P13R4235	20,65
54 x 22 x 54	36 2	P13R5422	23,85
54 x 28 x 54	36 2	P13R5428	24,30
54 x 35 x 54	36 2	P13R5435	25,85
54 x 42 x 54	36 2	P13R5442	25,30
76,1 x 22 x 76,1	8 1	P13R7622	87,20
76,1 x 28 x 76,1	8 1	P13R7628	92,70
76,1 x 35 x 76,1	8 1	P13R7635	100,45
76,1 x 42 x 76,1	8 1	P13R7642	105,80
76,1 x 54 x 76,1	8 1	P13R7654	115,95
88,9 x 22 x 88,9	5 1	P13R8822	100,10
88,9 x 28 x 88,9	5 1	P13R8828	105,45
88,9 x 35 x 88,9	5 1	P13R8835	105,45
88,9 x 42 x 88,9	5 1	P13R8842	117,15
88,9 x 54 x 88,9	5 1	P13R8854	117,90
88,9 x 76,1 x 88,9	6 1	P13R8876	127,30
108 x 22 x 108	6 1	P13RA022	112,15
108 x 28 x 108	6 1	P13RA028	113,40
108 x 35 x 108	6 1	P13RA035	112,15
108 x 42 x 108	6 1	P13RA042	136,55
108 x 54 x 108	6 1	P13RA054	142,15
108 x 76,1 x 108	6 1	P13RA076	142,60
108 x 88,9 x 108	5 1	P13RA088	164,85



TÊ ROSCA FÊMEA

Ø mm		COD.	€
15 x 1/2" x 15	250 10	P136M153	11,60
22 x 1/2" x 22	150 10	P136M223	11,20
22 x 3/4" x 22	150 10	P136M224	14,25
28 x 1/2" x 28	75 5	P136M283	13,75
28 x 3/4" x 28	75 5	P136M284	18,35
35 x 1/2" x 35	75 5	P136M353	20,70
35 x 3/4" x 35	75 5	P136M354	19,85



TÊ SOLDADO ROSCA FEMÊA

Ø mm		COD.	€
15 x 1/2" x 15	250 10	P1360153	11,60
18 x 1/2" x 18	200 10	P1360183	11,80
18 x 3/4" x 18	200 10	P1360184	12,75
22 x 1/2" x 22	150 10	P1360223	11,20
22 x 3/4" x 22	150 10	P1360224	14,25
28 x 1/2" x 28	75 5	P1360283	13,75
28 x 3/4" x 28	75 5	P1360284	18,35
35 x 1/2" x 35	75 5	P1360353	20,70
35 x 3/4" x 35	75 5	P1360354	19,85
42 x 1/2" x 42	50 2	P1360423	21,40
42 x 3/4" x 42	50 2	P1360424	20,55
54 x 1/2" x 54	30 2	P1360543	24,70
54 x 3/4" x 54	30 2	P1360544	25,65
54 x 2" x 54	30 2	P1360548	43,75
76,1 x 3/4" x 76,1	10 1	P1360764	95,50
76,1 x 2" x 76,1	10 1	P1360768	105,35
88,9 x 3/4" x 88,9	10 1	P1360884	104,40
88,9 x 2" x 88,9	10 1	P1360888	109,90
108 x 3/4" x 108	6 1	P1360A04	135,15
108 x 2" x 108	4 1	P1360A08	140,70

UNIÃO REDUÇÃO M/F

Ø mm			COD.	€
18 x 15	500	10	P2401815	4,25
22 x 15	350	10	P2402215	5,85
22 x 18	300	10	P2402218	5,10
28 x 15	250	5	P2402815	7,45
28 x 18	250	5	P2402818	7,45
28 x 22	250	5	P2402822	6,05
35 x 15	150	5	P2403515	17,45
35 x 18	150	5	P2403518	17,45
35 x 22	150	5	P2403522	7,55
35 x 28	125	5	P2403528	7,55
42 x 15	100	2	P2404215	25,65
42 x 18	100	2	P2404218	19,45
42 x 22	100	2	P2404222	17,00
42 x 28	100	2	P2404228	18,05
42 x 35	100	2	P2404235	10,40
54 x 15	100	2	P2405415	24,35
54 x 18	100	2	P2405418	27,95
54 x 22	100	2	P2405422	19,55
54 x 28	100	2	P2405428	20,65
54 x 35	100	2	P2405435	25,90
54 x 42	100	2	P2405442	13,25
76,1 x 42	25	1	P2407642	43,15
76,1 x 54	25	1	P2407654	38,45
88,9 x 54	15	1	P2408854	42,65
88,9 x 76,1	15	1	P2408876	49,35
108 x 54	10	1	P240A054	57,95
108 x 76,1	10	1	P240A076	75,85
108 x 88,9	10	1	P240A088	63,45

UNIÃO

Ø mm			COD.	€
15	500	10	P2700015	4,00
18	400	10	P2700018	4,00
22	300	10	P2700022	4,35
28	300	5	P2700028	4,85
35	100	5	P2700035	6,65
42	70	2	P2700042	8,75
54	70	2	P2700054	10,85
76,1	22	1	P2700076	38,95
88,9	12	1	P2700088	44,10
108	5	1	P27000A0	61,65

UNIÃO LONGA

Ø mm			COD.	€
15	350	10	P27L0015	5,95
18	300	10	P27L0018	6,50
22	180	10	P27L0022	8,30
28	250	5	P27L0028	10,05
35	120	5	P27L0035	12,00
42	70	2	P27L0042	13,25
54	60	2	P27L0054	19,40
76,1	12	1	P27L0076	103,35
88,9	9	1	P27L0088	117,00
108	5	1	P27L00A0	141,90

CASQUILHO 2 PEÇAS COM JUNTA PLANA

Ø mm			COD.	€
15 x 1/2"	300	10	P27N0153	12,50
15 x 3/4"	300	10	P27N0154	16,20
18 x 1/2"	200	10	P27N0183	13,95
18 x 3/4"	200	10	P27N0184	11,00
22 x 1"	150	10	P27N0225	14,75
28 x 1 1/4"	100	5	P27N0286	14,65
35 x 1 1/2"	80	5	P27N0357	38,00
76,1 x 2 1/2"	15	1	P27N0769	75,85

JUNÇÃO CÔNICA 3 PEÇAS

Ø mm			COD.	€
15	200	5	P3300015	23,25
18	150	5	P3300018	23,25
22	100	5	P3300022	29,65
28	75	2	P3300028	37,75
35	50	2	P3300035	50,15
42	30	2	P3300042	92,25
54	20	2	P3300054	92,25

JOELHO SOLDADO ROSCA FÊMEA COM PATER

Ø mm			COD.	€
15 x 1/2"	200	10	P92E0153	10,50
18 x 1/2"	150	10	P92E0183	12,20
22 x 3/4"	120	10	P92E0224	15,80
28 x 1"	75	5	P92E0285	15,60

TAMPÃO

Ø mm			COD.	€
15	500	10	P3000015	7,55
18	400	10	P3000018	8,55
22	300	10	P3000022	9,30
28	200	5	P3000028	11,45
35	100	5	P3000035	13,00
42	80	2	P3000042	17,15
54	60	2	P3000054	22,50
76,1	25	1	P3000076	43,75
88,9	15	1	P3000088	49,70
108	10	1	P30000A0	68,70



CASQUILHO 3 PEÇAS ROSCA MACHO

Ø mm			COD.	€
15 x 1/2"	200	10	P33M0153	20,20
15 x 3/4"	200	10	P33M0154	24,65
18 x 1/2"	150	10	P33M0183	21,55
18 x 3/4"	150	10	P33M0184	30,75
22 x 1/2"	100	5	P33M0223	31,25
22 x 3/4"	100	5	P33M0224	30,00
22 x 1"	100	5	P33M0225	33,20
28 x 1"	75	5	P33M0285	36,35
35 x 1 1/4"	50	5	P33M0356	46,65
42 x 1 1/2"	30	2	P33M0427	48,65
54 x 2"	20	2	P33M0548	83,80



CASQUILHO 3 PEÇAS ROSCA FÊMEA

Ø mm			COD.	€
15 x 1/2"	200	10	P33F0153	20,10
18 x 1/2"	150	10	P33F0183	25,70
22 x 3/4"	100	5	P33F0224	31,60
28 x 1"	75	5	P33F0285	33,35
35 x 1 1/4"	50	5	P33F0356	44,60
42 x 1 1/2"	30	2	P33F0427	46,90
54 x 2"	20	2	P33F0548	84,85



CASQUILHO ROSCA MACHO

Ø mm			COD.	€
15 x 3/8"	300	10	P27M0152	7,40
15 x 1/2"	300	10	P27M0153	6,65
15 x 3/4"	300	10	P27M0154	7,85
18 x 1/2"	250	10	P27M0183	8,15
18 x 3/4"	250	10	P27M0184	8,50
22 x 1/2"	250	10	P27M0223	7,65
22 x 3/4"	200	10	P27M0224	9,75
22 x 1"	200	10	P27M0225	10,70
28 x 3/4"	150	5	P27M0284	12,15
28 x 1"	120	5	P27M0285	13,60
28 x 1 1/4"	100	5	P27M0286	16,85
35 x 1"	100	5	P27M0355	15,45
35 x 1 1/4"	100	5	P27M0356	16,75
35 x 1 1/2"	100	5	P27M0357	22,05
42 x 1 1/4"	60	2	P27M0426	21,50
42 x 1 1/2"	50	2	P27M0427	22,05
54 x 1 1/2"	40	2	P27M0547	26,70
54 x 2"	30	2	P27M0548	29,05
76,1 x 2 1/2"	12	1	P27M0769	96,90
88,9 x 3"	10	1	P27M099B	108,60



CASQUILHO ROSCA FÊMEA

Ø mm			COD.	€
15 x 1/2"	300	10	P27F0153	8,15
15 x 3/4"	300	10	P27F0154	8,70
18 x 1/2"	250	10	P27F0183	8,60
18 x 3/4"	250	10	P27F0184	8,85
22 x 1/2"	200	10	P27F0223	9,00
22 x 3/4"	200	10	P27F0224	10,50
22 x 1"	200	10	P27F0225	12,30
28 x 3/4"	125	5	P27F0284	11,90
28 x 1"	120	5	P27F0285	15,75
28 x 1 1/4"	100	5	P27F0286	19,05
35 x 1"	100	5	P27F0355	16,50
35 x 1 1/4"	100	5	P27F0356	17,45
35 x 1 1/2"	100	5	P27F0357	22,80
42 x 1 1/4"	60	2	P27F0426	19,10
42 x 1 1/2"	50	2	P27F0427	24,80
54 x 1 1/2"	40	2	P27F0547	28,10
54 x 2"	30	2	P27F0548	37,65

UNIÃO DE CRUZAMENTO

Ø mm		COD.	€
15	250 10	P0860015	13,50
18	200 10	P0860018	13,80
22	150 10	P0860022	15,90

CURVA DE AJUSTE 15°

Ø mm		COD.	€
28	90 5	PE150028	12,20
35	65 5	PE150035	15,15
42	30 2	PE150042	26,00
54	26 2	PE150054	31,55

CURVA DE AJUSTE 30°

Ø mm		COD.	€
28	80 5	PE300028	10,95
35	60 5	PE300035	20,80
42	28 2	PE300042	27,50
54	24 2	PE300054	34,20

CURVA DE AJUSTE 60°

Ø mm		COD.	€
28	80 5	PE600028	12,20
35	55 5	PE600035	22,10
42	26 2	PE600042	28,30
54	22 2	PE600054	37,15

CURVA DE AJUSTE 90°

Ø mm		COD.	€
15	150 10	PE900015	8,45
18	120 10	PE900018	9,05
22	100 10	PE900022	9,55
28	75 5	PE900028	11,15
35	50 5	PE900035	17,60
42	24 2	PE900042	22,90
54	20 2	PE900054	29,20

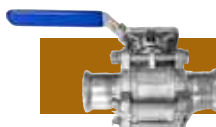
VÁLVULA ESFERA PASSAGEM TOTAL

Ø mm		COD.	€
35	1 1	PV300035	Consultar
42	1 1	PV300042	Consultar
54	1 1	PV300054	Consultar
76,1	1 1	PV300076	Consultar
88,9	1 1	PV300088	Consultar
108	1 1	PV3000A0	Consultar

FLANGE PN16

Ø mm		COD.	€
15	1 1	P3200015	42,85
18	1 1	P3200018	44,85
22	1 1	P3200022	50,20
28	1 1	P3200028	67,00
35	1 1	P3200035	89,20
42	1 1	P3200042	79,75
54	1 1	P3200054	105,20
76,1	1 1	P3200076	153,35
88,9	1 1	P3200088	178,50
108	1 1	P32000A0	207,30

ACESSÓRIOS PRESS EM AÇO CARBONO

CURVA 45° F/F

Ø mm			COD.	€
15	350	10	Q0410015	3,95
18	300	10	Q0410018	4,15
22	150	10	Q0410022	4,25
28	120	5	Q0410028	5,65
35	120	5	Q0410035	10,60
42	80	2	Q0410042	13,25
54	40	2	Q0410054	15,25
76,1	12	1	Q0410076	31,50
88,9	5	1	Q0410088	43,80
108	2	1	Q04100A0	57,80

CURVA 45° M/F

Ø mm			COD.	€
15	400	10	Q40W0015	3,70
18	350	10	Q40W0018	3,90
22	150	10	Q40W0022	4,00
28	120	5	Q40W0028	5,50
35	120	5	Q40W0035	10,20
42	80	2	Q40W0042	13,30
54	40	2	Q40W0054	16,05
76,1	12	1	Q40W0076	29,85
88,9	5	1	Q40W0088	44,85
108	2	1	Q40W00A0	58,10

CURVA 90° F/F

Ø mm			COD.	€
15	300	10	Q0020015	3,60
18	250	10	Q0020018	3,95
22	150	10	Q0020022	4,40
28	175	5	Q0020028	5,45
35	100	5	Q0020035	11,95
42	50	2	Q0020042	18,30
54	30	2	Q0020054	21,00
76,1	10	1	Q0020076	33,70
88,9	5	1	Q0020088	46,50
108	2	1	Q00200A0	68,75

CURVA 90° M/F

Ø mm			COD.	€
15	300	10	Q01W0015	3,45
18	250	10	Q01W0018	3,90
22	150	10	Q01W0022	4,20
28	175	5	Q01W0028	5,25
35	100	5	Q01W0035	11,05
42	50	2	Q01W0042	18,60
54	30	2	Q01W0054	21,90
76,1	10	1	Q01W0076	34,05
88,9	5	1	Q01W0088	53,40
108	2	1	Q01W00A0	68,80

CURVA 90° ROSCA MACHO

Ø mm			COD.	€
15 x 3/8"	250	10	Q0010152	10,20
15 x 1/2"	250	10	Q0010153	10,35
18 x 1/2"	200	10	Q0010183	11,40
22 x 3/4"	100	10	Q0010224	13,15
28 x 1"	75	5	Q0010285	16,35
35 x 1 1/4"	30	5	Q0010356	25,05
42 x 1 1/2"	20	2	Q0010427	39,15
54 x 2"	12	2	Q0010548	51,25

TÊ

Ø mm			COD.	€
15	250	10	Q1300015	7,05
18	180	10	Q1300018	7,30
22	120	10	Q1300022	7,75
28	100	5	Q1300028	9,15
35	75	5	Q1300035	15,45
42	50	2	Q1300042	22,75
54	30	2	Q1300054	25,60
76,1	8	1	Q1300076	69,30
88,9	5	1	Q1300088	79,50
108	4	1	Q13000A0	102,20

TÊ ROSCA FÊMEA

Ø mm		COD.	€
15 x 1/2" x 15	250 10	Q1360153	11,15
18 x 1/2" x 18	200 10	Q1360183	11,30
18 x 3/4" x 18	200 10	Q1360184	8,70
22 x 1/2" x 22	150 10	Q1360223	10,75
22 x 3/4" x 22	150 10	Q1360224	13,95
28 x 1/2" x 28	75 5	Q1360283	12,65
28 x 3/4" x 28	75 5	Q1360284	12,80
35 x 1/2" x 35	75 5	Q1360353	14,30
35 x 3/4" x 35	75 5	Q1360354	18,70
42 x 1/2" x 42	50 2	Q1360423	21,85
42 x 3/4" x 42	50 2	Q1360424	24,10
54 x 1/2" x 54	30 2	Q1360543	24,05
54 x 3/4" x 54	30 2	Q1360544	25,35
76,1 x 3/4" x 76,1	10 1	Q1360764	74,20
88,9 x 3/4" x 88,9	10 1	Q1360884	89,25
108 x 3/4" x 108	6 1	Q1360A04	115,80

TÊ REDUÇÃO

Ø mm		COD.	€
18 x 15 x 18	180 10	Q13R1815	8,10
22 x 15 x 22	150 10	Q13R2215	8,25
22 x 18 x 22	150 10	Q13R2218	8,90
28 x 15 x 28	100 5	Q13R2815	11,20
28 x 18 x 28	100 5	Q13R2818	10,90
28 x 22 x 28	100 5	Q13R2822	12,20
35 x 15 x 35	100 5	Q13R3515	15,50
35 x 18 x 35	90 5	Q13R3518	16,80
35 x 22 x 35	85 5	Q13R3522	16,90
35 x 28 x 35	80 5	Q13R3528	17,20
42 x 22 x 42	70 2	Q13R4222	21,45
42 x 28 x 42	70 2	Q13R4228	22,00
42 x 35 x 42	70 2	Q13R4235	23,30
54 x 22 x 54	36 2	Q13R5422	25,30
54 x 28 x 54	36 2	Q13R5428	26,20
54 x 35 x 54	36 2	Q13R5435	26,45
54 x 42 x 54	36 2	Q13R5442	27,90
76,1 x 22 x 76,1	8 1	Q13R7622	61,60
76,1 x 28 x 76,1	8 1	Q13R7628	62,75
76,1 x 35 x 76,1	8 1	Q13R7635	62,75
76,1 x 42 x 76,1	8 1	Q13R7642	63,85
76,1 x 54 x 76,1	8 1	Q13R7654	68,05
88,9 x 28 x 88,9	5 1	Q13R8828	82,45
88,9 x 35 x 88,9	5 1	Q13R8835	84,00
88,9 x 42 x 88,9	5 1	Q13R8842	78,55
88,9 x 54 x 88,9	5 1	Q13R8854	76,60
88,9 x 76,1 x 88,9	5 1	Q13R8876	88,15
108 x 28 x 108	6 1	Q13RA028	103,55
108 x 35 x 108	6 1	Q13RA035	106,25
108 x 42 x 108	6 1	Q13RA042	105,40
108 x 54 x 108	6 1	Q13RA054	103,20
108 x 76,1 x 108	6 1	Q13RA076	102,85
108 x 88,9 x 108	5 1	Q13RA088	98,90

CASQUILHO 2 PEÇAS COM JUNTA PLANA

Ø mm		COD.	€
15 x 3/4"	300 10	Q27N0154	8,60
18 x 3/4"	200 10	Q27N0184	8,85
22 x 1"	150 10	Q27N0225	9,85
28 x 1 1/4"	100 5	Q27N0286	12,25
35 x 1 1/2"	80 5	Q27N0357	17,40
42 x 1 3/4"	50 2	Q27N042U	36,50
54 x 2 3/8"	30 2	Q27N054T	41,10

UNIÃO LONGA

Ø mm		COD.	€
15	350 10	Q27L0015	3,30
18	300 10	Q27L0018	3,80
22	180 10	Q27L0022	3,95
28	250 5	Q27L0028	5,00
35	120 5	Q27L0035	9,20
42	70 2	Q27L0042	10,60
54	60 2	Q27L0054	11,70
76,1	12 1	Q27L0076	36,25
88,9	9 1	Q27L0088	43,20
108	5 1	Q27L00A0	48,20

UNIÃO

Ø mm		COD.	€
15	500 10	Q2700015	3,05
18	400 10	Q2700018	3,40
22	300 10	Q2700022	3,35
28	300 5	Q2700028	3,80
35	100 5	Q2700035	6,75
42	70 2	Q2700042	8,00
54	70 2	Q2700054	8,95
76,1	22 1	Q2700076	23,50
88,9	12 1	Q2700088	25,60
108	8 1	Q27000A0	42,40



UNIÃO REDUÇÃO M/F

Ø mm			COD.	€
18 x 15	500	10	Q2401815	3,35
22 x 15	350	10	Q2402215	3,50
22 x 18	300	10	Q2402218	3,60
28 x 15	250	5	Q2402815	4,80
28 x 18	250	5	Q2402818	4,70
28 x 22	250	5	Q2402822	4,00
35 x 15	150	5	Q2403515	9,85
35 x 18	150	5	Q2403518	10,05
35 x 22	150	5	Q2403522	6,15
35 x 28	125	5	Q2403528	4,55
42 x 18	100	5	Q2404218	12,80
42 x 22	100	5	Q2404222	12,45
42 x 28	100	2	Q2404228	10,30
42 x 35	100	2	Q2404235	8,35
54 x 18	100	2	Q2405418	19,70
54 x 22	100	2	Q2405422	24,65
54 x 28	100	2	Q2405428	20,35
54 x 35	100	2	Q2405435	21,35
54 x 42	100	2	Q2405442	13,75
76,1 x 42	25	1	Q2407642	34,55
76,1 x 54	25	1	Q2407654	28,40
88,9 x 54	15	1	Q2408854	33,95
88,9 x 76,1	15	1	Q2408876	38,85
108 x 54	10	1	Q240A054	70,75
108 x 76,1	10	1	Q240A076	42,95
108 x 88,9	10	1	Q240A088	52,60



TAMPÃO

Ø mm			COD.	€
15	500	10	Q3000015	4,80
18	400	10	Q3000018	5,25
22	300	10	Q3000022	5,50
28	200	5	Q3000028	6,65
35	100	5	Q3000035	7,90
42	80	2	Q3000042	11,95
54	60	2	Q3000054	14,65
76,1	25	1	Q3000076	25,20
88,9	15	1	Q3000088	30,80
108	10	1	Q3000A0	48,95



FLANGE PN16

Ø mm			COD.	€
22	1	1	Q3200022	37,55
28	1	1	Q3200028	41,95
35	1	1	Q3200035	53,05
42	1	1	Q3200042	63,50
54	1	1	Q3200054	69,25
76,1	1	1	Q3200076	85,45
88,9	1	1	Q3200088	90,70
108	1	1	Q3200A0	130,10



CASQUILHO 3 PEÇAS ROSCA MACHO

Ø mm			COD.	€
15 x 1/2"	200	10	Q33M0153	16,40
15 x 3/4"	200	10	Q33M0154	18,65
18 x 1/2"	150	10	Q33M0183	18,55
18 x 3/4"	150	10	Q33M0184	20,95
22 x 1/2"	100	10	Q33M0223	21,35
22 x 3/4"	100	10	Q33M0224	20,95
22 x 1"	100	10	Q33M0225	25,70
28 x 1"	75	5	Q33M0285	24,65
35 x 1 1/4"	50	5	Q33M0356	32,40
42 x 1 1/2"	30	2	Q33M0427	50,50
54 x 2"	20	2	Q33M0548	115,85



CASQUILHO 3 PEÇAS ROSCA FÊMEA

Ø mm			COD.	€
15 x 1/2"	200	10	Q33F0153	17,35
18 x 1/2"	150	10	Q33F0183	18,05
22 x 3/4"	100	10	Q33F0224	21,75
22 x 1"	100	10	Q33F0225	25,80
28 x 1"	75	5	Q33F0285	31,55
35 x 1 1/4"	50	5	Q33F0356	40,60
42 x 1 1/2"	30	2	Q33F0427	68,05
54 x 2"	20	2	Q33F0548	80,50

CASQUILHO ROSCA MACHO

Ø mm			COD.	€
15 x 3/8"	300	10	Q27M0152	6,35
15 x 1/2"	300	10	Q27M0153	6,35
15 x 3/4"	300	10	Q27M0154	7,90
18 x 1/2"	250	10	Q27M0183	7,05
18 x 3/4"	250	10	Q27M0184	7,95
22 x 1/2"	250	10	Q27M0223	6,90
22 x 3/4"	200	10	Q27M0224	7,80
22 x 1"	200	10	Q27M0225	9,70
28 x 3/4"	150	5	Q27M0284	9,40
28 x 1"	120	5	Q27M0285	9,75
35 x 1"	100	5	Q27M0355	12,80
35 x 1 1/4"	100	5	Q27M0356	13,25
35 x 1 1/2"	100	5	Q27M0357	14,50
42 x 1 1/4"	60	2	Q27M0426	20,30
42 x 1 1/2"	50	2	Q27M0427	15,50
54 x 2"	30	2	Q27M0548	21,65
76,1 x 2 1/2"	12	1	Q27M0769	67,45
88,9 x 3"	10	1	Q27M099B	99,35
108 x 4"	5	1	Q27MA00D	100,70

CASQUILHO ROSCA FÊMEA

Ø mm			COD.	€
15 x 1/2"	350	10	Q27F0153	7,30
18 x 1/2"	300	10	Q27F0183	7,25
18 x 3/4"	250	10	Q27F0184	8,60
22 x 1/2"	200	10	Q27F0223	8,75
22 x 3/4"	200	10	Q27F0224	8,85
22 x 1"	200	10	Q27F0225	10,50
28 x 3/4"	125	5	Q27F0284	11,15
28 x 1"	150	5	Q27F0285	10,65
35 x 1"	60	5	Q27F0355	12,30
35 x 1 1/4"	75	5	Q27F0356	10,90
42 x 1 1/2"	50	2	Q27F0427	18,20
54 x 2"	30	2	Q27F0548	21,65

ADAPTADOR ROSCA FÊMEA

Ø mm			COD.	€
15 x 1/2"	350	10	Q60F0153	4,55
18 x 1/2"	300	10	Q60F0183	4,85
22 x 1/2"	200	10	Q60F0223	5,40
18 x 3/4"	300	10	Q60F0184	5,45
22 x 3/4"	200	10	Q60F0224	6,60

ADAPTADOR ROSCA MACHO

Ø mm			COD.	€
15 x 1/2"	350	10	Q60M0153	5,30
18 x 1/2"	300	10	Q60M0183	5,60
15 x 3/4"	350	10	Q60M0154	6,55
18 x 3/4"	300	10	Q60M0184	6,25
22 x 3/4"	200	10	Q60M0224	7,80

UNIÃO DE CRUZAMENTO

Ø mm			COD.	€
15	200	10	Q0850015	5,25
18	150	10	Q0850018	5,05
22	100	10	Q0850022	6,55
28	80	5	Q0850028	7,15

CURVA DE AJUSTE 90°

Ø mm			COD.	€
15	150	10	QE900015	Consultar
18	120	10	QE900018	Consultar
22	100	10	QE900022	Consultar
28	75	5	QE900028	Consultar
35	50	5	QE900035	Consultar
42	24	2	QE900042	Consultar
54	20	2	QE900054	Consultar

ACESSÓRIOS



O-RING EM EPDM (NEGRO)

Ø mm		COD.	€
15	10	9000N015	*
18	10	9000N018	*
22	10	9000N022	*
28	10	9000N028	*
35	10	9000N035	*
42	10	9000N042	*
54	10	9000N054	*
76,1	1	9000N076	*
88,9	1	9000N088	*
108	1	9000N0A0	*

CARACTERÍSTICAS TÉCNICAS

Temp: -10 °C - +110 °C (120 °C)
Diâmetro: Ø12 - Ø108 mm.

APLICAÇÕES

- Água potável
- Água macia
- Água da chuva
- Instalações de aquecimento
- Sistemas de circulação
- Sistemas de Segurança Contra-Incêndios



O-RING EM FPM (VERDE) - DIN ISO 1629

Ø mm		COD.	€
15	10	9000V015	*
18	10	9000V018	*
22	10	9000V022	*
28	10	9000V028	*
35	10	9000V035	*
42	10	9000V042	*
54	10	9000V054	*
76,1	1	9000V076	*
88,9	1	9000V088	*
108	1	9000V0A0	*

CARACTERÍSTICAS TÉCNICAS

Temp: -30° C a 160° C (200° C).
Diâmetro: Ø15 - Ø108 mm.

APLICAÇÕES

- Sistemas de ar comprimido
- Instalações de vapor e condensados
- Instalações de solar
- Instalações de refrigeração
- Hidrocarbonetos, exceto gasóleo
- Óleo mineral, vegetal e sintético



O-RING EM FPM (VERMELHO) - DIN ISO 1629

Ø mm		COD.	€
15	10	9000R015	*
18	10	9000R018	*
22	10	9000R022	*
28	10	9000R028	*
35	10	9000R035	*
42	10	9000R042	*
54	10	9000R054	*
76,1	1	9000R076	*
88,9	1	9000R088	*
108	1	9000R0A0	*

CARACTERÍSTICAS TÉCNICAS

Temp: -30° C a 160° C (200° C).
Diâmetro: Ø15 - Ø108 mm.

APLICAÇÕES

- Sistemas de ar comprimido
- Óleo mineral, vegetal e sintético
- Gorduras e aplicações industriais
- Hidrocarbonetos, exceto gasóleo pesado
- Gases liquefeitos (GPL)

TUBO

Tubagem 304L:

Tubagem Inoxidável EN 10312, na sua variante de Aço Inoxidável A-304L, com juntas de EPDM, sendo adequada para instalações de ar comprimido, água potável fria, aquecimento e climatização (até temperaturas de 110 °C). Não compatível com água de POÇO.

Tubagem 316L:

Tubagem Inoxidável EN 10312, na sua variante de Aço Inoxidável A-316L, com juntas de EPDM, sendo adequada para instalações de ar comprimido, aquecimento e climatização, condensados e vapor, água potável e água quente sanitária (até temperaturas de 110 °C) conforme especificações DVGW. Não compatível com água de POÇO.

Em instalações de AQS, a quantidade de cloro combinado residual nunca deve superar 2 mg/l e o cloro livre residual não deve superar 1 mg/l. A concentração máxima admissível de cloretos é de 250 ppm.

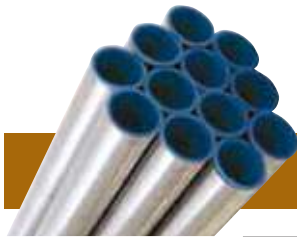

TUBO EM AÇO INOXIDÁVEL

Ø (mm)	INOX 304L (1.4307) EN-10312-1			INOX 316L (1.4404) EN-10312-1			INOX 316L (1.4404) DVGW		
	COD.	Espessura (mm)	Comprim. (m)	COD.	Espessura (mm)	Comprim. (m)	COD.	Espessura (mm)	Comprim. (m)
15	S0934015	0,6	5	S0931015	0,6	5	S0930015	1,0	6
18	S0934018	0,7	5	S0931018	0,7	5	S0930018	1,0	6
22	S0934022	0,7	5	S0931022	0,7	5	S0930022	1,2	6
28	S0934028	0,8	5	S0931028	0,8	5	S0930028	1,2	6
35	S0934035	1,0	5	S0931035	1,0	5	S0930035	1,5	6
42	S0934042	1,2	5	S0931042	1,2	5	S0930042	1,5	6
54	S0934054	1,2	5	S0931054	1,2	5	S0930054	1,5	6
76,1	S0934076	2,0	6				S0930076	2,0	6
88,9	S0934088	2,0	6				S0930088	2,0	6
108	S09340A0	2,0	6				S09300A0	2,0	6



TUBO DE AÇO GALVANIZADO - EN 10305-3

Ø (mm)	GALVANIZAÇÃO EXTERIOR			GALVANIZAÇÃO INTERIOR E EXTERIOR		
	COD.	Espessura (mm)	Comprimento (m)	COD.	Espessura (mm)	Comprimento (m)
15	Q0930015	1,2	6	Q0932015	1,2	6
18	Q0930018	1,2	6	Q0932018	1,2	6
22	Q0930022	1,2	6	Q0932022	1,2	6
28	Q0930028	1,5	6	Q0932028	1,5	6
35	Q0930035	1,5	6	Q0932035	1,5	6
42	Q0930042	1,5	6	Q0932042	1,5	6
54	Q0930054	1,5	6	Q0932054	1,5	6
76,1	Q0930076	2,0	6	Q0932076	2,0	6
88,9	Q0930088	2,0	6	Q0932088	2,0	6
108	Q09300A0	2,0	6	Q09320A0	2,0	6

SISTEMAS DE FIXAÇÃO



ABRAÇADEIRA SIMPLES AISI-304

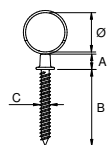

Ø mm	A mm	B mm	C mm		COD.	€
15	7	35	4,8	90	PF4S0015	0,80
18	7	35	4,8	60	PF4S0018	0,90
22	7	35	4,8	40	PF4S0022	1,05
28	7	35	4,8	20	PF4S0028	1,75



ABRAÇADEIRA "PLUS" AISI-304

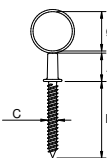

Ø mm	A mm	B mm	C mm		COD.	€
15	13	35	4,8	75	PF4P0015	0,95
18	13	35	4,8	50	PF4P0018	1,00



ABRAÇADEIRA ROSCA MACHO AISI-304

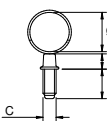

Ø mm	A mm	B mm	C mm		COD.	€
15	6	12	6	90	PF4M0015	0,95
18	6	12	6	60	PF4M0018	1,20
22	6	12	6	40	PF4M0022	1,35
28	6	12	6	20	PF4M0028	2,10



ABRAÇADEIRA ROSCA FÊMEA AISI-304

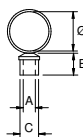

Ø mm	A mm	B mm	C mm		COD.	€
15	6	10	12	90	PF4F0015	1,40
18	6	10	12	60	PF4F0018	1,55
22	6	10	12	40	PF4F0022	1,75
28	6	10	12	20	PF4F0028	2,35

MÁQUINA DE PRENSAR

COD.
PRG0000K



COD.
PRG0002K

CARACTERÍSTICAS	PRG0000K	PRG0002K
Bluetooth	NÃO	SIM
OLED-Display	NÃO	SIM
Relógio em tempo real (RTC)	NÃO	SIM
Sensor de pressão (HPC)	NÃO	SIM
Força de aperto	32KN	32KN
Bateria	230V	18V 4,0 Ah Li-Ion Makita
N. de prensados / Tempo de carga	-	400 (NS20)* / 22 Min
Peso com bateria / sem mordente	7,6 kg.	7,98 kg.
Cabeçal rotativo	350°	350°

MORDENTES, ADAPTADORES, ANEIS

DIMENSÕES (mm)	COD.	DESCRIÇÃO	MÁQUINA
Ø 15	PRP00015	MORDENTE STANDARD PRESS 32KN Ø15MM	PRG0000K, PRG0002K
Ø 18	PRP00018	MORDENTE STANDARD PRESS 32KN Ø18MM	PRG0000K, PRG0002K
Ø 22	PRP00022	MORDENTE STANDARD PRESS 32KN Ø22MM	PRG0000K, PRG0002K
Ø 28	PRP00028	MORDENTE STANDARD PRESS 32KN Ø28MM	PRG0000K, PRG0002K
Ø 35	PRP00035	MORDENTE STANDARD PRESS 32KN Ø35MM	PRG0000K, PRG0002K
Ø 42 y 54	PRP04254	KIT MORDENTES 3 SEGMENTOS PRESS 32KN Ø42-Ø54MM + ADAPTADOR	PRG0000K, PRG0002K
Ø 76.1	PRP00076	TENAZ PRESS 4 SEGMENTOS UAP432 Ø76.1MM	PRG0002K
Ø 88.9	PRP00088	TENAZ PRESS 4 SEGMENTOS UAP432 Ø88.9MM	PRG0002K
Ø 108	PRP00108	TENAZ PRESS 4 SEGMENTOS UAP432 Ø108MM	PRG0002K
Ø 76.1, 88.9 y 108	PRPADCAD	ADAPTADOR PARA TENAZ PRESS Ø76.1MM, Ø88.9MM E Ø108MM	-



COD.
PRP00015
PRP00018
PRP00022
PRP00028
PRP00035



COD.
PRPADCAD



COD.
PRP00076
PRP00088
PRP00108



COD.
PRP04254

CARACTERÍSTICAS TÉCNICAS

Campos de aplicação	Qualidade da Tubagem	Junta	Comentários	Aço Inoxidável	Aço Carbono
Água Potável	A-316L	EPDM	A-304 cloretos <200mg/l A-316 cloretos <250 mg/l	Adequado	Não adequado
Aquecimento	A-304 A-316L	EPDM	Dissoluções Glicol <25%, para maior percentagem usar juntas FKM/FPM.	Adequado	Adequado Tubo Zincado (Ext.)
Solar	A-316L	FKM	Temp. Máx. 160 °C, com picos de 180 °C. Circuito Primário conforme DB HE do CTE sempre em Aço Inoxidável	Adequado com junta de FKM (Verde)	Adequado para circuito secundário junta FKM (Verde). Tubo Zincado (Ext.)
Combustível (excepto gasóleo)	A-304 A-316L	FKM	Instalações Óleo-hidráulicas, incluindo Hidrocarbonetos excepto gasóleo pesado.	Adequado com junta FKM (Vermelha)	Adequado con anillo FKM (Rojo). Tubo Zinc (Ext.)
Ar comprimido (Gases Inertes)	A-304 A-316L	EPDM FKM	O sistema não é SILICON-FREE (Não usar em instalações onde seja requerido). O sistema é apto para instalações de gases inertes, não explosivos nem tóxicos (Azoto, Dióxido de Carbono, Árgon).	Adequado com EPDM Inst. Classe 1-4 (ISO 8573-1) Inst. Classe 5 usar junta FKM (Verde)	Tubo Zincado 2 faces (Ext./Int). Adequado com EPDM Inst. Classe 1-4 (ISO 8573-1). Inst. Classe 5, usar junta FKM (Verde).
Água da chuva	A-304 A-316L	EPDM	Selecionar A-304 / A-316L, dependendo da localização e condições externas da instalação.	Adequado	Não adequado
Condensado de Vapor	A-304 A-316L	FKM	Temp. Máx. 160 °C, com picos de 180 °C.	Adequado com junta de FKM (Verde).	Não adequado
Indústria	A-316L	EPDM FKM	Consultar aplicação	A pedido	A pedido
SCI (BIAs/ Sprinklers)	A-304 A-316L	EPDM	Sistema certificado SCI para riscos ligeiro e ordinários 1 a 4 (Cinemas, Teatros, Salas de Concerto, Parques Auto).	Adequado	Adequado com Tubo Zincado 2 faces (Int./Ext.)
Vácuo	A-304 A-316L	EPDM	O sistema é apto para redução de vácuo a 200 mbar de valor relativo. (redução da pressão atmosférica a -0,8 bar).	Adequado	Adequado com Tubo Zincado 2 faces (Int./Ext.)
Água de poço	A-304 A-316L	EPDM	Nunca utilizar águas de poço, nem águas de nascente, nem águas não tratadas.	Não adequado	Não adequado

ACESSÓRIOS DE **LATÃO**

A excelente resistência do latão perante a corrosão e às altas temperaturas fazem desta liga um material ideal para a distribuição e fornecimento de água.

A ATUSA, seguindo a sua política de comercializar produtos cumprindo os mais exigentes padrões de qualidade, apresenta uma ampla gama de acessórios de latão e soluções para a ligação de diferentes tipos de tubagem.





◀▶ **ATUSA**

ACESSÓRIOS
DE LATÃO

ACESSÓRIOS DE
LATÃO

ACESSÓRIOS PARA TUBO POLIETILENO SÉRIE "GORBEA"

Acessórios de latão de compressão fabricados em CW617N cumprindo a norma EN 12165.

Sistema de compressão por ROSCA EXTERNA.

Acessórios fabricados cumprindo a normativa EN 1254.4

Acessórios com certificado DVGW para uso em água potável.

Na sua instalação aconselha-se a utilização de Bainha de Reforço evitando-se assim possíveis problemas de estanquidade provenientes das deformações do tubo.

Pressão máxima de trabalho: PN 25.

Temperatura máxima de serviço 60° C.



UNIÃO DUPLA

Ø	Box		COD.	€
20	50	10	LPGRD020	6,70
25	30	10	LPGRD025	10,20
32	20	5	LPGRD032	14,10
40	12	4	LPGRD040	23,85
50	8	4	LPGRD050	34,60
63	3		LPGRD063	58,20



UNIÃO MACHO

Ø	Box		COD.	€
1/2" x 20	90	10	LPGRM320	3,85
3/4" x 25	60	10	LPGRM425	5,70
1" x 32	35	5	LPGRM532	8,80
1 1/4" x 40	20	5	LPGRM640	14,65
1 1/2" x 50	12	4	LPGRM750	21,60
2" x 63	6	3	LPGRM863	34,45



UNIÃO FÊMEA

Ø	Box		COD.	€
1/2" x 20	80	10	LPGRH320	4,25
3/4" x 25	60	10	LPGRH425	6,60
1" x 32	30	5	LPGRH532	9,20
1 1/4" x 40	20	5	LPGRH640	15,70
1 1/2" x 50	8	4	LPGRH750	23,70
2" x 63	6	3	LPGRH863	41,00



JOELHO DUPLO

Ø	Box		COD.	€
20	40	10	LPGCD020	7,60
25	20	10	LPGCD025	11,95
32	15	5	LPGCD032	17,20
40	10	5	LPGCD040	29,55
50	5		LPGCD050	45,00
63	3		LPGCD063	73,00



JOELHO MACHO

Ø	Box		COD.	€
1/2" x 20	70	10	LPGCM320	5,35
3/4" x 25	40	10	LPGCM425	8,10
1" x 32	25	5	LPGCM532	11,95
1 1/4" x 40	10	5	LPGCM640	20,25
1 1/2" x 50	10	5	LPGCM750	30,20
2" x 63	4		LPGCM863	52,05



JOELHO FÊMEA

Ø	Box		COD.	€
1/2" x 20	70	10	LPGCH320	5,60
3/4" x 25	40	10	LPGCH425	8,60
1" x 32	25	5	LPGCH532	13,00
1 1/4" x 40	10	5	LPGCH640	21,85
1 1/2" x 50	8	4	LPGCH750	32,20
2" x 63	4		LPGCH863	54,80



TÊ

Ø	Box		COD.	€
20	30	10	LPGTD020	10,85
25	20	5	LPGTD025	16,50
32	10	5	LPGTD032	24,50
40	6		LPGTD040	41,75
50	4		LPGTD050	64,00
63	3		LPGTD063	105,00



TÊ FÊMEA

Ø	Box		COD.	€
1/2" x 20	30	10	LPGTH320	8,55
3/4" x 25	20	5	LPGTH425	13,25
1" x 32	15	5	LPGTH532	19,60
1 1/4" x 40	6		LPGTH640	33,30
1 1/2" x 50	4		LPGTH750	55,00
2" x 63	3		LPGTH863	85,05



JOELHO FÊMEA C/PATER

Ø	Box		COD.	€
1/2" x 20	40	10	LPGCP320	7,50
3/4" x 25	20	5	LPGCP425	11,50
1" x 32	15	5	LPGCP532	16,90



JOELHO MACHO 45°

Ø	Box		COD.	€
1" x 32	25	5	LPGC4532	15,20
1 1/4" x 40	10	5	LPGC4540	26,90
1 1/2" x 50	10	5	LPGC4550	42,65

**UNIÃO LONGA**

Ø			COD.	€
32	18	1	LPGRR032	25,70
40	10	1	LPGRR040	36,15
50	5	1	LPGRR050	54,35
63	3	1	LPGRR063	87,10

**BAINHA DE REFORÇO**

Ø			COD.	€
20	250	10	LPGVR020	1,65
25	150	10	LPGVR025	2,35
32	100	10	LPGVR032	4,60
40	50	10	LPGVR040	5,00
50	40	10	LPGVR050	7,55
63	20	1	LPGVR063	22,35

ACESSÓRIOS PARA TUBO POLIETILENO SÉRIE "URBASA" **DVGW**

Accessórios de latão de compressão fabricados em CW617N cumprindo a norma EN 12165.

Certificação DVGW nº DV-7501AR3921 (água PN16 – gás PN10).

Na sua instalação aconselha-se a utilização de Bainha de Reforço evitando-se assim possíveis problemas de estanquidade provenientes das deformações do tubo.



Sistema de compressão por rosca externa.

Temperatura máxima de serviço: 60° C.

Campos de aplicação: Distribuição sobre pressão de fluidos alimentares e não alimentares com temperaturas não superiores a 60° C, bem como água potável e não potável de acordo com as prescrições higiénico-sanitárias.

**UNIÃO DUPLA**

Ø			COD.	€
20	40	10	LPERD020	8,85
25	20	10	LPERD025	11,25
32	15	5	LPERD032	16,10
40	12		LPERD040	25,65
50	8		LPERD050	40,00
63	3		LPERD063	60,45

**UNIÃO MACHO**

Ø			COD.	€
1/2" x 20	60	10	LPERM320	5,30
3/4" x 25	40	10	LPERM425	6,55
1" x 32	30	5	LPERM532	10,55
1 1/4" x 40	20		LPERM640	15,95
1 1/2" x 50	10		LPERM750	23,90
2" x 63	6		LPERM863	35,25

**UNIÃO FÊMEA**

Ø			COD.	€
1/2" x 20	60	10	LPERH320	5,30
3/4" x 25	40	10	LPERH425	7,00
1" x 32	20	5	LPERH532	10,60
1 1/4" x 40	20		LPERH640	17,05
1 1/2" x 50	10		LPERH750	24,80
2" x 63	6		LPERH863	39,30

**JOELHO DUPLO**

Ø			COD.	€
20	40	10	LPECD020	10,40
25	20	10	LPECD025	12,35
32	15		LPECD032	19,80
40	10		LPECD040	32,80
50	5		LPECD050	52,40
63	3		LPECD063	79,00

**JOELHO MACHO**

Ø			COD.	€
1/2" x 20	60	10	LPECM320	7,15
3/4" x 25	30	10	LPECM425	9,45
1" x 32	25		LPECM532	14,75
1 1/4" x 40	10		LPECM640	24,15
1 1/2" x 50	6		LPECM750	38,85
2" x 63	3		LPECM863	58,50

**JOELHO FÊMEA**

Ø			COD.	€
1/2" x 20	60	10	LPECH320	8,65
3/4" x 25	30	10	LPECH425	9,05
1" x 32	25		LPECH532	15,30
1 1/4" x 40	10		LPECH640	24,15
1 1/2" x 50	6		LPECH750	40,45
2" x 63	3		LPECH863	60,35



TÊ

Ø			COD.	€
20	30	10	LPETD020	13,55
25	15	5	LPETD025	16,80
32	10		LPETD032	25,75
40	6		LPETD040	44,60
50	4		LPETD050	72,90
63	2		LPETD063	113,15



TÊ FÊMEA

Ø			COD.	€
1/2" x 20	30	10	LPETH320	10,65
3/4" x 25	20	5	LPETH425	13,65
1" x 32	15		LPETH532	21,55
1 1/4" x 40	6		LPETH640	37,20
1 1/2" x 50	4		LPETH750	58,25
2" x 63	3		LPETH863	91,25



JOELHO FÊMEA C/PATER

Ø			COD.	€
1/2" x 20	30	10	LPECP320	8,75
3/4" x 25	20	5	LPECP425	11,05
1" x 32	15		LPECP532	18,35



ACESSÓRIOS TUBO POLIETILENO SÉRIE "RONCAL"

Acessórios de latão de compressão fabricados em CW617N cumprindo a norma EN 12165.

Na sua instalação aconselha-se a utilização da bainha de reforço, assim evita-se possíveis problemas de estanquidade provenientes das deformações dos tubos.

Sistema de compressão por rosca interna.

Temperatura máxima de serviço: 60º C.

Campos de aplicação: Distribuição sobre pressão de fluidos alimentares e não alimentares com temperaturas não superiores a 60º C, bem como água potável e não potável de acordo com as prescrições higiénico-sanitárias.

Marcação unitária.

Certificação ACS.



UNIÃO DUPLA

Ø			COD.	€
20	40	10	LPORD020	8,05
25	30	10	LPORD025	10,40
32	20	5	LPORD032	15,20
40	15	5	LPORD040	23,75
50	9	3	LPORD050	35,05
63	4	2	LPORD063	62,00



UNIÃO MACHO

Ø			COD.	€
1/2" x 20	70	10	LPORM320	4,80
3/4" x 25	50	10	LPORM425	6,05
1" x 32	30	5	LPORM532	9,20
1 1/4" x 40	20	5	LPORM640	14,20
1 1/2" x 50	10	5	LPORM750	21,25
2" x 63	6	3	LPORM863	37,45



UNIÃO FÊMEA

Ø			COD.	€
1/2" x 20	70	10	LPORH320	5,00
3/4" x 25	50	10	LPORH425	6,50
1" x 32	30	5	LPORH532	9,30
1 1/4" x 40	20	5	LPORH640	14,90
1 1/2" x 50	10	5	LPORH750	21,25
2" x 63	6	3	LPORH863	38,00



JOELHO DUPLO

Ø			COD.	€
20	40	10	LPOCD020	9,25
25	20	10	LPOCD025	11,85
32	15	5	LPOCD032	17,90
40	8	4	LPOCD040	27,75
50	4		LPOCD050	43,00
63	3		LPOCD063	71,70



JOELHO MACHO

Ø			COD.	€
1/2" x 20	50	10	LPOCM320	6,25
3/4" x 25	40	10	LPOCM425	8,40
1" x 32	20	5	LPOCM532	12,70
1 1/4" x 40	12	4	LPOCM640	20,65
1 1/2" x 50	9	3	LPOCM750	29,90
2" x 63	4	2	LPOCM863	47,90



JOELHO FÊMEA

Ø			COD.	€
1/2" x 20	50	10	LPOCH320	5,65
3/4" x 25	40	10	LPOCH425	8,05
1" x 32	20	5	LPOCH532	12,10
1 1/4" x 40	15	5	LPOCH640	19,00
1 1/2" x 50	10	5	LPOCH750	29,25
2" x 63	4		LPOCH863	48,25



TÊ

Ø			COD.	€
20	20	10	LPOTD020	13,35
25	15	5	LPOTD025	16,90
32	15	5	LPOTD032	25,65
40	8	4	LPOTD040	40,10
50	4		LPOTD050	59,95
63	2		LPOTD063	101,00



TÊ FÊMEA

Ø			COD.	€
1/2" x 20	30	10	LPOTH320	10,55
3/4" x 25	20	5	LPOTH425	13,65
1" x 32	15	5	LPOTH532	19,85
1 1/4" x 40	8	4	LPOTH640	32,20
1 1/2" x 50	4		LPOTH750	49,05
2" x 63	3		LPOTH863	73,65



UNIÃO LONGA

Ø			COD.	€
25	24	1	LPORR025	16,35
32	20	1	LPORR032	24,20
40	12	1	LPORR040	34,10
50	7	1	LPORR050	51,35



JOELHO FÊMEA COM PATER

Ø			COD.	€
1/2" x 20	40	10	LPOCP320	8,00
3/4" x 25	20	5	LPOCP425	10,25
1" x 32	15	5	LPOCP532	15,95

ACESSÓRIOS PARA TUBO DE POLIETILENO "GRANDES DIÂMETROS"



UNIÃO DUPLA

Ø		COD.	€
75	4 1	LPGRD075	119,00
90	4 1	LPGRD090	176,00
110	2 1	LPGRD110	261,00



UNIÃO MACHO

Ø		COD.	€
2 1/2" x 75	6 1	LPGRMA75	70,00
3" x 90	5 1	LPGRMB90	102,50
4" x 110	3 1	LPGRM110	164,05



UNIÃO FÊMEA

Ø		COD.	€
2 1/2" x 75	6 1	LPGRHA75	70,50
3" x 90	5 1	LPGRHB90	106,25
4" x 110	3 1	LPGRH110	157,60



JOELHO DUPLO

Ø		COD.	€
75	3 1	LPGCD075	149,00
90	1	LPGCD090	243,00
110	1	LPGCD110	372,00



JOELHO MACHO

Ø		COD.	€
2 1/2" x 75	4 1	LPGCMA75	97,00
3" x 90	2 1	LPGCMB90	161,10
4" x 110	1	LPGCM110	239,10



JOELHO FÊMEA

Ø		COD.	€
2 1/2" x 75	4 1	LPGCHA75	95,50
3" x 90	2 1	LPGCHB90	151,00
4" x 110	1	LPGCH110	232,00



TÊ

Ø		COD.	€
75	2 1	LPGTD075	227,15
90	1	LPGTD090	350,00
110	1	LPGTD110	536,00



TÊ FÊMEA

Ø		COD.	€
2 1/2" x 75	2 1	LPGTHA75	163,35
3" x 90	1	LPGTHB90	253,70
4" x 110	1	LPGTH110	439,65

ACESSÓRIOS DE LATÃO ROSCADOS



2

CURVA 90° F/F

Ø			COD.	€
1/2"	120	10	LS002003	4,00
3/4"	80	10	LS002004	7,00
1"	40	10	LS002005	12,50
1 1/4"	40	5	LS002006	18,50
1 1/2"	25	5	LS002007	26,45
2"	18	1	LS002008	43,00



90

JOELHO 90° F/F

Ø			COD.	€
3/8"	350	10	LS090002	2,05
1/2"	200	10	LS090003	2,40
3/4"	100	10	LS090004	3,70
1"	60	10	LS090005	5,85
1 1/4"	80	5	LS090006	9,20
1 1/2"	55	5	LS090007	12,10
2"	30	5	LS090008	20,10
2 1/2"	16	1	LS09000A	43,85
3"	8	1	LS09000B	66,95
4"	4	1	LS09000D	119,50



90R JOELHO DE REDUÇÃO 90° F/F

Ø			COD.	€
1/2" x 3/8"	250	10	LS090032	1,85
3/4" x 1/2"	150	10	LS090043	3,20
1" x 1/2"	100	10	LS090053	4,20
1" x 3/4"	80	10	LS090054	5,05
1 1/4" x 1"	80	5	LS090065	9,20
1 1/2" x 1"	80	5	LS090075	10,85
1 1/2" x 1 1/4"	60	5	LS090076	13,95



92

JOELHO 90° M/F

Ø			COD.	€
3/8"	350	10	LS092002	1,85
1/2"	200	10	LS092003	2,60
3/4"	100	10	LS092004	3,95
1"	60	10	LS092005	6,45
1 1/4"	35	5	LS092006	9,15
1 1/2"	25	5	LS092007	12,30
2"	25	5	LS092008	22,45
2 1/2"	14	1	LS09200A	45,70
3"	10	1	LS09200B	62,05



130 TÊ 90°

Ø			COD.	€
3/8"	250	10	LS130002	2,20
1/2"	150	10	LS130003	2,70
3/4"	60	10	LS130004	5,50
1"	40	10	LS130005	7,65
1 1/4"	50	5	LS130006	11,40
1 1/2"	40	5	LS130007	14,80
2"	20	5	LS130008	26,05
2 1/2"	11	1	LS13000A	56,25
3"	8	1	LS13000B	89,00
4"	4	1	LS13000D	150,90



130R TÊ 90° REDUÇÃO



Ø			COD.	€
3/4" x 1/2" x 3/4"	80	10	LS130434	4,15
1" x 1/2" x 1"	60	10	LS130535	5,35
1" x 3/4" x 1"	50	10	LS130545	7,15
1 1/4" x 1/2" x 1 1/4"	40	5	LS130636	9,30
1 1/4" x 3/4" x 1 1/4"	35	5	LS130646	10,00
1 1/4" x 1" x 1 1/4"	60	5	LS130656	10,40
1 1/2" x 1/2" x 1 1/2"	60	5	LS130737	10,10
1 1/2" x 3/4" x 1 1/2"	30	5	LS130747	11,05
1 1/2" x 1" x 1 1/2"	25	5	LS130757	12,10
1 1/2" x 1 1/4" x 1 1/2"	40	5	LS130767	13,80
2" x 1/2" x 2"	15	5	LS130838	16,15
2" x 3/4" x 2"	15	5	LS130848	16,15
2" x 1" x 2"	25	5	LS130858	18,30
2" x 1 1/4" x 2"	15	5	LS130868	20,20
2" x 1 1/2" x 2"	10	5	LS130878	22,95



180 CRUZETA

Ø			COD.	€
3/8"	200	10	LS180002	2,65
1/2"	110	10	LS180003	4,20
3/4"	60	10	LS180004	6,15
1"	30	10	LS180005	9,70
1 1/4"	40	5	LS180006	14,75
1 1/2"	30	5	LS180007	19,70
2"	16	1	LS180008	34,55



240 UNIÃO DE REDUÇÃO F/F

Ø			COD.	€
1/2" x 3/8"	350	10	LS240032	1,30
3/4" x 1/2"	200	10	LS240043	2,20
1" x 1/2"	160	10	LS240053	2,85
1" x 3/4"	140	10	LS240054	2,90
1 1/4" x 1"	80	10	LS240065	4,55
1 1/2" x 1"	120	10	LS240075	5,50
1 1/2" x 1 1/4"	100	10	LS240076	6,00
2" x 1"	40	5	LS240085	8,80
2" x 1 1/4"	40	5	LS240086	9,20
2" x 1 1/2"	30	5	LS240087	10,10



245 CASQUILHO DUPLO DE REDUÇÃO M/M

Ø			COD.	€
1/4" x 1/8"	1100	10	LS245010	0,57
3/8" x 1/8"	900	10	LS245020	0,77
3/8" x 1/4"	900	10	LS245021	0,89
1/2" x 1/4"	750	10	LS245031	1,10
1/2" x 3/8"	700	10	LS245032	1,10
3/4" x 1/2"	400	10	LS245043	1,70
1" x 1/2"	280	10	LS245053	2,50
1" x 3/4"	250	10	LS245054	2,55
1 1/4" x 3/4"	110	10	LS245064	3,95
1 1/4" x 1"	100	10	LS245065	4,05
1 1/2" x 3/4"	80	10	LS245074	6,35
1 1/2" x 1"	120	10	LS245075	5,60
1 1/2" x 1 1/4"	100	10	LS245076	5,65
2" x 1"	100	5	LS245085	8,00
2" x 1 1/4"	100	5	LS245086	8,10
2" x 1 1/2"	100	5	LS245087	8,45
2 1/2" x 2"	30	1	LS2450A8	17,15
3" x 2"	20	1	LS2450B8	24,75
3" x 2 1/2"	20	1	LS2450BA	22,95



246 CASQUILHO MARSELHA DE REDUÇÃO M/F

Ø			COD.	€
3/8" M x 1/2" H	400	10	LS246023	1,50
1/2" M x 3/8" H	400	10	LS246032	1,25
1/2" M x 3/4" H	300	10	LS246034	2,15
1/2" M x 1" H	180	10	LS246035	3,35
1/2" M x 1 1/4" H	110	10	LS246036	5,00
3/4" M x 1/2" H	300	10	LS246043	1,90
3/4" M x 1" H	150	10	LS246045	3,35
1" M x 3/4" H	170	10	LS246054	3,35
1" M x 1 1/4" H	110	10	LS246056	4,95
1" M x 1 1/2" H	90	10	LS246057	5,90
1" M x 2" H	50	10	LS246058	9,75
1 1/4" M x 1 1/2" H	80	10	LS246067	7,65
1 1/4" M x 2" H	40	5	LS246068	10,30
1 1/2" M x 2" H	40	5	LS246078	9,65
2" M x 2 1/2" H	40	1	LS24608A	18,25



241 PORCA REDUÇÃO HEXAGONAL

Ø			COD.	€
1/4" M x 1/8" H	1400	10	LS241010	0,31
3/8" M x 1/8" H	1200	10	LS241020	0,58
3/8" M x 1/4" H	1200	10	LS241021	0,52
1/2" M x 1/4" H	500	10	LS241031	1,10
1/2" M x 3/8" H	500	10	LS241032	0,76
3/4" M x 3/8" H	300	10	LS241042	1,55
3/4" M x 1/2" H	300	10	LS241043	1,30
1" M x 1/2" H	250	10	LS241053	2,55
1" M x 3/4" H	250	10	LS241054	2,15
1 1/4" M x 1/2" H	150	10	LS241063	5,60
1 1/4" M x 3/4" H	150	10	LS241064	4,05
1 1/4" M x 1" H	150	10	LS241065	3,05
1 1/2" M x 1/2" H	140	10	LS241073	5,60
1 1/2" M x 3/4" H	140	10	LS241074	6,75
1 1/2" M x 1" H	140	10	LS241075	5,10
1 1/2" M x 1 1/4" H	140	10	LS241076	3,40
2" M x 1/2" H	60	5	LS241083	9,50
2" M x 3/4" H	60	5	LS241084	9,50
2" M x 1" H	60	5	LS241085	10,25
2" M x 1 1/4" H	60	5	LS241086	9,25
2" M x 1" 1/2H	60	5	LS241087	8,00
2 1/2" M x 1 1/4" H	40	1	LS2410A6	15,80
2 1/2" M x 1 1/2" H	40	1	LS2410A7	17,20
2 1/2" M x 2" H	40	1	LS2410A8	14,10
3" M x 2" H	20	1	LS2410B8	28,75
3" M x 2 1/2" H	20	1	LS2410BA	19,10
4" M x 2" H	20	1	LS2410D8	47,95
4" M x 2 1/2" H	20	1	LS2410DA	49,85
4" M x 3" H	20	1	LS2410DB	46,05



270 UNIÃO F/F

Ø			COD.	€
3/8"	350	10	LS270002	1,30
1/2"	250	10	LS270003	1,75
3/4"	150	10	LS270004	2,70
1"	100	10	LS270005	4,20
1 1/4"	50	10	LS270006	5,80
1 1/2"	70	10	LS270007	8,35
2"	40	5	LS270008	15,45
2 1/2"	30	1	LS27000A	24,00
3"	22	1	LS27000B	31,15
4"	10	1	LS27000D	62,85



280 CASQUILHO DUPLO M/M

Ø			COD.	€
1/8"	1200	10	LS280000	0,34
1/4"	1000	10	LS280001	0,57
3/8"	800	10	LS280002	0,96
1/2"	350	10	LS280003	1,35
3/4"	200	10	LS280004	1,85
1"	150	10	LS280005	2,95
1 1/4"	80	10	LS280006	4,50
1 1/2"	60	10	LS280007	6,05
2"	30	5	LS280008	9,35
2 1/2"	20	1	LS28000A	21,05
3"	25	1	LS28000B	32,45
4"	12	1	LS28000D	70,50



290 TAMPÃO MACHO COM REBORDO

Ø	📦		COD.	€
1/8"	1500	10	LS290000	0,48
1/4"	1300	10	LS290001	0,58
3/8"	1000	10	LS290002	0,69
1/2"	600	10	LS290003	0,93
3/4"	350	10	LS290004	1,45
1"	200	10	LS290005	2,25
1 1/4"	130	10	LS290006	3,50
1 1/2"	100	10	LS290007	5,05
2"	60	5	LS290008	8,45
2 1/2"	40	1	LS29000A	18,10
3"	24	1	LS29000B	24,40
4"	12	1	LS29000D	40,20



300 TAMPÃO FÊMEA

Ø	📦		COD.	€
1/4"	1200	10	LS300001	0,48
3/8"	1000	10	LS300002	0,74
1/2"	450	10	LS300003	1,00
3/4"	300	10	LS300004	1,55
1"	200	10	LS300005	2,35
1 1/4"	150	10	LS300006	2,90
1 1/2"	120	10	LS300007	4,35
2"	70	5	LS300008	6,75



315 CANHÃO PARA MANGUEIRA

Ø	📦		COD.	€
3/8" x 12 mm.	400	10	LS315002	1,30
1/2" x 14 mm.	250	10	LS315003	2,10
1/2" x 20 mm.	190	10	LS315203	2,65
3/4" x 20 mm.	150	10	LS315004	2,90
3/4" x 25 mm.	120	10	LS315254	3,85
1" x 20 mm.	100	10	LS315205	4,50
1" x 25 mm.	90	10	LS315255	4,80
1" x 30 mm.	80	10	LS315005	5,15
1 1/4" x 35 mm.	50	5	LS315006	9,65
1 1/4" x 40 mm.	40	5	LS315406	11,70
1 1/2" x 45 mm.	20	5	LS315007	12,20
2" x 50 mm.	40	5	LS315508	19,40
2" x 60 mm.	30	5	LS315008	21,60



318 TÊ 5 VIAS

Ø	📦		COD.	€
1"x1"x1"x 92 mm.	60	5	LS318005	11,40
1"x1"x1"x 110 mm.	50	5	LS318L05	13,30



CASQUILHO DUPLA ROSCA

Ø	📦		COD.	€
1" M x 3/4" H	500	10	LS317A05	1,45
7/8" M x 3/4" H	1.000	10	LS317A78	0,59



529 CASQUILHO MARSELHA M/F

Ø	📦		COD.	€
3/8"	650	10	LS529002	0,83
1/2"	300	10	LS529003	1,30
3/4"	250	10	LS529004	2,15
1"	120	10	LS529005	3,45
1 1/4"	80	10	LS529006	5,15
1 1/2"	60	10	LS529007	7,15
2"	60	5	LS529008	11,10



LIGAÇÃO PARA CONTADOR M/F

Ø	📦		COD.	€
1/2" M x 3/4" H	180	2	LS317034	3,65
1/2" M x 7/8" H	140	2	LS31703S	4,15
3/4" M x 1" H	110	2	LS317045	5,60
1" M x 1 1/4" H	50	2	LS317056	10,50



529H CASQUILHO MARSELHA HEXAGONAL M/F

Ø	📦		COD.	€
1/2"	300	10	LS529H03	1,85



529L CASQUILHO MARSELHA M/F LONGO

Ø	📦		COD.	€
1/2"	270	10	LS529L03	2,00



330 JUNÇÃO FÊMEA S/D

Ø			COD.	€
1/2"	100	10	LS330003	6,00
3/4"	70	10	LS330004	9,25
1"	50	10	LS330005	11,95
1 1/4"	30	5	LS330006	18,60
1 1/2"	20	5	LS330007	23,00
2"	20	5	LS330008	43,45



331 JUNÇÃO M/F S/D

Ø			COD.	€
1/2"	100	10	LS331003	6,20
3/4"	60	10	LS331004	9,80
1"	40	10	LS331005	14,00
1 1/4"	25	5	LS331006	21,45
1 1/2"	20	5	LS331007	27,00
2"	20	5	LS331008	46,00



340 JUNÇÃO CÓNICA F/F S/C

Ø			COD.	€
1/2"	100	10	LS340003	6,00
3/4"	70	10	LS340004	9,00
1"	50	10	LS340005	11,55
1 1/4"	30	5	LS340006	18,20
1 1/2"	20	5	LS340007	23,70
2"	20	5	LS340008	37,45
2 1/2"	14	1	LS34000A	80,50
3"	12	1	LS34000B	106,35



341 JUNÇÃO CÓNICA M/F S/C

Ø			COD.	€
1/2"	100	10	LS341003	6,05
3/4"	60	10	LS341004	8,90
1"	40	10	LS341005	13,35
1 1/4"	25	5	LS341006	19,35
1 1/2"	20	5	LS341007	26,20
2"	20	5	LS341008	38,80
2 1/2"	10	1	LS34100A	97,80
3"	6	1	LS34100B	136,55



JUNÇÃO MANGUEIRA / MANGUEIRA

Ø			COD.	€
20 x 20	120	20	LSHH2020	5,00
25 x 25	80	20	LSHH2525	8,10
30 x 30	40	10	LSHH3030	12,30
35 x 35	20	10	LSHH3535	19,10
40 x 40	20	5	LSHH4040	32,35
45 x 45	25	5	LSHH4545	34,50
50 x 50	20	5	LSHH5050	33,05
60 x 60	15	5	LSHH6060	56,75
70 x 70	12	1	LSHH7070	81,90



PASSAMUROS

Ø			COD.	€
3/8"	180	10	LSTC0002	2,55
1/2"	120	10	LSTC0003	3,50
3/4"	80	10	LSTC0004	4,80
1"	50	10	LSTC0005	7,20
1 1/4"	30	10	LSTC0006	10,05
1 1/2"	25	5	LSTC0007	15,15
2"	25	5	LSTC0008	23,75
2 1/2"	24	1	LSTC000A	34,55
3"	12	1	LSTC000B	61,35



JUNÇÃO ROSCA / ROSCA

Ø			COD.	€
1/2" x 1/2"	200	20	LSTT0303	3,90
3/4" x 3/4"	120	20	LSTT0404	6,70
1" x 1"	80	10	LSTT0505	9,15
1 1/4" x 1 1/4"	40	10	LSTT0606	16,90
1 1/2" x 1 1/2"	50	5	LSTT0707	28,65
2" x 2"	25	5	LSTT0808	47,35
2 1/2" x 2 1/2"	20	1	LSTT0A0A	56,05



JUNÇÃO MANGUEIRA / ROSCA MACHO

Ø			COD.	€
1/2" x 20	160	20	LSHT2003	4,70
3/4" x 25	100	20	LSHT2504	7,55
1" x 30	50	10	LSHT3005	10,95
1 1/4" x 35	30	10	LSHT3506	17,70
1 1/4" x 40	30	5	LSHT4006	30,70
1 1/2" x 45	35	5	LSHT4507	31,25
2" x 60	20	5	LSHT6008	51,20
2 1/2" x 70	16	1	LSHT700A	69,05



AUMENTO EM LATÃO M/F

Ø		COD.	€
3/8" M x 3/8" H x 30 mm.	360 10	LSB00302	2,10
3/8" M x 3/8" H x 50 mm.	250 5	LSB00502	2,90
3/8" M x 3/8" H x 100 mm.	180	LSB01002	5,25
1/2" M x 1/2" H x 10 mm.	450 10	LSB00103	1,30
1/2" M x 1/2" H x 20 mm.	380 10	LSB00203	2,05
1/2" M x 1/2" H x 30 mm.	240 10	LSB00303	2,65
1/2" M x 1/2" H x 40 mm.	200 10	LSB00403	3,40
1/2" M x 1/2" H x 50 mm.	160 5	LSB00503	4,05
1/2" M x 1/2" H x 60 mm.	140 5	LSB00603	4,80
1/2" M x 1/2" H x 70 mm.	130 5	LSB00703	5,55
1/2" M x 1/2" H x 80 mm.	140	LSB00803	6,20
1/2" M x 1/2" H x 100 mm.	105	LSB01003	7,65
3/4" M x 3/4" H x 20 mm.	210 10	LSB00204	2,65
3/4" M x 3/4" H x 40 mm.	130 10	LSB00404	4,35
3/4" M x 3/4" H x 50 mm.	100 5	LSB00504	5,15
3/4" M x 3/4" H x 60 mm.	90 5	LSB00604	6,20
3/4" M x 3/4" H x 80 mm.	96 1	LSB00804	8,00
3/4" M x 3/4" H x 100 mm.	78 1	LSB01004	9,85



AUMENTO CROMADO M/F

Ø		COD.	€
3/8" M x 3/8" H x 30 mm.	360 10	LSBC0302	2,05
3/8" M x 3/8" H x 50 mm.	250 5	LSBC0502	3,05
3/8" M x 3/8" H x 100 mm.	180	LSBC1002	5,10
1/2" M x 1/2" H x 20 mm.	380 10	LSBC0203	2,15
1/2" M x 1/2" H x 40 mm.	200 10	LSBC0403	3,75
1/2" M x 1/2" H x 50 mm.	160 5	LSBC0503	4,40
1/2" M x 1/2" H x 60 mm.	140 5	LSBC0603	5,15
1/2" M x 1/2" H x 80 mm.	140 1	LSBC0803	6,90
1/2" M x 1/2" H x 100 mm.	105 1	LSBC1003	8,35
3/4" M x 3/4" H x 40 mm.	130 10	LSBC0404	4,80
3/4" M x 3/4" H x 50 mm.	100 5	LSBC0504	6,20
3/4" M x 3/4" H x 80 mm.	96 1	LSBC0804	8,55
3/4" M x 3/4" H x 100 mm.	78 1	LSBC1004	10,60



BOBINE

Ø		COD.	€
1/2" x 50 mm.	240 5	LSN00503	2,40
1/2" x 60 mm.	160 5	LSN00603	3,35
1/2" x 70 mm.	160 5	LSN00703	3,65
1/2" x 80 mm.	140 2	LSN00803	4,25
1/2" x 90 mm.	140 2	LSN00903	4,75
1/2" x 100 mm.	100 2	LSN01003	5,30
1/2" x 150 mm.	100 2	LSN01503	8,55
1/2" x 200 mm.	70 2	LSN02003	11,65
1/2" x 250 mm.	70 2	LSN02503	14,75
3/4" x 50 mm.	140 5	LSN00504	3,10
3/4" x 60 mm.	120 5	LSN00604	3,90
3/4" x 70 mm.	100 5	LSN00704	5,25
3/4" x 80 mm.	90 3	LSN00804	5,50
3/4" x 90 mm.	90 3	LSN00904	6,90
3/4" x 100 mm.	90 2	LSN01004	7,05
3/4" x 150 mm.	70 2	LSN01504	10,90
3/4" x 200 mm.	50 2	LSN02004	15,70
3/4" x 250 mm.	40 2	LSN02504	19,75
1" x 50 mm.	90 5	LSN00505	4,30
1" x 60 mm.	80 5	LSN00605	6,05
1" x 70 mm.	60 5	LSN00705	6,60
1" x 80 mm.	90 3	LSN00805	8,45
1" x 90 mm.	70 2	LSN00905	10,20
1" x 100 mm.	60 2	LSN01005	11,05
1" x 125 mm.	50 2	LSN01255	13,65
1" x 150 mm.	44 2	LSN01505	16,50
1" x 200 mm.	30 2	LSN02005	23,20
1" x 250 mm.	30 2	LSN02505	30,40
1 1/4" x 50 mm.	45 5	LSN00506	6,05
1 1/4" x 60 mm.	45 5	LSN00606	7,45
1 1/4" x 70 mm.	40 5	LSN00706	8,90
1 1/4" x 80 mm.	40 2	LSN00806	10,35
1 1/4" x 90 mm.	36 3	LSN00906	12,10
1 1/4" x 100 mm.	30 2	LSN01006	13,75
1 1/4" x 125 mm.	26 2	LSN01256	17,45
1 1/4" x 150 mm.	20 2	LSN01506	21,10
1 1/4" x 200 mm.	26 2	LSN02006	29,70
1 1/4" x 250 mm.	26 2	LSN02506	42,55
1 1/2" x 100 mm.	76 2	LSN01007	16,85
1 1/2" x 150 mm.	50 2	LSN01507	26,80
1 1/2" x 200 mm.	34 2	LSN02007	36,85



BOBINE CROMADA

Ø		COD.	€
1/2" x 50 mm.	240 1	LSNC0503	3,65
1/2" x 60 mm.	160 1	LSNC0603	4,55
1/2" x 70 mm.	130 1	LSNC0703	5,30
1/2" x 100 mm.	100 1	LSNC1003	8,25
1/2" x 150 mm.	100 1	LSNC1503	12,60
3/4" x 50 mm.	140 1	LSNC0504	4,70
3/4" x 60 mm.	120 1	LSNC0604	4,80
3/4" x 70 mm.	100 1	LSNC0704	6,90
3/4" x 100 mm.	90 1	LSNC1004	10,30
3/4" x 150 mm.	60 1	LSNC1504	16,00
1" x 50 mm.	90 1	LSNC0505	6,35
1" x 100 mm.	45 1	LSNC1005	15,40
1" x 150 mm.	30 1	LSNC1505	24,00



BOBINE DE AUMENTO

Ø		COD.	€
1/2" x 100 mm.	100 2	LSP01003	5,70
1/2" x 150 mm.	100 2	LSP01503	9,20
1/2" x 200 mm.	70 2	LSP02003	12,75
3/4" x 100 mm.	90 2	LSP01004	7,60
3/4" x 150 mm.	70 2	LSP01504	11,70
3/4" x 200 mm.	50 2	LSP02004	17,00
1" x 100 mm.	60 2	LSP01005	12,00
1" x 150 mm.	44 2	LSP01505	18,00
1" x 200 mm.	30 2	LSP02005	25,30
1" x 250 mm.	30 2	LSP02505	33,20

ACESSÓRIOS ROSCADOS - CROMADOS

90 JOELHO 90° F/F

Ø		COD.	€
3/8"	350 1	LS090P02	2,15
1/2"	200 1	LS090P03	2,70
3/4"	100 1	LS090P04	4,40
1"	60 1	LS090P05	6,70

92 JOELHO 90° M/F

Ø		COD.	€
3/8"	350 1	LS092P02	2,20
1/2"	200 1	LS092P03	3,05
3/4"	100 1	LS092P04	4,60
1"	60 1	LS092P05	7,50

130 TÊ 90°

Ø		COD.	€
3/8"	250 1	LS130P02	2,50
1/2"	150 1	LS130P03	3,30
3/4"	60 1	LS130P04	6,15
1"	40 1	LS130P05	8,75

241 PORCA REDUÇÃO HEXAGONAL

Ø		COD.	€
1/2" M x 3/8" H	500 1	LS241P32	0,95
3/4" M x 1/2" H	300 1	LS241P43	1,50

245 CASQUILHO DUPLO DE REDUÇÃO M/M

Ø		COD.	€
1/2" x 3/8"	450 1	LS245P32	1,40
3/4" x 1/2"	400 1	LS245P43	2,15

270 UNIÃO F/F

Ø		COD.	€
3/8"	350 1	LS270P02	1,65
1/2"	250 1	LS270P03	2,20
3/4"	150 1	LS270P04	3,05
1"	100 1	LS270P05	4,85

280 CASQUILHO DUPLO M/M

Ø		COD.	€
3/8"	400 1	LS280P02	1,20
1/2"	350 1	LS280P03	1,60
3/4"	200 1	LS280P04	2,25
1"	150 1	LS280P05	3,60

290 TAMPÃO MACHO COM REBORDO

Ø		COD.	€
3/8"	500 1	LS290P02	0,95
1/2"	400 1	LS290P03	1,15
3/4"	350 1	LS290P04	1,75
1"	200 1	LS290P05	2,70

300 TAMPÃO FÊMEA

Ø		COD.	€
3/8"	500 1	LS300P02	1,05
1/2"	450 1	LS300P03	1,20
3/4"	300 1	LS300P04	1,80
1"	200 1	LS300P05	2,70

529 CASQUILHO MARSELHA M/F

Ø		COD.	€
3/8"	400 1	LS529P02	1,15
1/2"	300 1	LS529P03	1,70
3/4"	250 1	LS529P04	2,65
1"	120 1	LS529P05	4,20

ACESSÓRIOS ROSCADOS - NIQUELADOS



90 JOELHO 90° F/F

Ø		COD.	€
3/8"	350 10	LS090C02	2,15
1/2"	200 10	LS090C03	2,60
3/4"	100 10	LS090C04	4,15
1"	60 10	LS090C05	6,25



92 JOELHO 90° M/F

Ø		COD.	€
3/4"	100 10	LS092C04	4,35
1"	60 10	LS092C05	7,05



130 TÊ 90°

Ø		COD.	€
3/4"	60 10	LS130C04	5,65
1"	40 10	LS130C05	8,20



241 PORCA REDUÇÃO HEXAGONAL

Ø		COD.	€
1/2" M x 3/8" H	500 10	LS241C32	0,89
3/4" M x 1/2" H	300 10	LS241C43	1,40



245 CASQUILHO DUPLO DE REDUÇÃO M/M

Ø		COD.	€
3/4" x 1/2"	400 10	LS245C43	2,05



270 UNIÃO F/F

Ø		COD.	€
3/8"	350 10	LS270C02	1,60
1/2"	250 10	LS270C03	2,10
3/4"	150 10	LS270C04	2,80
1"	100 10	LS270C05	4,55



280 CASQUILHO DUPLO M/M

Ø		COD.	€
3/4"	200 10	LS280C04	2,15
1"	150 10	LS280C05	3,35



290 TAMPÃO MACHO COM REBORDO

Ø		COD.	€
3/8"	1000 10	LS290C02	0,89
1/2"	600 10	LS290C03	1,10
3/4"	350 10	LS290C04	1,60
1"	200 10	LS290C05	2,55



300 TAMPÃO FÊMEA

Ø		COD.	€
1"	200 10	LS300C05	2,40



529 CASQUILHO MARSELHA M/F

Ø		COD.	€
3/4"	250 10	LS529C04	2,55
1"	120 10	LS529C05	3,90



529H CASQUILHO MARSELHA HEXAGONAL M/F CHAVE 12MM

Ø		COD.	€
1/2"	300 10	LS529HC3	1,70

ATÉ FIM DE EXISTÊNCIAS

ACESSÓRIOS DE LATÃO SOLDAR / ROSCAR

90 JOELHO 90° FÊMEA

Ø			COD.	€
1/2" x 12	420	20	LSR90123	1,70
1/2" x 15	400	20	LSR90153	1,80
1/2" x 18	270	15	LSR90183	2,20
1/2" x 22	210	15	LSR90223	2,65
3/4" x 18	200	10	LSR90184	2,80
3/4" x 22	150	10	LSR90224	3,20
3/4" x 28	100	10	LSR90284	4,35
1" x 28	80	10	LSR90285	5,50

92 JOELHO 90° MACHO

Ø			COD.	€
1/2" x 12	340	20	LSR92123	1,55
1/2" x 15	320	20	LSR92153	1,65
1/2" x 18	270	15	LSR92183	2,20
1/2" x 22	210	10	LSR92223	2,60
3/4" x 22	160	10	LSR92224	3,10

243 CASQUILHO MACHO

Ø			COD.	€
1/2" x 12	600	20	LSR43123	1,00
1/2" x 15	600	20	LSR43153	1,00
1/2" x 18	450	15	LSR43183	1,45
3/4" x 15	375	15	LSR43154	1,75
3/4" x 18	300	10	LSR43184	1,70
3/4" x 22	300	10	LSR43224	1,60
3/4" x 28	220	10	LSR43284	2,25
1" x 22	200	10	LSR43225	2,55
1" x 28	180	10	LSR43285	2,40
1 1/2" x 42	60	5	LSR43427	6,65

270 CASQUILHO FÊMEA

Ø			COD.	€
1/2" x 12	560	20	LSR27123	1,10
1/2" x 15	540	20	LSR27153	1,15
1/2" x 18	420	15	LSR27183	1,45
1/2" x 22	300	15	LSR27223	1,60
3/4" x 15	330	15	LSR27154	1,70
3/4" x 18	300	10	LSR27184	1,85
3/4" x 22	230	10	LSR27224	2,20
3/4" x 28	170	10	LSR27284	2,35
1" x 22	170	10	LSR27225	3,10
1" x 28	130	10	LSR27285	3,40
1 1/4" x 35	70	5	LSR27356	5,35
1 1/2" x 42	45	5	LSR27427	8,00

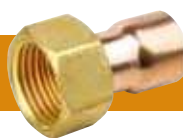
359 TERMINAL ABOCARDADO

Ø			COD.	€
1/2" x 12	420	20	LSR59123	1,45
1/2" x 15	380	20	LSR59153	2,15
1/2" x 18	330	15	LSR59183	2,25
1/2" x 22	255	15	LSR59223	2,50
3/4" x 15	255	15	LSR59154	2,70
3/4" x 18	230	10	LSR59184	3,10
3/4" x 22	180	10	LSR59224	3,50
1" x 18	160	10	LSR59185	4,50
1" x 22	130	10	LSR59225	4,70
1" x 28	110	10	LSR59285	5,10

130 TÊ 90° FÊMEA

Ø			COD.	€
1/2" x 15	260	20	LSR13153	1,85
1/2" x 18	210	15	LSR13183	2,55
1/2" x 22	120	15	LSR13223	3,35
3/4" x 28	70	10	LSR13284	5,45

JOELHO FÊMEA C/PATER

Ø			COD.	€
1/2" x 15	240	20	LSRCP153	2,35
1/2" x 22	135	15	LSRCP223	3,35
3/4" x 18	140	10	LSRCP184	3,75
3/4" x 22	120	10	LSRCP224	4,15

ACESSÓRIOS DE REPARAÇÃO

Tapaporos e derivação em latão.

Abraçadeiras de união para tubos de cobre.

Tubos conforme DIN 1786.

Elastômetro em EPDM.



TAPAPOROS



TOMADAS DERIVAÇÃO

Ø			COD.	€
10	160	10	VS700010	6,65
12	140	10	VS700012	7,45
14	100	10	VS700014	9,55
15	100	10	VS700015	10,60
16	90	10	VS700016	11,55
18	90	10	VS700018	12,60
20	80	10	VS700020	13,70
22	60	10	VS700022	13,80
25	50	5	VS700025	16,05
28	40	5	VS700028	18,65
32	35	5	VS700032	21,40
35	30	5	VS700035	22,85
42	20	5	VS700042	32,60
54	10	5	VS700054	52,70
63	7	1	VS700063	71,40

Ø			COD.	€
1/2" x 10 mm.	120	10	VS701010	10,35
1/2" x 12 mm.	100	10	VS701012	11,35
1/2" x 14 mm.	90	10	VS701014	14,25
1/2" x 15 mm.	90	10	VS701015	14,90
1/2" x 16 mm.	80	10	VS701016	14,90
1/2" x 18 mm.	80	10	VS701018	15,35
1/2" x 20 mm.	70	10	VS701020	16,80
1/2" x 22 mm.	60	10	VS701022	16,80
3/4" x 25 mm.	40	5	VS701025	21,40
3/4" x 28 mm.	30	5	VS701028	23,75
3/4" x 32 mm.	25	5	VS701032	26,15
3/4" x 35 mm.	25	5	VS701035	29,80
1" x 42 mm.	15	5	VS701042	41,30
1 1/4" x 54 mm.	10	5	VS701054	68,10

ACESSÓRIOS DE LATÃO BICONE PARA TUBO DE COBRE

Certificação KIWA.

Certificação GASTEC.

Pressão máxima de trabalho: PN 16 a 30° C.

Temperatura máxima de trabalho: 120° C.

Aplicações: Distribuição de água quente e fria, instalações de aquecimento, gás (instalações domésticas) e fuel líquido.

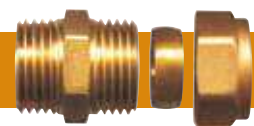

CASQUILHO MACHO

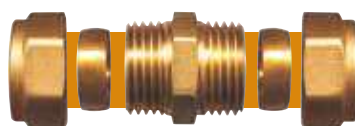

UNIÃO DUPLA

Ø			COD.	€
3/8" x 12	200	10	TAP00022	2,45
3/8" x 15	180	10	TAP00052	3,10
1/2" x 12	150	10	TAP00023	3,35
1/2" x 15	100	10	TAP10053	3,50
1/2" x 16	100	10	TAP10063	4,90
1/2" x 18	100	10	TAP10073	5,20
1/2" x 22	70	10	TAP00093	6,90
3/4" x 15	80	10	TAP10054	5,25
3/4" x 18	70	10	TAP10074	5,60
3/4" x 22	50	10	TAP10094	5,45
1" x 22	50	10	TAP10095	6,90
1" x 28	30	5	TAP100B5	8,45

Ø			COD.	€
12 x 12	150	10	TAP00122	3,35
15 x 12	100	10	TAP00152	3,75
15 x 15	100	10	TAP10155	4,45
16 x 16	100	10	TAP10166	6,30
18 x 18	100	10	TAP10177	7,05
22 x 15	60	10	TAP00195	6,55
22 x 22	50	10	TAP00199	6,70
28 x 28	30	5	TAP001BB	10,60

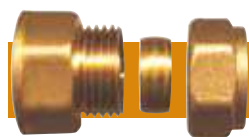

CASQUILHO FÊMEA

Ø		COD.	€
3/8" x 10	200 10	TAP00212	2,85
3/8" x 12	150 10	TAP00222	2,95
3/8" x 15	120 10	TAP00252	4,80
1/2" x 12	150 10	TAP00223	4,70
1/2" x 15	100 10	TAP10253	3,55
1/2" x 16	100 10	TAP10263	5,95
1/2" x 18	100 10	TAP10273	5,60
1/2" x 22	60 10	TAP00293	7,85
3/4" x 15	80 10	TAP00254	6,30
3/4" x 18	60 10	TAP10274	7,65
3/4" x 22	50 10	TAP00294	6,05
1" x 22	50 10	TAP10295	9,40
1" x 28	30 5	TAP002B5	10,80



JOELHO DUPLO 90°

Ø		COD.	€
12 x 12	100 10	TAP00322	4,35
15 x 15	100 10	TAP10355	4,60
16 x 16	70 10	TAP10366	6,60
18 x 18	60 10	TAP10377	7,30
22 x 22	40 10	TAP00399	7,85
28 x 28	20 5	TAP003BB	12,75

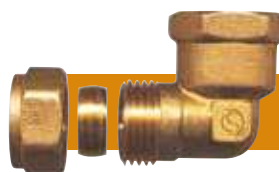

JOELHO FÊMEA 90°

Ø		COD.	€
3/8" x 12	100 10	TAP00522	4,10
1/2" x 12	100 10	TAP00523	4,65
1/2" x 15	80 10	TAP00553	4,55
1/2" x 16	60 10	TAP10563	7,15
1/2" x 18	70 10	TAP10573	6,85
3/4" x 15	50 10	TAP00554	6,90
3/4" x 22	50 10	TAP00594	7,75
1" x 28	30 5	TAP005B5	13,95

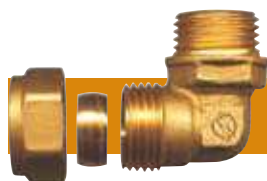

JOELHO MACHO 90°

Ø		COD.	€
3/8" x 12	150 10	TAP00422	3,85
1/2" x 12	120 10	TAP00423	5,30
1/2" x 15	100 10	TAP10453	5,05
1/2" x 18	60 10	TAP10473	5,65
3/4" x 22	40 10	TAP10494	7,75
1" x 28	30 5	TAP104B5	13,85



JOELHO FÊMEA C/PATER

Ø		COD.	€
1/2" x 15	40 10	TAP00653	7,85



TÊ 90°

Ø		COD.	€
12 x 12 x 12	100 10	TAP07222	5,10
15 x 15 x 15	60 10	TAP17555	6,20
16 x 16 x 16	40 10	TAP17666	9,40
18 x 18 x 18	50 10	TAP17777	9,50
22 x 15 x 22	30 10	TAP07959	8,65
22 x 22 x 22	20 10	TAP07999	9,90
28 x 28 x 28	15 5	TAP07BBB	16,30

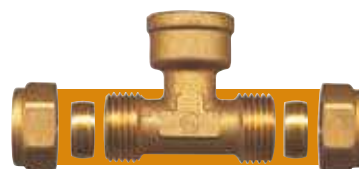

TÊ FÊMEA 90°

Ø		COD.	€
1/2" x 15 x 15	50 10	TAP19535	7,15
1/2" x 22 x 22	30 10	TAP09939	8,45
3/4" x 22 x 22	30 10	TAP19949	11,80

ACESSÓRIOS PARA PEX

Pressão máxima de trabalho: PN16 a 60° C.

Pressão máxima de serviço: 95° C.

Aplicações: Distribuição sobre pressão de fluidos não alimentares com temperatura igual ou inferior a 80° C (ex. instalações de aquecimento), fluidos alimentares e de uso sanitário (ex. instalações higiênico-sanitárias).



UNIÃO DUPLA

Ø		COD.	€
12 x 12 x 2.0	100 10	TR8RD012	6,85
15 x 15 x 2.5	100 10	TR8RD015	6,65
16 x 16 x 2.0	100 10	TR9RD016	6,70
16 x 16 x 2.2	100 10	TR8RD016	6,35
18 x 18 x 2.5	80 10	TR8RD018	8,55
20 x 20 x 2.0	60 10	TR9RD020	10,90
20 x 20 x 2.8	60 10	TR8RD020	10,60
22 x 22 x 3.0	50 5	TR8RD022	12,00
25 x 25 x 2.3	40 5	TR9RD025	15,45
25 x 25 x 3.5	40 10	TR8RD025	15,60
32 x 32 x 3.0	25 1	TR9RD032	24,15



CASQUILHO FÊMEA

Ø		COD.	€
3/8" x 12 x 2.0	150 10	TR8RH122	3,65
1/2" x 12 x 2.0	150 10	TR9RH123	4,05
1/2" x 15 x 2.5	150 10	TR8RH153	3,65
1/2" x 16 x 2.0	150 10	TR9RH163	3,85
1/2" x 16 x 2.2	150 10	TR8RH163	3,85
1/2" x 18 x 2.5	100 10	TR8RH183	5,25
1/2" x 20 x 2.0	80 10	TR9RH203	6,05
1/2" x 20 x 2.8	80 10	TR8RH203	6,10
1/2" x 22 x 3.0	60 10	TR8RH223	7,55
3/4" x 16 x 2.0	100 10	TR9RH164	4,60
3/4" x 16 x 2.2	100 10	TR8RH164	4,60
3/4" x 18 x 2.5	80 10	TR8RH184	5,40
3/4" x 20 x 2.0	80 10	TR9RH204	6,30
3/4" x 20 x 2.8	80 10	TR8RH204	6,05
3/4" x 22 x 3.0	70 10	TR8RH224	7,95
3/4" x 25 x 2.3	50 10	TR9RH254	11,20
3/4" x 25 x 3.5	50 5	TR8RH254	10,75
3/4" x 32 x 3.0	40 5	TR9RH324	13,95
1" x 25 x 2.3	40 5	TR9RH255(1)	11,95
1" x 25 x 3.5	40 5	TR8RH255	13,15
1" x 32 x 3.0	40 1	TR9RH325	15,85



CASQUILHO MACHO

Ø		COD.	€
3/8" x 12 x 2.0	170 10	TR8RM122	3,65
1/2" x 12 x 2.0	170 10	TR8RM123	3,55
1/2" x 15 x 2.5	160 10	TR8RM153	3,55
1/2" x 16 x 2.0	160 10	TR9RM163	3,55
1/2" x 16 x 2.2	160 10	TR8RM163	3,55
1/2" x 18 x 2.5	100 10	TR8RM183	4,80
1/2" x 20 x 2.0	100 10	TR9RM203	5,80
1/2" x 20 x 2.8	100 10	TR8RM203	5,85
1/2" x 22 x 3.0	60 10	TR8RM223	7,75
3/4" x 16 x 2.0	120 10	TR9RM164	4,25
3/4" x 16 x 2.2	120 10	TR8RM164	4,25
3/4" x 18 x 2.5	100 10	TR8RM184	5,20
3/4" x 20 x 2.0	80 10	TR9RM204	5,70
3/4" x 20 x 2.8	80 10	TR8RM204	5,65
3/4" x 22 x 3.0	60 10	TR8RM224	7,00
3/4" x 25 x 2.3	50 10	TR9RM254	10,55
3/4" x 25 x 3.5	50 10	TR8RM254	11,00
3/4" x 32 x 3.0	40 5	TR9RM324	14,50
1" x 25 x 2.3	40 5	TR9RM255	12,70
1" x 25 x 3.5	40 10	TR8RM255	12,55
1" x 32 x 3.0	40 1	TR9RM325	15,30



JOELHO DUPLO 90°

Ø		COD.	€
12 x 12 x 2.0	80 10	TR9CD012	7,60
15 x 15 x 2.5	80 10	TR8CD015	7,20
16 x 16 x 2.0	80 10	TR9CD016	7,15
16 x 16 x 2.2	80 10	TR8CD016	7,40
18 x 18 x 2.5	60 10	TR8CD018	10,75
20 x 20 x 2.0	50 10	TR9CD020	12,00
20 x 20 x 2.8	50 10	TR8CD020	12,20
22 x 22 x 3.0	40 10	TR8CD022	14,50
25 x 25 x 2.3	20 5	TR9CD025	20,05
25 x 25 x 3.5	20 5	TR8CD025 (1)	20,75
32 x 32 x 3.0	20 1	TR9CD032	30,00



JOELHO PARA CAIXA 100°

Ø		COD.	€
1/2" x 16 x 2.0	70 10	TR9A0163	5,95
1/2" x 16 x 2.2	70 10	TR8A0163	5,95



JOELHO PARA CAIXA 105°

Ø		COD.	€
1/2" x 16 x 2.0	70 10	TR9A5163	6,55

(1) Até fim de existências

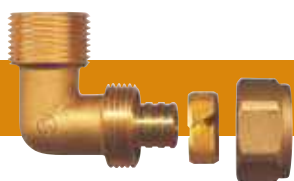

JOELHO MACHO 90°

Ø		COD.	€
1/2" x 15 x 2.5	100 10	TR8CM153	6,10
1/2" x 16 x 2.0	100 10	TR9CM163	5,65
1/2" x 16 x 2.2	100 10	TR8CM163	5,65
1/2" x 18 x 2.5	80 10	TR8CM183	7,05
1/2" x 20 x 2.0	60 10	TR9CM203	9,45
1/2" x 20 x 2.8	60 10	TR8CM203(1)	9,05
3/4" x 16 x 2.0	70 10	TR9CM164	6,60
3/4" x 16 x 2.2	70 10	TR8CM164	6,60
3/4" x 18 x 2.5	70 10	TR8CM184	7,95
3/4" x 20 x 2.0	50 10	TR9CM204	9,30
3/4" x 20 x 2.8	50 10	TR8CM204	9,30
3/4" x 22 x 3.0	50 10	TR8CM224	11,50
3/4" x 25 x 2.3	30 5	TR9CM254	15,95
3/4" x 25 x 3.5	30 5	TR8CM254	15,30
3/4" x 32 x 3.0	20 5	TR9CM324	19,00
1" x 25 x 2.3	30 5	TR9CM255	18,40
1" x 25 x 3.5	30 5	TR8CM255	18,30
1" x 32 x 3.0	20 1	TR9CM325	21,90

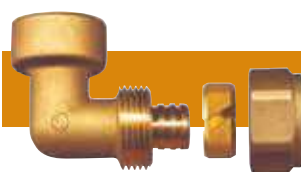

JOELHO FÊMEA 90°

Ø		COD.	€
3/8" x 15 x 2.5	80 10	TR8CH152(1)	5,30
1/2" x 12 x 2.0	80 10	TR8CH123	6,10
1/2" x 15 x 2.5	80 10	TR8CH153	6,10
1/2" x 16 x 2.0	80 10	TR9CH163	6,10
1/2" x 16 x 2.2	80 10	TR8CH163	6,10
1/2" x 18 x 2.5	70 10	TR8CH183	8,35
1/2" x 20 x 2.0	60 10	TR9CH203	8,75
1/2" x 20 x 2.8	60 10	TR8CH203	8,55
1/2" x 22 x 3.0	40 10	TR8CH223	10,00
3/4" x 16 x 2.0	40 10	TR9CH164	6,85
3/4" x 16 x 2.2	40 10	TR8CH164	6,85
3/4" x 18 x 2.5	40 10	TR8CH184	7,95
3/4" x 20 x 2.0	40 10	TR9CH204	9,45
3/4" x 20 x 2.8	40 10	TR8CH204	9,45
3/4" x 22 x 3.0	40 10	TR8CH224	11,55
3/4" x 25 x 2.3	30 5	TR9CH254	16,30
3/4" x 25 x 3.5	30 5	TR8CH254	15,45
3/4" x 32 x 3.0	20 5	TR9CH324(1)	23,85
1" x 25 x 2.3	30 5	TR9CH255	18,40
1" x 25 x 3.5	30 5	TR8CH255	18,40
1" x 32 x 3.0	20 1	TR9CH325	22,75

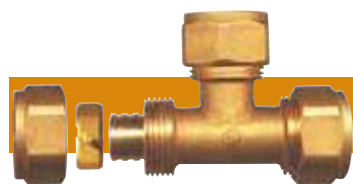

TÊ 90°

Ø		COD.	€
12 x 12 x 12 x 2.0	60 10	TR9TD012(1)	10,10
15 x 15 x 15 x 2.5	60 10	TR8TD015	10,35
16 x 16 x 16 x 2.0	60 10	TR9TD016	10,05
16 x 16 x 16 x 2.2	60 10	TR8TD016	10,05
18 x 18 x 18 x 2.5	40 10	TR8TD018	15,20
20 x 20 x 20 x 2.0	30 10	TR9TD020	16,05
22 x 22 x 22 x 3.0	20 5	TR8TD022	20,65
25 x 25 x 25 x 2.3	20 5	TR9TD025	27,55
32 x 32 x 32 x 3.0	10 1	TR9TD032(1)	41,05



JOELHO FÊMEA C/ PATER

Ø		COD.	€
1/2" x 15 x 2.5	50 10	TR8CP153 (1)	6,60
1/2" x 16 x 2.0	50 10	TR9CP163	6,95
1/2" x 16 x 2.2	50 10	TR8CP163	6,95
1/2" x 18 x 2.5	50 10	TR8CP183	8,90
1/2" x 20 x 2.0	40 10	TR9CP203	9,90
1/2" x 20 x 2.8	40 10	TR8CP203	9,90



TÊ MACHO

Ø		COD.	€
1/2" x 16 x 2.0	60 10	TR9TM163	8,40
1/2" x 20 x 2.0	30 10	TR9TM203	13,40
1/2" x 20 x 2.8	30 10	TR8TM203	13,40
1/2" x 22 x 3.0	30 10	TR8TM223	16,05
3/4" x 16 x 2.2	40 10	TR8TM164	11,15
3/4" x 20 x 2.0	30 10	TR9TM204	15,20
3/4" x 20 x 2.8	30 10	TR8TM204	15,20
3/4" x 25 x 2.3	20 10	TR9TM254	23,60
3/4" x 25 x 3.5	20 5	TR8TM254	22,75
3/4" x 32 x 3.0	20 5	TR9TM324	50,10
1" x 32 x 3.0	10 1	TR9TM325	33,70



TÊ FÊMEA 90°

Ø		COD.	€
1/2" x 15 x 2.5	50 10	TR8TH153	8,90
1/2" x 16 x 2.0	50 10	TR9TH163	8,90
1/2" x 16 x 2.2	50 10	TR8TH163	8,90
1/2" x 18 x 2.5	40 10	TR8TH183	12,55
1/2" x 20 x 2.0	30 10	TR9TH203	13,60
1/2" x 22 x 3.0	30 10	TR8TH223	16,60
3/4" x 16 x 2.0	30 10	TR9TH164	10,75
3/4" x 16 x 2.2	30 10	TR8TH164	10,75
3/4" x 20 x 2.0	30 10	TR9TH204	14,10
3/4" x 20 x 2.8	30 10	TR8TH204	14,10
3/4" x 22 x 3.0	30 5	TR8TH224	16,25
3/4" x 25 x 2.3	20 5	TR9TH254	24,15
3/4" x 25 x 3.5	20 5	TR8TH254(1)	23,15
3/4" x 32 x 3.0	15 5	TR9TH324	49,45
1" x 25 x 2.3	20 5	TR9TH255	24,55
1" x 25 x 3.5	20 5	TR8TH255	24,55
1" x 32 x 3.0	15 1	TR9TH325	34,25

(1) Até fim de existências



**CAIXA PLÁSTICA
PARA JOELHO 100° E 105°**

Ø		COD.	€
Única	400 1	TR9PL100	2,95

ACESSÓRIOS PARA MULTICAMADA DE COMPRESSÃO

Pressão máxima de trabalho: PN16 a 60°C.

Temperatura máxima de trabalho: 95° C.

Acessórios para tubo PEX-AL-PEX.

Aplicações: distribuição de fluidos não alimentares com temperatura inferior a 95° C

(ex. instalações de aquecimento) e de fluidos alimentares e de uso sanitário (ex. instalações higiênico-sanitárias).



UNIÃO DUPLA

Ø		COD.	€
16 x 16	100 10	TM011616	8,70
18 x 18	80 10	TM011818	13,05
20 x 20	60 10	TM012020	12,50
26 x 26	40 5	TM012626	21,25
32 x 32	25 5	TM013232	41,40



CASQUILHO FÊMEA

Ø		COD.	€
1/2" x 16	150 10	TM021603	5,85
1/2" x 18	100 10	TM021803	7,05
1/2" x 20	80 10	TM022003	7,00
3/4" x 16	100 10	TM021604	7,55
3/4" x 18	80 10	TM021804	7,65
3/4" x 20	80 10	TM022004	7,95
3/4" x 26	50 5	TM022604	14,70
1" x 26	40 5	TM022605	15,25
1" x 32	40 5	TM023205	24,60



CASQUILHO MACHO

Ø		COD.	€
1/2" x 16	160 10	TM001603	5,15
1/2" x 18	100 10	TM001803	6,85
1/2" x 20	100 10	TM002003	6,85
3/4" x 16	120 10	TM001604	7,15
3/4" x 18	100 10	TM001804	7,15
3/4" x 20	80 10	TM002004	7,15
3/4" x 26	50 5	TM002604	12,80
1" x 26	40 5	TM002605	12,80
1" x 32	40 1	TM003205	24,35



JOELHO DUPLO 90°

Ø		COD.	€
16 x 16	80 10	TM031616	10,70
18 x 18	50 10	TM031818	13,60
20 x 20	50 10	TM032020	13,60
26 x 26	20 5	TM032626	22,90
32 x 32	20 1	TM033232	43,30

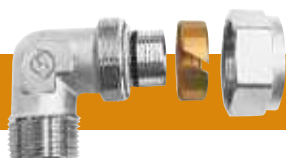

JOELHO MACHO 90°

Ø		COD.	€
1/2" x 16	100 10	TM041603	7,30
1/2" x 18	80 10	TM041803	10,00
1/2" x 20	60 10	TM042003	10,40
3/4" x 16	70 10	TM041604	9,45
3/4" x 18	70 10	TM041804	9,90
3/4" x 20	50 10	TM042004	10,40
3/4" x 26	30 5	TM042604	18,40
1" x 26	30 5	TM042605	18,55
1" x 32	30 1	TM043205	30,35

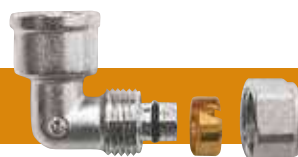

JOELHO FÊMEA 90°

Ø		COD.	€
1/2" x 16	80 10	TM051603	7,75
1/2" x 18	70 10	TM051803	9,75
1/2" x 20	60 10	TM052003	9,90
3/4" x 16	40 10	TM051604	10,35
3/4" x 18	40 10	TM051804	9,90
3/4" x 20	40 10	TM052004	10,40
3/4" x 26	30 5	TM052604	19,40
1" x 26	30 5	TM052605	21,65
1" x 32	20 1	TM053205	31,35



JOELHO FÊMEA C/PATER

Ø		COD.	€
1/2" x 16	50 10	TM061603	11,60
1/2" x 18	50 10	TM061803	12,00



TÊ 90°

Ø		COD.	€
16 x 16 x 16	60 10	TM070666	15,05
18 x 18 x 18	30 10	TM070777	19,95
20 x 20 x 20	30 10	TM070888	20,10
26 x 26 x 26	20 5	TM072666	32,95
32 x 32 x 32	10 1	TM070CCC	56,60



TÊ 90°

Ø		COD.	€
1/2" x 16	60 10	TM080636	11,40
1/2" x 18	40 10	TM080737	14,60
1/2" x 20	30 10	TM080838	14,60
3/4" x 16	40 10	TM080646	15,85
3/4" x 18	40 10	TM080747	16,30
3/4" x 20	30 10	TM080848	16,40
3/4" x 26	20 5	TM082646	28,40
1" x 26	15 5	TM082656	29,65
1" x 32	10 1	TM080C5C	48,70



TÊ FÊMEA 90°

Ø		COD.	€
1/2" x 16	50 10	TM090636	11,90
1/2" x 18	40 10	TM090737	15,20
1/2" x 20	30 10	TM090838	15,15
3/4" x 16	30 10	TM090646	16,05
3/4" x 18	30 10	TM090747	16,55
3/4" x 20	30 10	TM090848	17,55
3/4" x 26	20 5	TM092646	29,65
1" x 26	20 5	TM092656	29,05
1" x 32	10 1	TM090C5C	48,20



TAMPÃO PARA TUBO MULTICAMADA

Ø		COD.	€
16 x 2,0	300 10	TMTP1603	3,10



ACESSÓRIOS
POLIETILENO

ACESSÓRIOS DE
POLIETILENO

Os acessórios electro soldáveis ATUSA são utilizados para a instalação de tubagens de polietileno para a condução de gás até 10 bares e de água potável e outros fluídos até 16 bares de pressão nominal.

As principais utilizações são a condução de água e gás, sistemas de rega, instalações industriais e ramais de abastecimento de água.

DADOS TÉCNICOS

Material:

A matéria prima está de acordo com as exigências da EN 1555 e EN 12201.

Todos os acessórios E.S. bem como os canhões em PE são fabricados em PE 100-RC.

Especificação técnica da matéria prima:

Parâmetros	Descrição	Unidade	Método de teste
Densidade	≥930	kg/m ³	ISO 1183
Índice de fluidez	de 0,2 a 1,4	g/10 min	ISO 1133
Tempo de indução à oxidação	≥20	min	ISO 11357-1
Cor	Preto		

CARACTERÍSTICAS GEOMÉTRICAS

As medidas dimensionais estão de acordo com a EN ISO 3126.

Todas as dimensões dos acessórios cumprem com os requisitos da EN 1555 e EN 12201.

Resistência a pressão interna:

Gás:

Pressão máxima operativa (MOP)

10 bar – SDR 11

10 bar – SDR 17

Água:

PN 16 para SDR 11

PN 10 para SDR 17

Eletrosoldadura:

A electrosoldadura pode realizar-se:

- 1) Automático (com leitor do código de barras)
- 2) Manual (introduzindo os dados da etiqueta)
- 3) Os acessórios electrosoldáveis podem ser utilizados em tubos PE 100, PE 100-RC e PE 80.

Marcação:

Dados	Descrição
Descrição	EN 12201 PN: EN 1555
Diâmetro nominal do tubo	P. ex. 110
Material	P. ex. PE 100-RC
SDR do acessório	SDR 11
SDR gama de fusão	SDR 11 - SDR 17
Data de fabricação	P. ex. 01/2021
Aplicações	gás/água

Os acessórios electrosoldáveis comercializados pela ATUSA contam com as seguintes características que os distinguem de outros fornecedores:



1. A seta indica o mês de fabrico e os dois dígitos em ambos os lados indicam o ano.
2. Conectores de latão com diâmetro standard de 4.0 mm, com a possibilidade de adaptadores para 4.7 mm.
3. Placa de características: Com o diâmetro do acessório, material, SDR, uso (gás e água).
4. Comprovativo de soldadura: Permitem perceber visualmente se o processo de soldadura decorreu correctamente.
5. Espiral de soldadura: Revestido com PE para a protecção contra possíveis danos durante a instalação.
6. Etiqueta: Contêm informação do tamanho e diâmetro do acessório (igual a alínea 3); Números identificativos, um número único que o diferencia e torna possível saber toda a traçabilidade do acessório, pressão máxima de trabalho, tempo de soldadura e de arrefecimento, voltagem (sempre 39,5V); SDR; código de barras, dados para as máquinas equipadas com leitor de código de barras; normas com que os acessórios cumprem.

INSTRUÇÕES DE MONTAGEM



1. Medir o diâmetro do tubo.



2. Escolher o acessório adequado.



3. Cortar o tubo de forma totalmente reta.



4. Medir a zona a raspar.



5. Raspar a zona de soldadura do tubo.



6. Limpar a zona com líquido apropriado.



7. Marcar a profundidade de inserção do tubo.

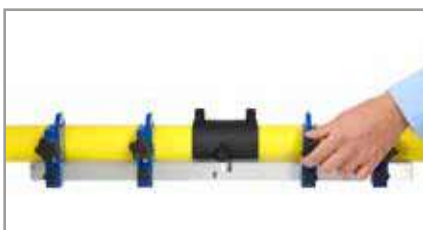

8. Utilizar um posicionador para fixar o tubo.



9. Ler o código de barras.



10. Seguir as instruções indicadas na máquina.



11. Início da soldadura.



12. Verificar se os testemunhos de soldadura estão visíveis.

IMPORTANTE: Utilizar uma máquina bem calibrada e aplicar produtos para limpeza recomendados.



UNIÃO

Ø			COD.	€
20	200	1	E2700020	4,15
25	200	1	E2700025	4,15
32	180	1	E2700032	4,40
40	120	1	E2700040	5,30
50	90	1	E2700050	6,45
63	50	1	E2700063	5,65
75	30	1	E2700075	10,85
90	20	1	E2700090	10,80
110	14	1	E2700110	14,10
125	20	1	E2700125	21,10
140	14	1	E2700140	28,75
160	12	1	E2700160	26,80
180	6	1	E2700180	52,95
200	6	1	E2710200	46,50
200	4	1	E2700200	52,20
225	4	1	E2710225	68,80
225	2	1	E2700225	79,60
250	2	1	E2710250	100,10
250	2	1	E2700250	109,00
280	2	1	E2710280	176,50
280	1	1	E2700280	204,65
315	2	1	E2710315	153,50
315	1	1	E2700315	173,75
355	2	1	E2710355	248,35
400	1	1	E2710400	286,45
450	1	1	E2710450	413,20

SDR 11

SDR 17



UNIÃO DE REDUÇÃO

Ø			COD.	€
25/20	180	1	ER002520	7,90
32/20	180	1	ER003220	8,10
32/25	180	1	ER003225	8,50
40/25	120	1	ER004025	12,10
40/32	120	1	ER004032	10,05
50/25	100	1	ER005025	13,55
50/32	100	1	ER005032	11,70
50/40	90	1	ER005040	11,85
63/25	50	1	ER006325	13,40
63/32	50	1	ER006332	13,40
63/40	50	1	ER006340	13,40
63/50	50	1	ER006350	13,40
75/63	30	1	ER007563	20,45
90/63	20	1	ER009063	21,90
90/75	20	1	ER009075	25,30
110/63	12	1	ER011063	37,50
110/75	12	1	ER011075	31,60
110/90	12	1	ER011090	31,60
125/90	20	1	ER012590	57,45
125/110	20	1	ER125110	59,95
160/90	12	1	ER016090	68,05
160/110	12	1	ER160110	77,85
160/125	1	1	ER160125*	90,80
200/160	4	1	ER200160	137,15

* Redução soldar topo a topo + uniões EF.



JOELHO 90°

Ø			COD.	€
20	150	1	E0900020	10,85
25	150	1	E0900025	10,85
32	120	1	E0900032	10,85
40	60	1	E0900040	12,35
50	40	1	E0900050	15,95
63	25	1	E0900063	16,05
75	15	1	E0900075	23,35
90	12	1	E0900090	29,05
110	8	1	E0900110	38,75
125	1	1	E0900125	73,40
140	1	1	E0900140	125,40
160	1	1	E0900160	125,40



JOELHO 45°

Ø			COD.	€
20	150	1	E1200020	10,85
25	150	1	E1200025	10,85
32	120	1	E1200032	10,85
40	60	1	E1200040	12,85
50	40	1	E1200050	15,95
63	25	1	E1200063	16,05
75	15	1	E1200075	27,85
90	12	1	E1200090	29,05
110	8	1	E1200110	38,75
125	1	1	E1200125	73,40
140	1	1	E1200140	125,40
160	1	1	E1200160	125,40



Ø			COD.	€
200	1	1	E0900200	288,25
250	1	1	E0900250	688,95
315	1	1	E0900315	1.131,15



Ø			COD.	€
200	1		E1200200	319,20
250	1		E1200250	723,65
315	1		E1200315	1.207,75

PARA AS RESTANTES MEDIDAS POR FAVOR CONSULTAR



TÊ SIMPLES

Ø		COD.	€
20/20	150 1	ET002020	12,10
25/25	140 1	ET002525	12,10
32/32	100 1	ET003232	12,65
40/40	60 1	ET004040	14,70
50/50	30 1	ET005050	18,95
63/63	20 1	ET006363	19,70
75/75	12 1	ET007575	27,75
90/90	12 1	ET009090	41,55
110/110	6 1	ET110110	52,00
125/125	6 1	ET125125	85,85
160/160	1 1	ET160160	135,85



Ø		COD.	€
200/200	1	ET200200	473,40
250/250	1	ET250250	903,95
315/315	1	ET315315	1.594,80



TÊ DE REDUÇÃO

Ø		COD.	€
25/20	140 1	ET002520	12,10
32/20	100 1	ET003220	12,65
32/25	100 1	ET003225	12,65
40/25	60 1	ET004025	14,70
40/32	60 1	ET004032	14,70
50/25	30 1	ET005025	18,95
50/32	30 1	ET005032	18,95
50/40	30 1	ET005040	18,95
63/32	20 1	ET006332	19,70
63/40	20 1	ET006340	19,70
63/50	20 1	ET006350	19,70
75/63	7 1	ET007563	27,75
90/63	7 1	ET009063	41,55
90/75	8 1	ET009075	51,20
110/63	7 1	ET011063	52,00
110/75	10 1	ET011075	52,00
110/90	10 1	ET011090	52,00
160/90	4 1	ET016090	170,15
160/110	4 1	ET160110	170,15



SELA DE DERIVAÇÃO

Ø		COD.	€
63/32	30 1	E7016332	32,30
63/40	30 1	E7016340	32,35
63/50	20 1	E7016350	32,35
75/32	25 1	E7017532	32,85
75/63	20 1	E7017563	35,40
90/32	20 1	E7019032	33,65
90/63	15 1	E7019063	37,40
110/32	12 1	E7011132	34,55
110/63	10 1	E7011163	37,85
125/32	12 1	E7011232	37,85
125/63	10 1	E7011263	42,10
160/32	8 1	E7011632	50,05
160/63	8 1	E7011663	54,95



Ø		COD.	€
200/32	20 1	E7012032	71,65
200/63	20 1	E7012063	71,65
250/25	10 1	E7012525	81,75
250/32	10 1	E7012532	81,75
250/40	10 1	E7012540	81,75
250/50	10 1	E7012550	90,50
250/63	10 1	E7012563	90,50
315/25	10 1	E7013125	94,75
315/32	10 1	E7013132	94,75
315/40	10 1	E7013140	94,75
315/50	10 1	E7013150	115,95
315/63	10 1	E7013163	115,95



TAMPÃO

Ø		COD.	€
20	200 1	E3000020	8,55
25	200 1	E3000025	8,75
32	150 1	E3000032	9,75
40	120 1	E3000040	10,30
50	80 1	E3000050	12,85
63	50 1	E3000063	16,45
75	30 1	E3000075	25,70
90	20 1	E3000090	30,35
110	14 1	E3000110	40,30
125	20 1	E3000125	57,05
140	14 1	E3000140	60,90
160	12 1	E3000160	74,80
200	4 1	E3000200*	166,40
225	1 1	E3000225*	205,75
250	1 1	E3000250*	310,10
280	1 1	E3000280*	497,25
315	1 1	E3000315*	554,55

* Tampão de soldar topo a topo + união electro soldável.

PARA AS RESTANTES MEDIDAS POR FAVOR CONSULTAR



CELA DE REPARAÇÃO

Ø		COD.	€
63	45 1	E7000063	47,10
90	30 1	E7000090	50,10
110	20 1	E7000110	63,80
125	20 1	E7000125	69,45
160	15 1	E7000160	83,55
180	15 1	E7000180	90,30



TOMADA EM CARGA

Ø		COD.	€
40/32	20 1	ETC04032	51,80
50/32	20 1	ETC05032	37,95
63/32	20 1	ETC06332	38,45
63/40	15 1	ETC06340	52,65
63/50	12 1	ETC06350	55,45
75/32	20 1	ETC07532	44,95
90/32	20 1	ETC09032	42,30
90/40	20 1	ETC09040	55,45
90/50	15 1	ETC09050	55,45
90/63	15 1	ETC09063	55,45
110/32	10 1	ETC11032	45,10
110/40	10 1	ETC11040	66,60
110/50	10 1	ETC11050	58,00
110/63	10 1	ETC11063	58,00
125/32	8 1	ETC12532	47,15
125/50	8 1	ETC12550	61,60
125/63	8 1	ETC12563	61,60



Ø		COD.	€
140/32	6 1	ETC14032	49,45
140/63	6 1	ETC14063	65,95
160/32	6 1	ETC16032	52,15
160/50	6 1	ETC16050	68,25
160/63	6 1	ETC16063	68,25
200/32	4 1	ETC20032	61,95
200/40	4 1	ETC20040	61,95
200/63	4 1	ETC20063	83,20



ADAPTADOR PE LATÃO MACHO

Ø		COD.	€
20 x 1/2"	220 1	ERM00203	22,05
25 x 3/4"	200 1	ERM00254	23,00
32 x 1"	140 1	ERM00325	26,25
40 x 1 1/4"	100 1	ERM00406	39,95
50 x 1 1/2"	70 1	ERM00507	45,60
63 x 2"	40 1	ERM00638	53,35
75 x 2 1/2"	5 1	ERM0075A	110,55
90 x 3"	18 1	ERM0090B	139,30
110 x 4"	8 1	ERM0110D	233,00
125 x 4"	6 1	ERM0125D	271,20



ADAPTADOR PE LATÃO FÊMEA

Ø		COD.	€
20 x 1/2"	60 1	ERH00203	19,70
25 x 3/4"	60 1	ERH00254	20,25
32 x 1"	200 1	ERH00325	28,30
40 x 1 1/4"	100 1	ERH00406	39,80
50 x 1 1/2"	84 1	ERH00507	55,10
63 x 2"	50 1	ERH00638	75,20
75 x 2 1/2"	5 1	ERH0075A	125,95
90 x 3"	20 1	ERH0090B	179,10
110 x 4"	8 1	ERH0110D	227,55
125 x 4"	6 1	ERH0125D	257,60

PARA AS RESTANTES MEDIDAS POR FAVOR CONSULTAR



TRANSIÇÃO PE / METAL

Ø		COD.	€
25/20	1	ETM02520	17,05
32/25	1	ETM03225	25,25
40/32	1	ETM04032	30,90
50/40	1	ETM05040	43,10
63/50	1	ETM06350	58,20
75/65	1	ETM07565	71,65



TRANSIÇÃO INJETADA PE / METAL

Ø		COD.	€
25/20	1	ETA25020	17,05
32/25	1	ETA32025	25,20
63/50	1	ETA63050	58,30



VÁLVULA EM PE

Ø		COD.	€
25	1	EVAL0025	122,00
32	1	EVAL0032	122,00
40	1	EVAL0040	122,00
50	1	EVAL0050	228,00
63	1	EVAL0063	233,05
75	1	EVAL0075	289,05
90	1	EVAL0090	309,90
110	1	EVAL0110	412,90
125	1	EVAL0125	509,00
160	1	EVAL0160	1.137,90



HASTE DE MANOBRA PARA VÁLVULA PE

COD.	€
ELLV6011	79,10

Para abertura e fecho da nossa válvula PE.
Regulação 600 a 1100 mm.

ACESSÓRIOS PARA SOLDAR TOPO A TOPO



Os acessórios de soldadura topo a topo comercializados pela ATUSA têm as seguintes características:

Acessório conforme UNE-EN 1555-3 e UNE-EN 12201-3

Fabricados em SDR 11 e SDR 17

Cor preta

Dimensões conforme a UNE-EN ISO 3126

Utilizados na união de tubagem de polietileno na condução de água, gás, sistemas de rega e instalação industriais.

A soldadura pode ser realizada de forma automática ou manual.

Os acessórios para soldar topo a topo podem ser soldados a tubos PE 100, PE 100-RC e PE 80, de SDR 9 e SDR 17.

INSTRUÇÕES DE MONTAGEM



1 – Posicionar a máquina de soldadura topo a topo adequadamente, caso seja necessário, por motivo de chuva, frio ou vento, aconselha-se a utilização de uma tenda.

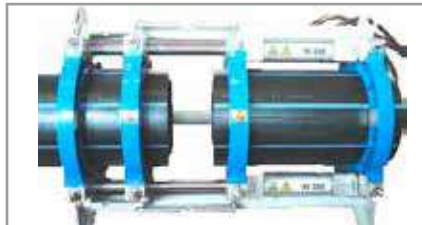

2 – Posicionar e alinhar nos mordentes os tubos e ou o acessório de PE.



3 – Raspar o material até que este esteja totalmente preparado na sua superfície transversal.



4 – Eliminar as sobras sem tocar na superfície raspada.



5 – Comprovar o alinhamento, controlando o paralelismo entre os extremos do material a soldar (tolerância máxima 0,5mm) controlando o desalinhamento (tolerância máxima 10% da espessura do tubo)



6 – Limpar as faces da placa de aquecimento de soldar com isopropanol (álcool) a frio, verificar com um termómetro de contato que a temperatura da placa está entre os 210-225°C. Verificar a pressão de arrasto e anotar na ficha da soldadura. Calcular P1, a pressão para a formação do cordão inicial (pressão de soldadura tabelada + pressão de arrasto) e anotar na ficha de soldadura.



7 – Colocar a placa entre os tubos e dar pressão na máquina com a pressão calculada P1, até formar um cordão inicial uniforme e da altura correta, reduzir a pressão a P2= a 10% p1 para o aquecimento.



8 – Passado o tempo de aquecimento t2 (tablado em cada máquina), separar os tubos da placa. Retirar a placa e unir rapidamente os tubos num tempo máximo recomendado na t3.



9 – Aumentar progressivamente a pressão desde 0 a pressão requerida p1 durante um tempo t4 e manter durante um tempo t5. Deixar arrefecer a soldadura sem retirar pressão p1 nem desapertar os mordentes. Passado o tempo de arrefecimento desapertar os mordentes e retirar os tubos da máquina.

Nota: O instalador deve ter em atenção os parâmetros de soldadura constantes no manual técnico da máquina.



PORTA FLANGE

DN		COD.	€
25	1	EPB11025	4,55
32	1	EPB11032	5,70
40	1	EPB11040	6,50
50	1	EPB11050	7,75
63	1	EPB17063	5,65
63	1	EPB11063	7,75
75	1	EPB17075	8,85
75	1	EPB11075	10,05
90	1	EPB17090	11,70
90	1	EPB11090	12,60
110	1	EPB17110	13,20
110	1	EPB11110	14,40
125	1	EPB17125	19,35
125	1	EPB11125	20,00
140	1	EPB11140	31,25
160	1	EPB17160	26,30
160	1	EPB11160	30,10
180	1	EPB17180	40,15
180	1	EPB11180	66,15
200	1	EPB17200	43,25
200	1	EPB11200	53,55
225	1	EPB17225	48,65
250	1	EPB17250	62,40
250	1	EPB11250	83,70
280	1	EPB17280	111,70
315	1	EPB17315	121,70
315	1	EPB11315	136,50



JOELHO 90°

DN		COD.	€
32	1	W0900032	4,35
40	1	W0900040	5,65
50	1	W0900050	7,10
63	1	W1790063	9,40
63	1	W0900063	10,20
75	1	W1790075	13,65
75	1	W0900075	14,05
90	1	W1790090	16,65
90	1	W0900090	20,15
110	1	W1790110	27,45
110	1	W0900110	29,55
125	1	W1790125	48,00
125	1	W0900125	54,70
140	1	W0900140	73,10
160	1	W1790160	61,30
160	1	W0900160	73,10
180	1	W1790180	74,05
180	1	W0900180	84,20
200	1	W1790200	96,05
200	1	W0900200	116,75
225	1	W1790225	113,25
225	1	W0900225	130,95
250	1	W1790250	255,60
250	1	W0900250	284,20
280	1	W1790280	332,00
280	1	W0900280	369,10
315	1	W1790315	375,00
315	1	W0900315	405,15

SDR 11

SDR 17



JOELHO A 45°

DN		COD.	€
32	1	W1200032	7,00
40	1	W1200040	8,75
50	1	W1200050	9,90
63	1	W1712063	12,50
63	1	W1200063	13,95
75	1	W1712075	16,55
75	1	W1200075	16,55
90	1	W1712090	17,10
90	1	W1200090	20,60
110	1	W1712110	22,20
110	1	W1200110	29,55
125	1	W1712125	43,50
125	1	W1200125	48,35
160	1	W1712160	61,30
160	1	W1200160	77,15
180	1	W1712180	74,30
180	1	W1200180	83,90
200	1	W1712200	89,70
200	1	W1200200	103,35
225	1	W1712225	122,40
225	1	W1200225	136,05
250	1	W1712250	236,95
250	1	W1200250	277,05
280	1	W1712280	332,00
280	1	W1200280	369,10
315	1	W1712315	375,00
315	1	W1200315	405,15

SDR 11

SDR 17



TÊ

DN		COD.	€
90/90	1	WT170090	21,90
90/90	1	WT090090	22,85
110/110	1	WT170110	25,05
110/110	1	WT110110	31,60
125/125	1	WT170125	44,25
125/125	1	WT125125	51,80
160/160	1	WT170160	101,50
160/160	1	WT160160	107,35
200/200	1	WT170200	150,00
225/225	1	WT170225	242,50
250/250	1	WT170250	305,75
315/315	1	WT170315	599,80

SDR 11

SDR 17

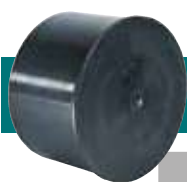

TAMPÃO

Ø		COD.	€
63	1	W3000063	4,40
75	1	W3000075	7,80
90	1	W3000090	9,70
110	1	W3000110	16,50
125	1	W3000125	20,00
140	1	W3000140	33,00
160	1	W3000160	36,30



UNIÃO DE REDUÇÃO

Ø		COD.	€
75/63	1	WR075063	10,95
90/63	1	WR090063	16,40
90/75	1	WR090075	16,40
110/63	1	WR011063	19,15
110/75	1	WR011075	19,15
110/90	1	WR011090	19,15
125/90	1	WR012590	33,35
125/110	1	WR125110	33,35
140/110	1	WR140110	48,30
140/125	1	WR140125	48,30
160/90	1	WR016090	35,50
160/110	1	WR160110	35,50
160/125	1	WR160125	57,40
160/140	1	WR160140	64,60
200/160	1	WR200160	91,30
250/160	1	WR250160	198,45
250/200	1	WR250200	167,80

MÁQUINAS DE ELETROSOLDADURA

DE 20 - 160 mm.



COD.
EMQ20160

DE 20 - 315 mm.



COD.
EMQ20315

DE 20 - 500 mm.



COD.
EMQ20500

CARACTERÍSTICAS	EMQ20160	EMQ20315	EMQ20500
Válido para tubos de	20 - 160 mm.	20 - 315 mm.	20 - 500 mm.
Voltagem	8 ± 48V.	8 ± 48V.	8 ± 48V.
Embalagem	Bolsa	Caixa de alumínio	Caixa de alumínio
Leitor de código de barras	Lápis ótico	Lápis ótico	Lápis ótico
Impressora	Sob pedido	Sob pedido	Sob pedido
Tensão de rede	230 V 50/60 Hz.	230 V 50/60 Hz.	230 V 50/60 Hz.
Potência máxima absorvida	2.000 W.	4.000 W.	6.400 W.
Intensidade (Amperes)	80 A.	100 A.	120 A.
Ligações externas	USB, R232	USB, R232	USB, R232
Memória (Soldaduras)	350	500	4.000
Tipo de Proteção	IP 54	IP 54	IP 54
Comprimento de cabo	3 metros	3 metros	3 metros
Dimensões	200x250x210 mm.	240x220x240 mm.	520x435x230 mm.
Peso	7 Kg.	15 Kg.	18 Kg.
P.V.P. €	2.522,00	3.984,00	5.743,00

MÁQUINAS DE SOLDADURA TOPO A TOPO
DE 40 - 160 mm.

COD.
BASIC 160
DE 75 - 250 mm.

COD.
BASIC 250
DE 90 - 315 mm.

COD.
BASIC 315

CARACTERÍSTICAS	BASIC 160	BASIC 250	BASIC 315
Material	HDPE, PP, PP-R, PVDF Para outros produtos consultar	HDPE, PP, PP-R, PVDF Para outros produtos consultar	HDPE, PP, PP-R, PVDF Para outros produtos consultar
Alimentação	230 V Monofásica 50/60 Hz	230 V Monofásica 50/60 Hz	230 V Monofásica 50/60 Hz
Potência total absorvida	3000 W	4200 W	5050 W
Temperatura de trabalho	180° C - 280° C	180° C - 280° C	180° C - 280° C
Temperatura ambiente de serviço	-10° C - 40° C	-10° C - 40° C	-10° C - 40° C
Tempo em que se alcança a temperatura de uso	<20	<20	<20
Memória	4.000 ciclos	4.000 ciclos	4.000 ciclos
Ajustes personalizados	50 personalizações	50 personalizações	50 personalizações
Wi-Fi ready	App "SET & GO PRO"	App "SET & GO PRO"	App "SET & GO PRO"
Dimensões do chassi (A x L x H)	606 x 365 x 375 mm.	850 x 470 x 400 mm.	981 x 586 x 520 mm.
Dimensões do grupo Eletro-hidráulico (A x L x H)	585 x 384 x 463 mm.	585 x 384 x 463 mm.	585 x 384 x 463 mm.
Peso do chassi	32 kg.	63 kg.	86 kg.
Peso total	88 kg.	132 kg.	174 kg.
P.V.P. €	consultar	consultar	consultar

ACESSÓRIOS

RASPADOR AUTOMÁTICO



DIMENSÕES	COD.	€
75 - 180 mm.	ERAAU075	1.605,00
140 - 400 mm.	ERAAU140	2.712,00

POSICIONADOR



DIMENSÕES	COD.	€
20 - 63 mm.	EALI2063	860,00
63 - 225 mm.	EAL63225	927,00
125 - 500 mm.	EALDO125	2.140,00
125 - 500 mm.	EALTR125	2.774,00

RASPADOR TURBO



Corte do tubo.



Raspagem do tubo.



DIMENSÕES	COD.	€
32 mm.	ERATU032	335,90
40 mm.	ERATU040	372,60
50 mm.	ERATU050	404,70
63 mm.	ERATU063	404,70

PRENSA MANUAL



DIMENSÕES	COD.	€
20 - 90 mm.	EPM02090	331,30

PRENSA HIDRÁULICA



DIMENSÕES	COD.	€
90 - 225 mm.	EPH90225	2.243,00

MARCADOR PARA TUBO PE



COD.	€
EMARCADO	14,25

RASPADOR PARA TUBO



DIMENSÕES	COD.	€
40 mm.	ERASC037	23,55
62 mm.	ERASC062	28,50

TOALHITAS DE LIMPEZA (100 unid.)



COD.	€
ETISSUE1	39,60

CHAVE PARA TOMADA EM CARGA



COD.	€
ELLAVTOM	Consultar

LIQUÍDO DE LIMPEZA (1 litro)



COD.	€
ELIFOXIT	22,55

CORTA TUBOS



DIMENSÕES	COD.	€
6 - 76 mm.	ECORT006	271,70
50 - 140 mm.	ECORT050	349,65
100 - 160 mm.	ECORT100	437,90
180 - 315 mm.	ECORT180	2.371,85

VÁLVULAS DE FUNDIÇÃO

Os setores de águas potáveis e residuais, rega e climatização são aqueles para os quais a ATUSA orienta o desenvolvimento dos seus produtos. Com esta orientação e uma família já consolidada de produtos de fundição, que inclui válvulas de passagem, retenção, filtros, válvulas de fundo e borboleta, juntamos mais novidades orientadas para o setor de condução de fluídos.

Juntas de expansão metálicas para completar a gama de uniões anti-vibráticas, mais as uniões para tubagem de PVC e polietileno vêm completar a gama de válvulas de fundição e tornar a ATUSA um fornecedor de confiança para os clientes mais exigentes neste setor de atividade.



ATUSA



VÁLVULAS DE
FUNDIÇÃO

VÁLVULAS DE
FUNDIÇÃO

DN 200

500

VÁLVULA DE COMPORTA CUNHA ELÁSTICA - FLANGEADA

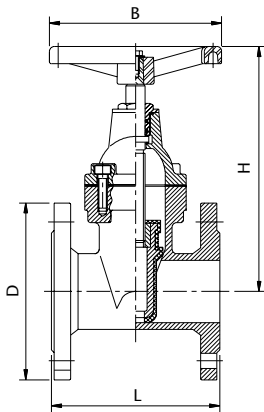

Flanges:

- PN 10
- PN 10/16
- PN 16

DN	D mm.	L mm.	B mm.	H mm.	Nº FUROS x d mm.	COD.	€
40	150	140	200	220	4 x 19	VF500040	95,45
50	165	150	200	220	4 x 19	VF500050	99,85
65	185	170	200	255	4 x 19	VF500065	122,85
80	200	180	254	280	8 x 19	VF500080	154,60
100	220	190	254	320	8 x 19	VF500100	190,30
125	250	200	315	355	8 x 19	VF500125	264,70
150	285	210	315	400	8 x 23	VF500150	349,80
200	340	230	315	510	8 x 23	VF500201	524,85
200	340	230	315	510	12 x 23	VF500200	524,85
250	395	250	406	600	12 x 23	VF500251	785,55
250	405	250	406	600	12 x 28	VF500250	785,55
300	445	270	406	680	12 x 23	VF500301	1.182,30
300	460	270	406	680	12 x 28	VF500300	1.182,30
350	505	290	500	810	16 X 23	VF500351	2.217,00
350	520	290	500	810	16 x 28	VF500350	2.217,00
400	565	310	500	890	16 x 28	VF500401	2.731,80
400	580	310	500	890	16 x 31	VF500400	2.731,80
NEW 450	615	330	500	990	20 x 28	VF500451	4.980,50
NEW 450	650	330	500	990	20 x 31	VF500450	4.980,50
500	670	350	650	1065	20 x 28	VF500501	5.545,35
500	715	350	650	1065	20 x 34	VF500500	5.545,35
NEW 600	780	390	650	1270	20 x 31	VF500601	10.985,00
NEW 600	840	390	650	1270	20 x 37	VF500600	10.985,00

CARACTERÍSTICAS TÉCNICAS

Pressão de serviço: PN 16.
 Temperatura de serviço: 0° C a 80° C.
 Construídas de acordo: DIN 3352/F4 (EN 1171).
 Flanges de acordo: DIN EN 1092-2 PN 10/16.
 Distância entre flanges: DIN 3202-1 F4
 (EN 558-1 Série 14).
 Proteção interna e externa "EPOXY".

COMPONENTES

Corpo: Fundição Nodular GGG 50 (EN-GJS-500-7)
Tampa: Fundição Nodular GGG 50 (EN-GJS-500-7)
Comporta: Fundição Nodular GGG 50 (EN-GJS-500-7)
Revestimento da comporta: Borracha EPDM
Eixo: Aço Inox AISI 420
Juntas: NBR
Parafusos: Aço Inoxidável A2
Volante: Fundição Nodular GGG 50 (EN-GJS-500-7)

505

QUADRA DE MANOBRA PARA VÁLVULA DE COMPORTA Ref. 500

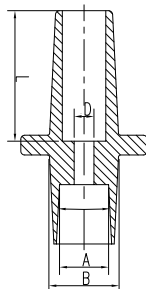

DN	A mm.	B mm.	D mm.	L mm.	COD.	€
40 - 50 - 65	14	30	10	63	VF505050	5,40
80	17	36	10	63	VF505080	5,40
100 - 125 - 150	19	41	10	63	VF505125	6,45
200	24	51	10	63	VF505200	6,45
250 - 300 - 350 - 400	27	58	12	63	VF505250	9,70
500	32	56	14	75	VF505500	9,70

COMPONENTES

Corpo: Fundição Nodular GGG 50 (EN-GJS-500-7)

508

EXTENSÃO PARA VÁLVULA DE COMPORTA Ref. 500



COMPONENTES

Corpo: Aço Galvanizado
Encaixe e cabeça do eixo: Fundição Nodular
Tubo protetor: PVC

DN	COMPRIMENTO					
	600 mm.		1000 mm.		1500 mm.	
	COD.	€	COD.	€	COD.	€
40 - 50 - 65	VFE06040	113,60	VFE10040	113,60	VFE15040	170,10
80	VFE06080	113,60	VFE10080	113,60	VFE15080	170,10
100 - 125 - 150	VFE06100	113,60	VFE10100	113,60	VFE15100	170,10
200	VFE06200	132,65	VFE10200	132,65	VFE15200	201,40
250 - 300 - 350 - 400	VFE06250	190,80	VFE10250	190,80	VFE15250	285,75

502

VÁLVULA DE COMPORTA CUNHA ELÁSTICA FUSO ASCENDENTE – FLANGEADA



DN	D mm.	L mm.	M mm.	H mm.	Nº FUROS x d mm.	COD.	€
50	165	150	200	315	4 x 19	VF502050	172,25
65	185	170	200	325	4 x 19	VF502065	222,50
80	200	180	200	355	8 x 19	VF502080	259,80
100	220	190	254	415	8 x 19	VF502100	330,95
125	250	200	315	490	8 x 19	VF502125	452,10
150	285	210	315	550	8 x 23	VF502150	554,75
200	340	230	315	670	12 x 23	VF502200	882,90
250	405	250	406	845	12 x 28	VF502250	1.212,75
300	460	270	406	1100	12 x 28	VF502300	1.816,85

Flanges: ■ PN 10/16 ■ PN 16

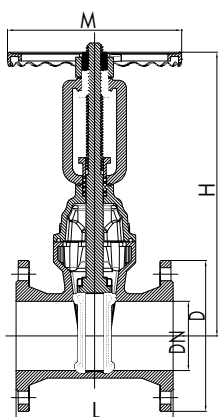

CARACTERÍSTICAS TÉCNICAS

Pressão de serviço: PN 16.
 Temperatura de serviço: 0° C a 80° C.
 Construídas de acordo: DIN 3352/F4 (EN 1171).
 Flanges conforme: DIN EN 1092-2 PN 10/16.
 Distância entre flanges: DIN 3202-1 F4
 (EN 558-1 Série 14).
 Proteção interna e externa "EPOXY".

COMPONENTES

Corpo: Fundição Nodular GGG 50 (EN-GJS-500-7)
Tampão: Fundição Nodular GGG 50 (EN-GJS-500-7)
Comporta: Fundição Nodular GGG 50 (EN-GJS-500-7)
Revestimento da comporta: EPDM
Ponte: Fundição Nodular GGG 50 (EN-GJS-500-7)
Pressa: Fundição Nodular GGG 50 (EN-GJS-500-7)
Eixo: Aço inoxidável AISI 420
Junta: NBR
Empanque: PTFE
Porca do eixo: Latão
Anilha do volante: Aço Inoxidável AISI 304
Volante: Fundição Nodular GGG 50 (EN-GJS-500-7)

501

VÁLVULA DE COMPORTA CUNHA ELÁSTICA – ROSCADA



Ø	L mm.	F mm.	H mm.	COD.	€
3/4"	95	16	145	VF501004	80,05
1"	105	20	145	VF501005	83,65
1 1/4"	120	20	149	VF501006	93,85
1 1/2"	130	25	172	VF501007	113,25
2"	150	25	190	VF501008	123,75

	COD.	€
Ref. 502 Quadra	VF502000	4,60
Ref. 503 Volante	VF503000	7,45

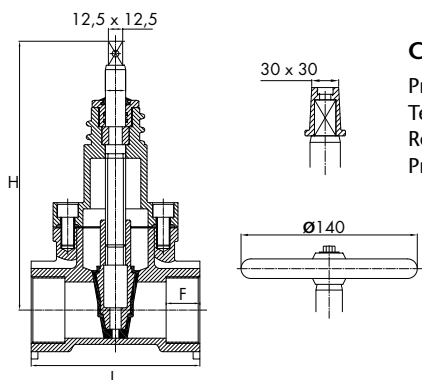

CARACTERÍSTICAS TÉCNICAS

Pressão de serviço: PN 16.
 Temperatura de serviço: 0° C a 80° C.
 Roscas Fêmea cilíndrica.
 Proteção interna e externa "EPOXY".

COMPONENTES

Corpo: Fundição Nodular GGG 50 (EN-GJS-500-7)
Tampa: Fundição Nodular GGG 50 (EN-GJS-500-7)
Comporta: Latão
Revestimento da comporta: Goma EPDM
Eixo: Aço Inoxidável AISI 420
Junta: NBR
Volante: Aço Carbono
Quadra: Fundição Nodular GGG 50 (EN-GJS-500-7)

503

VÁLVULA DE COMPORTA FECHO METÁLICO – FLANGEADA

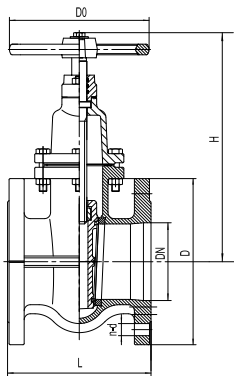

DN	D mm.	L mm.	DO mm.	H mm.	Nº FUROS x d mm.	COD.	€
40	150	140	130	195	4 x 19	VF503040	132,05
50	165	150	130	205	4 x 19	VF503050	142,35
65	185	170	130	225	4 x 19	VF503065	166,00
80	200	180	150	252	8 x 19	VF503080	188,10
100	220	190	185	294	8 x 19	VF503100	245,70
125	250	200	185	350	8 x 19	VF503125	322,85
150	285	210	190	411	8 x 23	VF503150	431,90
200	340	230	220	496	8 x 23	VF503201	701,65
250	395	250	310	576	12 x 23	VF503251	1.131,40
300	455	270	310	678	12 x 23	VF503301	1.575,60

Flanges: ■ PN 10 ■ PN 10/16

CARACTERÍSTICAS TÉCNICAS

Pressão de serviço: PN10.
 Temperatura de serviço: 0° C a 80° C.
 Construídas conforme: DIN 3352/F4.
 Flanges conforme: DIN EN 1092-2 PN10/16.
 Distância entre flanges: DIN 3202-1 F4 (EN 558-1 Serie 14).

COMPONENTES

Corpo: Fundição Gris GG 25 (EN-GJL-250)
Tampa: Fundição Gris GG 25 (EN-GJL-250)
Comporta: Fundição Gris GG 25 (EN-GJL-250)
Anel de assento corpo: Latão
Anel de assento comporta: Latão
Eixo: Aço inoxidável AISI 420
Volante: Fundição Gris GG 25 (EN-GJL-250)

504

VÁLVULA DE COMPORTA FECHO METÁLICO FUSO ASCENDENTE – FLANGEADA

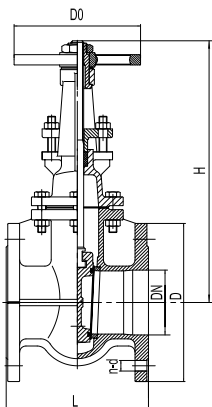

DN	D mm.	L mm.	DO mm.	H mm.	Nº FUROS x d mm.	COD.	€
40	150	140	160	244 / 295	4 x 19	VF504040	197,55
50	165	150	160	254 / 315	4 x 19	VF504050	213,90
65	185	170	160	294 / 371	4 x 19	VF504065	241,75
80	200	180	160	331 / 424	8 x 19	VF504080	302,40
100	220	190	200	385 / 500	8 x 19	VF504100	407,40
125	250	200	200	457 / 598	8 x 19	VF504125	549,80
150	285	210	250	545 / 711	8 x 23	VF504150	707,35
200	340	230	250	683 / 901	8 x 23	VF504201	1.070,90
200	340	230	250	683 / 901	12 x 23	VF504200	1.070,90
250	395	250	320	823 / 1.093	12 x 23	VF504251	1.697,45
250	405	250	320	823 / 1.093	12 x 28	VF504250	1.697,45
300	445	270	320	952 / 1.273	12 x 23	VF504301	2.492,60
300	460	270	320	952 / 1.273	12 x 28	VF504300	2.492,60

Flanges: ■ PN 10 ■ PN 16 ■ PN 10/16

CARACTERÍSTICAS TÉCNICAS

Pressão de serviço: PN16 .
 Temperatura de serviço: 0° C a 180° C.
 Construídas conforme: DIN 3352/F4.
 Flanges conforme: DIN EN 1092-2 PN 10/16.
 Distância entre flanges: DIN 3202-1 F4 (EN 558-1 Serie 14).

COMPONENTES

Corpo: Fundição Nodular GGG 50 (EN-GJS-500-7)
Tampa: Fundição Nodular GGG 50 (EN-GJS-500-7)
Comporta: Fundição Nodular GGG 50 (EN-GJS-500-7)
Anel de assento corpo: Aço inoxidável AISI 304
Anel de assento comporta: Aço inoxidável AISI 304
Eixo: Aço inoxidável AISI 420
Junta: Grafite
Pressa: Fundição Nodular GGG 50 (EN-GJS-500-7)
Empanque: Grafite
Porca do eixo: Latão
Volante: Fundição Gris GG 25 (EN-GJL-250)

510 FILTRO EM "Y" FLANGEADO

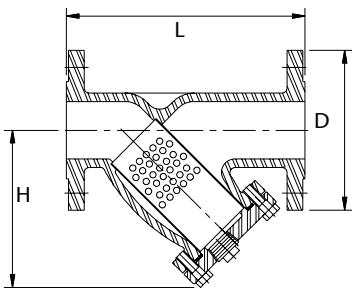

DN	D mm.	L mm.	H mm.	Nº FUROS x d mm.	FUROS MALHA d mm.	COD.	€
32	140	180	111	4 x 19	1,5	VF510032	43,35
40	150	200	118	4 x 19	1,5	VF510040	46,75
50	165	230	178	4 x 19	1,5	VF510050	77,20
65	185	290	211	4 x 19	1,5	VF510065	110,00
80	200	310	202	8 x 19	1,5	VF510080	126,85
100	220	350	226	8 x 19	3	VF510100	165,75
125	250	400	264	8 x 19	3	VF510125	243,25
150	285	480	309	8 x 23	3	VF510150	336,50
200	340	600	410	8 x 23	3	VF510201	600,70
200	340	600	410	12 x 23	3	VF510200	600,70
250	395	730	444	12 x 23	3	VF510251	1.010,60
250	405	730	444	12 x 28	3	VF510250	1.010,60
300	445	850	486	12 x 23	3	VF510301	1.492,70
300	460	850	486	12 x 28	3	VF510300	1.492,70
350	520	980	595	16 x 28	3	VF510350	2.599,80
400	580	1100	673	16 x 31	3	VF510400	4.506,45
500	715	1250	910	20 x 34	3	VF510500	11.581,75

Flanges: ■ PN 10 ■ PN 10/16 ■ PN 16

CARACTERÍSTICAS TÉCNICAS

Pressão de serviço: PN 16.
 Temperatura de serviço: -10° C a 80° C.
 Flanges conforme: DIN EN 1092-2 PN 10/16.
 Distância entre flanges: DIN 3202-1 F1
 (EN 558-1 Série 1).
 Proteção interna e externa "EPOXY".

COMPONENTES

Corpo: Fundição Gris GG 25 (EN-GJL-250)
Tampa: Fundição Gris GG 25 (EN-GJL-250)
Junta: Grafite
Malha: Aço inoxidável AISI 304
Tampão: Fundição Nodular GGG 40 (EN-GJS-400-15)

511 FILTRO EM "Y" ROSCADO

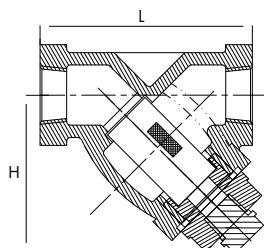

Ø	L mm.	H mm.	FUROS MALHA d mm.	COD.	€
1/2"	76	52	1	VF511003	14,65
3/4"	102	65	1	VF511004	18,80
1"	124	81	1	VF511005	25,90
1 1/4"	132	97	1	VF511006	36,80
1 1/2"	146	103	1	VF511007	43,90
2"	184	117	1	VF511008	61,50
2 1/2"	229	145	1	VF51100A	91,55
3"	254	172	1	VF51100B	112,10

CARACTERÍSTICAS TÉCNICAS

Pressão de serviço: PN 16.
 Temperatura de serviço: -10° C a 200° C.
 Rosca F/F BSP.

COMPONENTES

Corpo: Fundição Nodular GGG 40 (EN-GJS-400-15)
Tampão: Fundição Nodular GGG 40 (EN-GJS-400-15)
Malha: Aço inoxidável AISI 304
Junta: Grafite

520

VÁLVULA DE RETENÇÃO DUPLO PRATO AÇO INOXIDÁVEL AISI 316

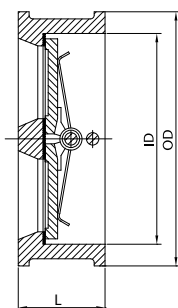

DN	L mm.	OD mm.	ID mm.	COD.	€
40	43	92	65	VF520040	41,95
50	54	109	65	VF520050	43,10
65	54	129	80	VF520065	50,45
80	57	144	94	VF520080	66,95
100	64	164	117	VF520100	83,45
125	70	194	145	VF520125	112,60
150	76	220	170	VF520150	165,70
200	95	275	224	VF520200	302,50
250	108	328	265	VF520250	438,10
300	143	378	312	VF520300	573,60
350	184	438	360	VF520350	1.009,70
400	191	489	410	VF520400	1.477,15
NEW 450	203	532	450	VF520450	2.395,00
NEW 500	213	585	500	VF520500	2.874,20
NEW 600	222	685	624	VF520600	4.890,00

CARACTERÍSTICAS TÉCNICAS

Pressão de serviço: PN 16.
 Temperatura de serviço: -10° C a 80° C.
 Adaptável a flanges PN 10/16.
 Dist. Flanges: DIN 3202-1 (EN 558-1 Série 50).
 Proteção interna e externa "EPOXY".

COMPONENTES

Corpo: Fundição Gris GG 25 (EN-GJL-250)
Prato: Aço Inoxidável AISI 316 (CF8M)
Assento: Borracha Vulcanizada NBR
Eixos: Aço Inoxidável AISI 316
Anilha: PTFE
Mola: Aço Inoxidável AISI 316

521

VÁLVULA DE RETENÇÃO DUPLO PRATO FUNDIÇÃO NODULAR

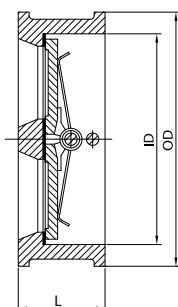

DN	L mm.	OD mm.	ID mm.	COD.	€
40	43	92	65	VF521040	34,85
50	54	109	65	VF521050	35,15
65	54	129	80	VF521065	42,70
80	57	144	94	VF521080	57,55
100	64	164	117	VF521100	71,25
125	70	194	145	VF521125	96,75
150	76	220	170	VF521150	131,95
200	95	275	224	VF521200	220,45
250	108	328	265	VF521250	328,50
300	143	378	312	VF521300	456,95
350	184	438	360	VF521350	803,90
400	191	489	410	VF521400	1.028,65
NEW 450	203	532	450	VF521450	1.625,00
NEW 500	213	585	500	VF521500	1.724,80
NEW 600	222	685	624	VF521600	2.989,00

CARACTERÍSTICAS TÉCNICAS

Pressão de serviço: PN 16.
 Temperatura de serviço: -10° C a 80° C.
 Adaptável a flanges PN 10/16.
 Dist. Flanges: DIN 3202-1 (EN 558-1 Série 50).
 Proteção interna e externa "EPOXY".

COMPONENTES

Corpo: Fundição Gris GG 25 (EN-GJL-250)
Prato: Fundição nodular GGG 40 (EN-GJS-400-15)
Assento: Borracha Vulcanizada NBR
Eixos: Aço Inoxidável AISI 304
Anilha: PTFE
Mola: Aço Inoxidável AISI 304

550

VÁLVULA DE RETENÇÃO DE BOLA - FLANGEADA

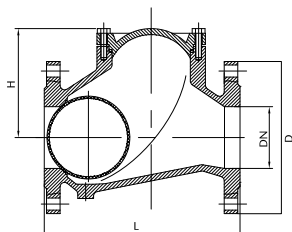

Flanges:

- PN 10
- PN 10/16
- PN 16

DN	D mm.	L mm.	H mm.	Nº FUROS x d mm.	COD.	€
40	150	180	98	4 x 19	VF550040	109,35
50	165	200	106	4 x 19	VF550050	113,90
65	185	240	129	4 x 19	VF550065	149,55
80	200	260	146	8 x 19	VF550080	186,55
100	220	300	194	8 x 19	VF550100	244,20
125	250	350	207	8 x 19	VF550125	361,30
150	285	400	240	8 x 23	VF550150	465,10
200	340	500	322	8 x 23	VF550201	920,25
200	340	500	322	12 x 23	VF550200	920,25
250	395	600	388	12 x 23	VF550251	1.590,65
250	405	600	388	12 x 28	VF550250	1.590,65
300	445	700	458	12 x 23	VF550301	2.291,15
300	460	700	458	12 x 28	VF550300	2.291,15

CARACTERÍSTICAS TÉCNICAS

Pressão de serviço: PN 16.
 Temperatura de serviço: -10° C a 80° C.
 Flanges de acordo: DIN EN 1092-2 PN 10/16.
 Dist. entre flanges: DIN 3202-1 F6 (EN 558-1 Série 48).
 Proteção interna e externa "EPOXY".

COMPONENTES

Corpo: Fundição Nodular GGG 40 (EN-GJS-400-15)
Tampa: Fundição Nodular GGG 40 (EN-GJS-400-15)
Bola: Metal + NBR
Junta: NBR
Parafusos: Aço Inoxidável A2

555

VÁLVULA DE RETENÇÃO DE BOLA ROSCADA

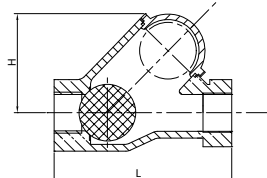

Ø	L mm.	H mm.	COD.	€
1"	125	75	VF555005	44,85
1 1/4"	132	75	VF555006	48,25
1 1/2"	145	85	VF555007	59,95
2"	174	116	VF555008	89,05
2 1/2"	200	140	VF55500A	128,00
3"	243	160	VF55500B	174,40

CARACTERÍSTICAS TÉCNICAS

Pressão de serviço: PN 16.
 Temperatura de serviço: -10° C a 80° C.
 Rosca fêmea cilíndrica.
 Proteção interna e externa "EPOXY".

COMPONENTES

Corpo: Fundição Nodular GGG 40 (EN-GJS-400-15)
Tampa: Fundição Nodular GGG 40 (EN-GJS-400-15)
Bola: Metal + NBR
Junta: NBR
Parafusos: Aço Inoxidável A2

530

VÁLVULA DE RETENÇÃO DE CHARNEIRA REVESTIDA

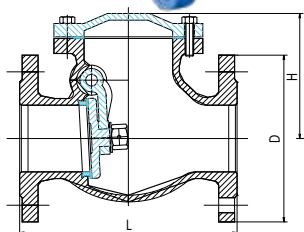

Flanges:

- PN 10
- PN 10/16
- PN 16

DN	D mm.	L mm.	H mm.	Nº FUROS x d mm.	COD.	€
50	165	200	127	4 x 19	VF530050	96,10
65	185	240	137	4 x 19	VF530065	144,10
80	200	260	150	8 x 19	VF530080	183,45
100	220	300	164	8 x 19	VF530100	220,15
125	250	350	185	8 x 19	VF530125	340,35
150	285	400	205	8 x 23	VF530150	492,10
200	340	500	249	8 x 23	VF530201	654,65
200	340	500	249	12 x 23	VF530200	654,65
250	395	600	301	12 x 23	VF530251	1.071,70
250	405	600	301	12 x 28	VF530250	1.071,70
300	445	700	333	12 x 23	VF530301	1.546,00
300	460	700	333	12 x 28	VF530300	1.546,00

CARACTERÍSTICAS TÉCNICAS

Pressão de serviço: PN 16.
 Temperatura de serviço: -10° C a 80° C.
 Flanges conforme: DIN EN 1092-2 PN 10/16.
 Dist. entre flanges: DIN 3202-1 F6 (EN 558-1 Série 48).
 Proteção interna e externa "EPOXY".

COMPONENTES

Corpo: Fundição Gris GG 25 (EN-GJL-250)
Tampa: Fundição Gris GG 25 (EN-GJL-250)
Disco: Fundição Gris GG 25 (EN-GJL-250)
Anel de assento do corpo: Latão
Anel de assento do disco: EPDM
Junta: Grafite

560

VÁLVULA DE RETENÇÃO DE DISCO

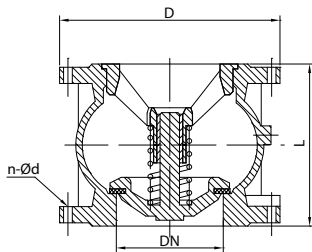

DN	D mm.	L mm.	Nº FUROS x d mm.	COD.	€
50	165	100	4 x 19	VF560050	74,30
65	185	120	4 x 19	VF560065	90,65
80	200	140	8 x 19	VF560080	107,15
100	220	170	8 x 19	VF560100	135,10
125	250	200	8 x 19	VF560125	211,00
150	285	230	8 x 23	VF560150	293,55
200	340	300	8 x 23	VF560201	474,30
200	340	300	12 x 23	VF560200	474,30
250	395	370	12 x 23	VF560251	683,15
250	405	370	12 x 28	VF560250	683,15
300	445	410	12 x 23	VF560301	1.108,60
300	460	410	12 x 28	VF560300	1.108,60

Flanges: ■ PN 10 ■ PN 10/16 ■ PN 16

CARACTERÍSTICAS TÉCNICAS

Pressão de serviço: PN 16.
 Temperatura de serviço: -10° C a 80° C.
 Flanges de acordo: DIN EN 1092-2 PN 10/16.
 Proteção interna e externa "EPOXY".

COMPONENTES

Corpo: Fundição Nodular GGG 40 (EN-GJS-400-15)
Disco: Fundição Nodular GGG 40 (EN-GJS-400-15)
Guia: Fundição Nodular GGG 40 (EN-GJS-400-15)
Junta de fecho: NBR
Mola: Aço Inoxidável AISI 304

565

FILTRO PARA VÁLVULA DE RETENÇÃO DE DISCO

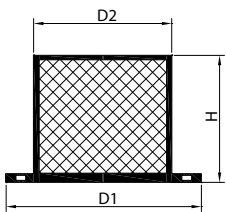

DN	D1 mm.	D2 mm.	H mm.	COD.	€
50	156	111	80	VF565050	23,45
65	176	131	100	VF565065	28,60
80	192	148	120	VF565080	32,90
100	212	168	150	VF565100	43,90
125	242	198	175	VF565125	55,10
150	276	222	200	VF565150	69,40
200	332	278	250	VF565200	99,55
250	385	329	300	VF565250	138,65
300	445	384	350	VF565300	245,75

COMPONENTES: **Filtro:** Aço Zincado **Parafusos:** Aço Inoxidável

570

VÁLVULA DE BOLA

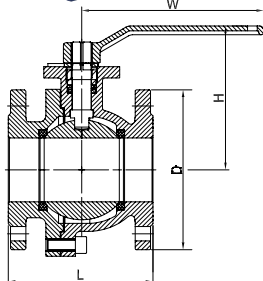

DN	D mm.	L mm.	H mm.	W mm.	Nº FUROS x d mm.	COD.	€
15	95	115	86	130	4 x 14	VF570015	59,85
20	105	120	95	130	4 x 14	VF570020	77,30
25	115	125	100	160	4 x 14	VF570025	90,00
32	140	130	105	160	4 x 19	VF570032	104,15
40	150	140	121	220	4 x 19	VF570040	124,65
50	165	150	136	250	4 x 19	VF570050	146,65
65	185	170	161	350	4 x 19	VF570065	231,15
80	200	180	180	350	8 x 19	VF570080	265,10
100	220	190	222	400	8 x 19	VF570100	380,15
125	250	325	260	600	8 x 19	VF570125	740,10
150	285	350	280	600	8 x 23	VF570150	955,70
200	340	400	340	700	12 x 23	VF570200	1.694,40

Flanges:

■ PN 10/16
■ PN 16

CARACTERÍSTICAS TÉCNICAS

Pressão de serviço: PN 16.
 Temperatura de serviço: 0° C a 150° C.
 Flanges de acordo: DIN EN 1092-2 PN 10/16.
 Distância entre flanges: DIN 3202-1 F18 (EN 558-1 Série 27).
 Placa ISO 5211.
 Passagem Total.

COMPONENTES

Corpo: Fundição Gris GG 25 (EN-GJL-250)
Tampa: Fundição Gris GG 25 (EN-GJL-250)
Bola: Aço Inox AISI 304
Assento: PTFE
Eixo: Aço Inox AISI 304
Junta do corpo: PTFE
Empanque: PTFE
Manipulo: Fundição Gris GG 25 (EN-GJL-250)

580

VÁLVULA DE GLOBO

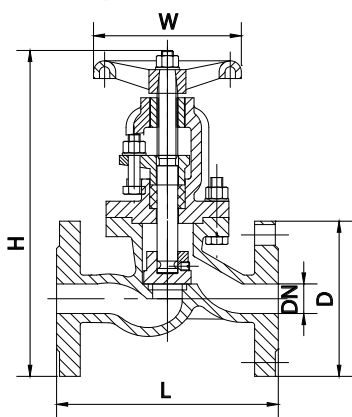

DN	D mm.	L mm.	H mm.	W mm.	Nº FUROS x d mm.	COD.	€
15	95	130	182	120	4 X 14	VF580015	39,95
20	105	150	185	120	4 X 14	VF580020	47,15
25	115	160	201	120	4 X 14	VF580025	56,75
32	140	180	253	120	4 x 19	VF580032	68,10
40	150	200	254	140	4 x 19	VF580040	88,90
50	165	230	277	160	4 x 19	VF580050	105,35
65	185	290	312	160	4 x 19	VF580065	138,90
80	200	310	342	175	8 x 19	VF580080	230,00
100	220	350	378	195	8 x 19	VF580100	286,60
125	250	400	447	245	8 x 19	VF580125	437,15
150	285	480	503	315	8 x 23	VF580150	635,30
200	340	600	591	400	12 x 23	VF580200	1.070,85

Flanges: ■ PN 10/16 ■ PN 16

CARACTERÍSTICAS TÉCNICAS

Pressão de serviço: PN 16.
 Temperatura de serviço: 0° C a 120° C.
 Flanges conforme: DIN EN 1092-2 PN 10/16.
 Dist. entre flanges: DIN 3202-1 F1 (EN 558 série 1).

COMPONENTES

Corpo: Fundição Gris GG 25 (EN-GJL-250)
Tampão: Fundição Gris GG 25 (EN-GJL-250)
Junta: Grafite
Assento corpo: Aço Inoxidável AISI 304
Assento disco: Aço Inoxidável AISI 304
Disco: Fundição Gris GG 25 (EN-GJL-250)
Empanque: Grafite
Pressa: Fundição Gris GG 25 (EN-GJL-250)
Eixo: Aço Inoxidável AISI 420
Volante: Fundição Gris GG 25 (EN-GJL-250)

700

JUNTA DESMONTAGEM TELESCÓPICA

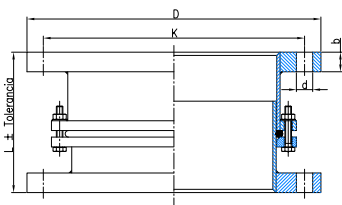

DN	Ø	L mm.	TOLERANCIA mm.	D mm.	K mm.	Nº FUROS x d mm.	b mm.	COD.	€
50	2"	180	±30	165	125	4 x 18	18	VF700050	232,30
65	2 1/2"	180	±30	185	145	8 x 18	18	VF700065	258,35
80	3"	180	±30	200	160	8 x 18	20	VF700080	273,55
100	4"	180	±30	220	180	8 x 18	20	VF700100	286,95
125	5"	180	±30	250	210	8 x 18	22	VF700125	308,50
150	6"	180	±30	285	240	8 x 22	22	VF700150	323,90
200	8"	220	±40	340	295	8 x 22	24	VF700201	447,00
200	8"	220	±40	340	295	12 x 22	24	VF700200	506,40
250	10"	230	±40	395	350	12 x 22	26	VF700251	623,05
250	10"	230	±40	405	355	12 x 26	26	VF700250	706,70
300	12"	230	±40	445	400	12 x 22	26	VF700301	721,95
300	12"	230	±40	460	410	12 x 26	28	VF700300	807,60
350	14"	270	±40	505	460	16 x 22	28	VF700351	966,85
350	14"	270	±40	520	470	16 x 26	30	VF700350	1.076,30
400	16"	270	±40	565	515	16 x 26	32	VF700401	1.227,05
400	16"	270	±40	580	525	16 x 30	32	VF700400	1.386,30
500	20"	270	±40	670	620	20 x 26	38	VF700501	1.738,20
500	20"	270	±40	715	650	20 x 33	38	VF700500	1.938,75
600	24"	330	±50	780	725	20 x 30	36	VF700601	2.431,05
600	24"	330	±50	840	770	20 x 36	38	VF700600	2.675,70

Flanges: ■ PN 10 ■ PN 10/16 ■ PN 16

CARACTERÍSTICAS TÉCNICAS

Pressão de serviço: PN 10 e PN 16
 Flanges conforme: DIN 2576 PN 10/16 e
 DIN 2502 PN 16

COMPONENTES

Virola: Aço Inoxidável AISI 304
Flanges: Aço carbono S235 JR
Junta: NBR
Parafusos: Aço zincado 8.8
Pintura: Epoxy

OUTRAS CONFIGURAÇÕES, DIÂMETROS E PRESSÕES – SOB CONSULTA.

900/901/910/911/930/931

VÁLVULA DE BORBOLETA
TIPO WAFER

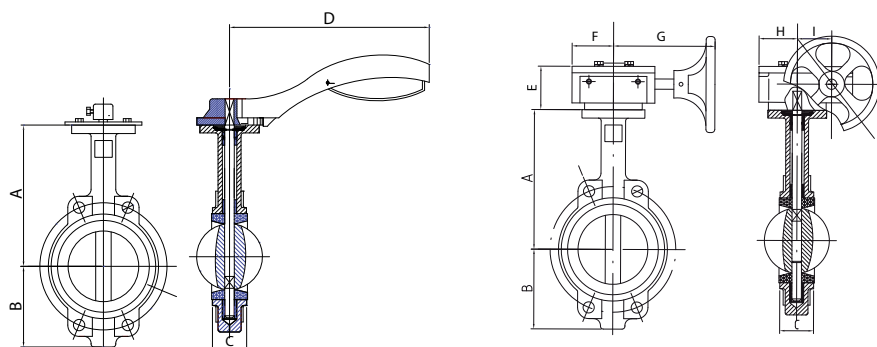

DN	32	40	50	65	80	100	125	150	200	250	300	350	400	450	500	600
A mm.	150	150	161	175	181	200	213	226	260	292	337	368	400	422	480	562
B mm.	65	65	80	89	95	114	127	139	175	203	242	267	309	328	361	459
C mm.	33	33	43	46	46	52	56	56	60	68	78	78	102	114	127	154
D mm.	170	170	170	170	170	170	220	220	260	350	350	-	-	-	-	-
E mm.	60	60	60	60	60	60	60	60	75	75	75	75	97	97	120	123
F mm.	52	52	52	52	52	52	52	52	75	75	75	75	112	112	128	131
G mm.	153	153	153	153	153	153	153	153	215	215	235	235	277	277	283	305
H mm.	52	52	52	52	52	52	52	52	75	75	81	81	112	112	128	131
I mm.	45	45	45	45	45	45	45	45	63	63	80	80	108	108	115	194
J mm.	135	135	135	135	145	145	145	145	270	270	270	270	380	380	380	385

CARACTERÍSTICAS TÉCNICAS

Pressão de serviço: PN 16.
 Temperatura: * EPDM: -10° C a 120° C.
 * NBR: -10° C a 80° C.
 Adequada para flanges PN 10 e PN 16.
 Dist. entre flanges: EN558 Série 20.
 Proteção externa "EPOXY".
 Flange para atuador ISO 5211.

COMPONENTES

Corpo: Fundição Nodular GGG 40 (EN-GJS-400-15)
Disco: * Aço Inoxidável AISI 316 (CF8M)
 * Fundição Nodular Zincada
Elastômero: * EPDM
 * NBR
Eixo: Aço Inoxidável AISI 416
V. Redutor: Fundição Gris GG 25 (EN-GJL-250)
Manete: Alumínio
O-Ring: * EPDM
 * NBR

DN	Ref. 900		Ref. 901		Ref. 910		Ref. 911		Ref. 930		Ref. 931	
	Corpo Fund. Nodular Disco Inox EPDM Manete		Corpo Fund. Nodular Disco Inox EPDM V. Redutor		Corpo Fund. Nodular Disco Ductil EPDM Manete		Corpo Fund. Nodular Disco Ductil EPDM V. Redutor		Corpo Fund. Nodular Disco Inox NBR Manete		Corpo Fund. Nodular Disco Inox NBR V. Redutor	
	COD.	€	COD.	€	COD.	€	COD.	€	COD.	€	COD.	€
32	VF900032	46,35	VF901032	89,60	VF910032	39,40	VF911032	83,75	VF930032	46,35	VF931032	89,60
40	VF900040	46,35	VF901040	89,60	VF910040	39,40	VF911040	83,75	VF930040	46,35	VF931040	89,60
50	VF900050	46,35	VF901050	89,60	VF910050	39,40	VF911050	83,75	VF930050	46,35	VF931050	89,60
65	VF900065	56,40	VF901065	101,25	VF910065	47,55	VF911065	93,20	VF930065	56,40	VF931065	101,25
80	VF900080	63,00	VF901080	108,10	VF910080	51,15	VF911080	97,50	VF930080	63,00	VF931080	108,10
100	VF900100	91,90	VF901100	134,15	VF910100	67,15	VF911100	117,15	VF930100	91,90	VF931100	134,15
125	VF900125	128,20	VF901125	170,80	VF910125	96,45	VF911125	138,10	VF930125	128,20	VF931125	170,80
150	VF900150	153,70	VF901150	198,25	VF910150	112,95	VF911150	151,15	VF930150	153,70	VF931150	198,25
200	VF900200	277,20	VF901200	357,00	VF910200	166,05	VF911200	243,60	VF930200	277,20	VF931200	357,00
250	VF900250	438,80	VF901250	537,95	VF910250	262,60	VF911250	321,40	VF930250	438,80	VF931250	537,95
300	VF900300	686,50	VF901300	826,40	VF910300	365,60	VF911300	436,00	VF930300	686,50	VF931300	826,40
350			VF901350	1.190,70			VF911350	580,00				
400			VF901400	2.061,50			VF911400	1.126,05				
450			VF901450	2.654,00			VF911450	1.579,00				
500			VF901500	3.197,70			VF911500	1.773,90				
600			VF901600	6.185,00			VF911600	3.691,00				

950/951/960/961/970/971

VÁLVULA DE BORBOLETA TIPO LUG

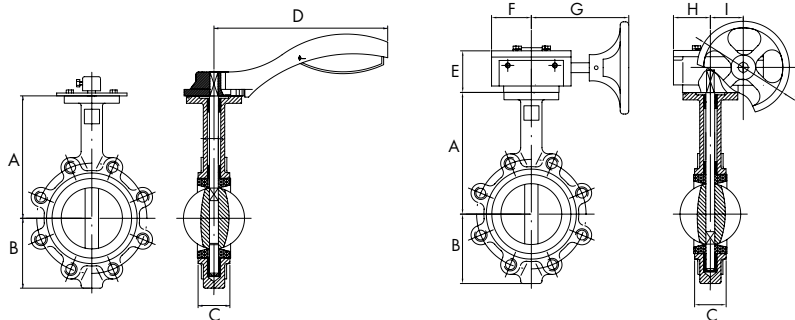

DN	32	40	50	65	80	100	125	150	200	250	300	350	400
A mm.	142	142	130	140	148	164	213	226	260	292	337	369	400
B mm.	72	72	67	71	91	99	127	139	175	203	242	263	309
C mm.	33	33	43	46	46	52	56	56	60	68	78	78	102
D mm.	170	170	170	170	170	170	220	220	260	350	350	-	-
E mm.	60	60	60	60	60	60	60	60	75	75	75	83	97
F mm.	52	52	52	52	52	52	52	52	75	75	75	81	112
G mm.	153	153	153	153	153	153	153	153	215	215	235	227	277
H mm.	52	52	52	52	52	52	52	52	75	75	81	81	112
I mm.	45	45	45	45	45	45	45	45	63	63	80	80	108
J mm.	135	135	135	135	145	145	145	145	270	270	270	270	380

CARACTERÍSTICAS TÉCNICAS

Pressão de serviço: PN 16.
 Temperatura: * EPDM: -10° C a 120° C.
 * NBR: -10° C a 80° C.
 Adequada para flanges PN 10 e PN 16.
 Dist. entre flanges: EN558 Série 20.
 Proteção externa "EPOXY".
 Flange para atuador ISO 5211.

COMPONENTES

Corpo: Fundição Nodular GGG 40 (EN-GJS-400-15)
Disco: * Aço Inoxidável AISI 316 (CF8M)
 * Fundição Nodular Zincada
Elastômero: * EPDM
 * NBR
Eixo: Aço Inoxidável AISI 416
V. Redutor: Fundição Gris GG 25 (EN-GJL-250)
Manete: Alumínio
O-Ring: * EPDM
 * NBR

DN	Ref. 950		Ref. 951		Ref. 960		Ref. 961		Ref. 970		Ref. 971	
	Corpo Fund. Nodular Disco Inox EPDM Manete		Corpo Fund. Nodular Disco Inox EPDM V. Redutor		Corpo Fund. Nodular Disco Ductil EPDM Manete		Corpo Fund. Nodular Disco Ductil EPDM V. Redutor		Corpo Fund. Nodular Disco Inox NBR Manete		Corpo Fund. Nodular Disco Inox NBR V. Redutor	
	COD.	€	COD.	€	COD.	€	COD.	€	COD.	€	COD.	€
32	VF950032	64,90	VF951032	126,85	VF960032	55,75	VF961032	109,35	VF970032	64,90	VF971032	126,85
40	VF950040	64,90	VF951040	126,85	VF960040	55,75	VF961040	109,35	VF970040	64,90	VF971040	126,85
50	VF950050	64,90	VF951050	126,85	VF960050	55,75	VF961050	109,35	VF970050	64,90	VF971050	126,85
65	VF950065	77,40	VF951065	150,00	VF960065	66,50	VF961065	119,15	VF970065	77,40	VF971065	150,00
80	VF950080	91,75	VF951080	165,60	VF960080	75,40	VF961080	126,90	VF970080	91,75	VF971080	165,60
100	VF950100	134,65	VF951100	195,40	VF960100	114,55	VF961100	164,60	VF970100	134,65	VF971100	195,40
125	VF950125	184,05	VF951125	245,85	VF960125	143,30	VF961125	197,35	VF970125	184,05	VF971125	245,85
150	VF950150	240,80	VF951150	300,50	VF960150	163,50	VF961150	222,25	VF970150	240,80	VF971150	300,50
200	VF950201	367,00	VF951201	438,50	VF960201	259,50	VF961201	342,65	VF970201	367,00	VF971201	438,50
200	VF950200	367,00	VF951200	438,50	VF960200	259,50	VF961200	342,65	VF970200	367,00	VF971200	438,50
250	VF950251	632,90	VF951251	702,25	VF960251	395,45	VF961251	499,80	VF970251	632,90	VF971251	702,25
250	VF950250	632,90	VF951250	702,25	VF960250	395,45	VF961250	499,80	VF970250	632,90	VF971250	702,25
300	VF950301	984,30	VF951301	1.070,90	VF960301	569,30	VF961301	684,20	VF970301	984,30	VF971301	1.070,90
300	VF950300	984,30	VF951300	1.070,90	VF960300	569,30	VF961300	684,20	VF970300	984,30	VF971300	1.070,90
350			VF951351	1.498,60			VF961351	998,50			VF971351	1.498,60
350			VF951350	1.498,60			VF961350	998,50			VF971350	1.498,60
400			VF951401	2.455,20			VF961401	1.802,00			VF971401	2.455,20
400			VF951400	2.455,20			VF961400	1.802,00			VF971400	2.455,20

Flanges: ■ PN 10 ■ PN 10/16 ■ PN 16

UNIÕES DE EXPANSÃO EM BORRACHA - DUPLA ONDA - TIPO UNIÃO

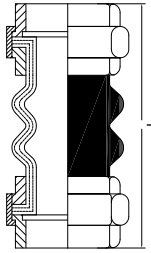

DN	L mm.	COMPRESSÃO AXIAL mm.	ALONGAMENTO AXIAL mm.	DESVÍO LATERAL mm.	DESVÍO ANGULAR GRAUS	COD. EPDM	€
20	200	22	6	22	20	VSMU0020	23,70
25	200	22	6	22	20	VSMU0025	24,40
32	200	22	6	22	20	VSMU0032	33,15
40	200	22	6	22	20	VSMU0040	36,55
50	200	22	6	22	20	VSMU0050	47,40

CARACTERÍSTICAS TÉCNICAS

Pressão de serviço: PN 16.
 Vácuo : 525 mm Hg.
 Temperatura: -20° C a 115° C.
 União com acessórios ferro maleável roscados.

COMPONENTES

Polímero base: EPDM no interior e exterior
 Reforço de nylon com cabo de aço.
 Acessórios rosca BSPT de fundição maleável electro zincados.

Relación Presión / Temperatura

Tª (°C)	-20	20	60	80	115
P (bar)	16	16	16	10	1

UNIÃO DE EXPANSÃO EM BORRACHA – ONDA SIMPLES – FLANGEADA

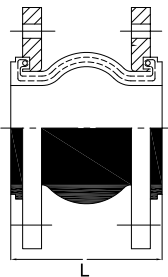

DN	L mm.	COMPRESSÃO AXIAL mm.	ALONGAMENTO AXIAL mm.	DESVÍO LATERAL mm.	DESVÍO ANGULAR GRAUS	COD. EPDM	€ EPDM	COD. NBR	€ NBR
32	95	10	6	10	15	VSMB0032	35,65		
40	95	10	6	10	15	VSMB0040	35,65	VSMBN040	50,25
50	105	10	6	10	15	VSMB0050	44,65	VSMBN050	62,50
65	115	15	8	12	15	VSMB0065	55,50	VSMBN065	75,60
80	135	15	8	12	15	VSMB0080	66,00	VSMBN080	101,05
100	135	20	12	16	15	VSMB0100	79,55	VSMBN100	109,60
125	165	20	12	16	15	VSMB0125	111,55	VSMBN125	142,65
150	180	20	12	16	15	VSMB0150	148,15	VSMBN150	202,35
200	205	20	12	16	15	VSMB1200	221,90		
200	205	20	12	16	15	VSMB0200	222,40	VSMBN200	312,25
250	240	30	14	25	15	VSMB1250	314,75		
250	240	30	14	25	15	VSMB0250	337,00	VSMBN250	444,90
300	260	30	14	25	15	VSMB1300	434,50		
300	260	30	14	25	15	VSMB0300	474,10		
350	265	30	14	25	15	VSMB0350	719,70		
400	265	30	14	25	15	VSMB0400	877,95		

Flanges: ■ PN 10 ■ PN 16

CARACTERÍSTICAS TÉCNICAS

Pressão de serviço: PN 10 e PN 16.
 Vácuo : 760 mm Hg.
 Temperatura: -20° C a 115° C.
 União por flanges em aço.

COMPONENTES

Polímero base: * EPDM no interior e exterior
 * NBR interior / EPDM exterior
 Reforço de nylon com cabo de aço
 Flanges de aço carbono zincado

Relação Pressão / Temperatura

Tª (°C)	-20	20	60	80	115
P (bar)	16	16	16	16	1

JUNTA DE EXPANSÃO METÁLICA COM CAMISA INTERIOR – EXTREMOS SOLDAR

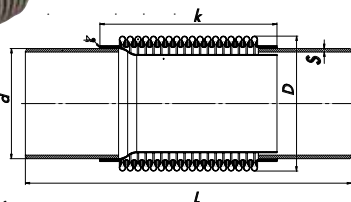
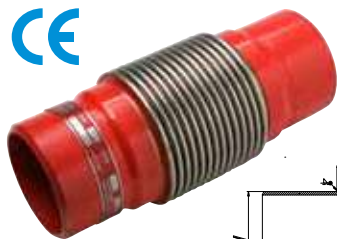

CARACTERÍSTICAS TÉCNICAS

Pressão de serviço: PN 16.
Camisa interior: AISI 321.
Mola: AISI 321
Corpo em aço.

DN	DIMENSÕES				COMPRESSÃO AXIAL	COD.	€
	Ø d mm.	Ø D mm.	ESPIRAIS	L mm.			
25	38,0	48	20	250	+5 -25	VSMUM025	72,25
32	42,4	55	28	350	+10 -30	VSMUM032	83,60
40	48,3	61	24	350	+10 -30	VSMUM040	96,75
50	60,3	76	26	350	+10 -35	VSMUM050	106,00
65	76,1	95	26	350	+10 -35	VSMUM065	130,65
80	88,9	111	18	350	+10 -40	VSMUM080	157,05
100	114,3	140	18	350	+10 -40	VSMUM100	199,75
125	139,7	164	17	350	+10 -40	VSMUM125	280,70
150	168,3	200	15	350	+10 -40	VSMUM150	360,20
200	219,1	250	14	350	+10 -40	VSMUM200	542,15

JUNTA DE EXPANSÃO METÁLICA COM CAMISA INTERIOR FLANGEADA

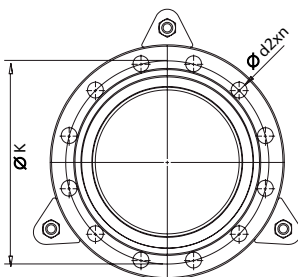
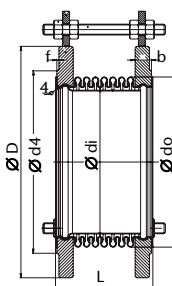

CARACTERÍSTICAS TÉCNICAS

Pressão de serviço: PN 16.
Camisa interior: AISI 321.
Mola: AISI 321.
Tirantes: Rst. 37.2.
Suporte: Rst. 37.2
Porca: Rst. 37.2
Flanges: Rst. 37.2

DN	FLANGES					MOLA				L mm.	COMPRESSÃO AXIAL	COD.	€
	Ø D mm.	Ø k mm.	Ø d4 mm.	f mm.	b mm.	Ø d2xn	Ø di mm.	Ø do mm.	ESPIRAIS				
25	115	85	68	2	16	Ø14x4	38,0	48,2	18	120	+10 -20	VSMBM025	109,65
32	140	100	78	2	16	Ø18x4	42,4	55,0	18	125	+10 -20	VSMBM032	115,15
40	150	110	88	3	16	Ø18x4	48,3	61,0	18	130	+10 -20	VSMBM040	136,60
50	165	125	102	3	18	Ø18x4	60,3	76,0	14	120	+10 -20	VSMBM050	147,95
65	185	145	122	3	18	Ø18x4	76,1	95,0	12	120	+10 -20	VSMBM065	170,75
80	200	160	138	3	20	Ø18x8	88,9	111,0	9	120	+10 -20	VSMBM080	204,85
100	220	180	158	3	20	Ø18x8	114,3	140,0	9	130	+10 -20	VSMBM100	260,65
125	250	210	188	3	22	Ø18x8	139,7	164,0	9	140	+10 -20	VSMBM125	310,55
150	285	240	212	3	22	Ø23x8	168,3	200,0	9	155	+8 -25	VSMBM150	372,45
200	340	295	268	3	24	Ø23x12	219,1	250,0	7	150	+8 -25	VSMBM200	588,90
250	405	355	320	3	26	Ø27x12	273,0	323,0	5	200	+8 -35	VSMBM250	769,15

UNIÕES DE EXPANSÃO ("TACO")

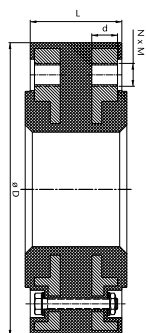

CARACTERÍSTICAS TÉCNICAS

Pressão de serviço: PN 10.
Temperatura: -10° C a 80° C.
Aperto mínimo: 30 Nm.
União por flanges vulcanizadas.

COMPONENTES

Polímero base: EPDM
Flanges em aço carbono

DN	L mm.	FLANGE PN10				COD.	€
		D mm.	ENTRE FUROS mm.	N x M	d mm.		
20	71	111	75	4 x M12	14	VSMG0020	87,95
25	71	120	85	4 x M12	16	VSMG0025	94,80
32	71	146	100	4 x M16	16	VSMG0032	106,95
40	71	157	110	4 x M16	16	VSMG0040	117,60
50	71	171	125	4 x M16	16	VSMG0050	138,95
65	71	191	145	4 x M16	16	VSMG0065	158,90
80	71	207	160	8 x M16	18	VSMG0080	182,60
100	71	226	180	8 x M16	18	VSMG0100	211,70
125	71	256	210	8 x M16	18	VSMG0125	230,15
150	71	291	240	8 x M20	18	VSMG0150	323,95
200	91	347	295	8 x M20	20	VSMG0200	419,50

770 JUNTA MULTI-MATERIAL

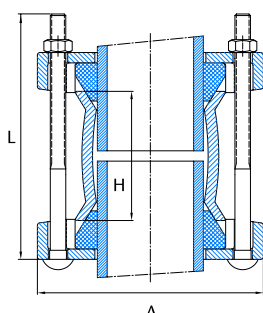

DN	TOLERÂNCIA	PARAFUSO			A mm.	H mm.	COD.	€
		Nº	MÉTRICA	L mm.				
40	48 - 60	2	M12	200	145	95	VF770040	36,00
50	59 - 72	4	M12	200	161	100	VF770050	47,50
65	68 - 85	4	M12	200	166	100	VF770065	54,45
80	88 - 103	4	M12	200	190	100	VF770080	67,70
100	99 - 119	4	M12	200	225	100	VF770101	80,65
100	109 - 128	4	M12	190	221	95	VF770100	78,90
125	132 - 157	4	M12	190	245	95	VF770125	95,90
150	159 - 182	4	M12	200	281	105	VF770150	120,00
175	192 - 210	4	M12	230	305	130	VF770175	136,50
200	218 - 235	4	M12	230	331	130	VF770200	142,70
225	242 - 268	6	M12	230	367	130	VF770225	194,45
250	272 - 289	6	M12	230	395	130	VF770250	240,40
300	315 - 332	6	M12	230	440	130	VF770300	268,55

CARACTERÍSTICAS TÉCNICAS

Para a união de tubos de fundição, PVC, aço e fibrocimento.
 Fabricado em fundição nodular GGG 40 (EN-GJS-400-15) com revestimento "EPOXY" 250 µm.
 Juntas em EPDM.
 Parafusos em aço com revestimento DACROMET.

780 UNIÃO UNIVERSAL COM FLANGES

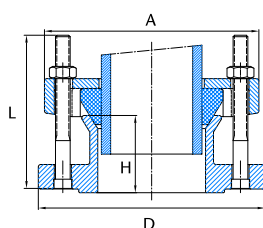

DN	TOLERÂNCIA	PARAFUSO			A mm.	D mm.	H mm.	COD.	€
		Nº	MÉTRICA	L mm.					
50	59 - 72	4	M12	130	161	164	80	VF780050	48,55
65	68 - 85	4	M12	130	166	185	82	VF780065	54,35
80	88 - 103	4	M12	130	190	204	81	VF780080	62,00
100	99 - 119	4	M12	145	225	234	100	VF780101	76,15
100	109 - 128	4	M12	130	221	215	82	VF780100	71,45
125	132 - 157	4	M12	130	245	273	82	VF780125	82,90
150	159 - 182	4	M12	130	281	299	80	VF780150	106,95
200	192 - 210	4	M12	130	305	340	80	VF780175	129,40
200	218 - 235	4	M12	130	331	340	80	VF780200	135,85
250	242 - 268	6	M12	140	367	400	90	VF780225	193,95
250	272 - 289	6	M12	140	395	400	90	VF780250	200,15
300	315 - 332	6	M12	140	440	455	92	VF780300	231,65

CARACTERÍSTICAS TÉCNICAS

Adequada para flanges PN 10 e PN 16.
 Para a união de tubos de fundição, PVC, aço e fibrocimento.
 Fabricado em fundição nodular GGG 40 (EN-GJS-400-15) com revestimento "EPOXY" 250 µm.
 Juntas em EPDM.
 Parafusos em aço com revestimento DACROMET.

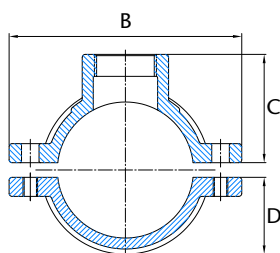
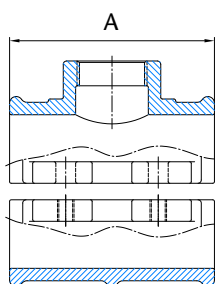

Ø EXT TUBO mm.	SAÍDA ROSCADA	A mm.	B mm.	C + D mm.	COD.	€
50	3/4"	80	115	84	VF720504	28,45
	1"	80	115	84	VF720505	28,45
63	3/4"	90	130	97	VF720634	32,30
	1"	90	130	97	VF720635	32,30
	1 1/4"	90	130	97	VF720636	33,25
	1 1/2"	90	130	97	VF720637	33,80
75	2"	90	130	97	VF720638	34,95
	3/4"	100	145	110	VF720754	36,50
	1"	100	145	110	VF720755	36,50
	1 1/4"	100	145	110	VF720756	36,80
90	1 1/2"	100	145	110	VF720757	38,05
	2"	100	145	110	VF720758	38,05
	3/4"	100	156	124	VF720904	41,70
	1"	100	156	124	VF720905	41,70
110	1 1/4"	100	156	124	VF720906	42,45
	1 1/2"	100	156	124	VF720907	42,90
	2"	100	156	124	VF720908	44,25
	3/4"	100	178	144	VF721104	49,05
125	1"	100	178	144	VF721105	49,05
	1 1/4"	100	178	144	VF721106	49,75
	1 1/2"	100	178	144	VF721107	50,05
	2"	100	178	144	VF721108	50,20
140	3/4"	110	198	160	VF721254	63,80
	1"	110	198	160	VF721255	63,80
	1 1/4"	110	198	160	VF721256	64,80
	1 1/2"	110	198	160	VF721257	65,95
	2"	110	198	160	VF721258	66,80
	2 1/2"	110	198	160	VF72125A	73,75
	3"	110	198	160	VF72125B	74,45
160	1"	110	215	176	VF721405	69,40
	1 1/4"	110	215	176	VF721406	70,50
	1 1/2"	110	215	176	VF721407	71,45
	2"	110	215	176	VF721408	71,90
	2 1/2"	110	215	176	VF72140A	82,70
	3"	110	215	176	VF72140B	83,40
200	1"	125	235	198	VF721605	83,25
	1 1/4"	125	235	198	VF721606	84,25
	1 1/2"	125	235	198	VF721607	84,50
	2"	125	235	198	VF721608	85,15
250	3"	125	235	198	VF72160B	105,70
	1"	140	290	240	VF722005	124,55
	1 1/4"	140	290	240	VF722006	125,40
	1 1/2"	140	290	240	VF722007	126,75
315	2"	140	290	240	VF722008	130,20
	3"	140	290	240	VF72200B	131,05
	1"	140	341	291	VF722505	204,30
	1 1/2"	140	341	291	VF722507	205,50
315	2"	140	341	291	VF722508	206,25
	3"	140	341	291	VF72250B	207,15
	2"	140	409	356	VF723158	253,00
	3"	140	409	356	VF72315B	253,90

CARACTERÍSTICAS

Fabricado em fundição nodular GGG 50 (EN-GJS-500-7) com revestimento "EPOXY" 250 µm. Juntas em EPDM.

Parafusos de aço inoxidável A2.

730 UNIÃO ANTI-TRAÇÃO PARA TUBO PE

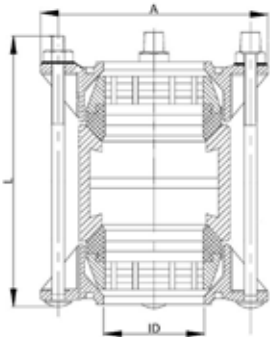

Ø mm.	PARAFUSO		A mm.	L mm.	ID mm.	COD.	€
	MÉTRICA	Nº					
63	M12	4	165	180	67	VF730063	78,85
75	M12	4	177	180	79	VF730075	112,60
90	M12	4	195	180	94	VF730090	128,35
110	M12	4	212	180	115	VF730110	157,10
125	M12	4	228	200	130	VF730125	214,95
140	M12	4	245	200	145	VF730140	240,80
160	M12	4	270	220	165	VF730160	254,15
200	M12	4	313	220	205	VF730200	339,55
250	M16	6	375	250	255	VF730250	637,80
315	M16	6	442	300	320	VF730315	977,95

CARACTERÍSTICAS TÉCNICAS

Pressão de serviço: PN 16.

Fabricado em fundição nodular GGG 50 (EN-GJS-500-7) com revestimento "EPOXY" 250 µm. Juntas em EPDM.

Anel de compressão em latão.

Parafusos em aço com revestimento DACROMET.

740 UNIÃO ANTI-TRAÇÃO FLANGEADA PARA TUBO PE

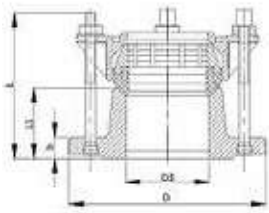

DN	Ø mm.	PARAFUSO		D3 mm.	b mm.	L1 mm.	L mm.	D mm.	COD.	€
		MÉTRICA	Nº							
50/65	63	M12	4	80	19	65	110	185	VF740063	77,20
65	75	M12	4	94	19	65	110	185	VF740075	94,95
80	90	M12	4	108	19	65	110	200	VF740090	110,05
100	110	M12	4	128	19	65	110	220	VF740110	123,20
125	125	M12	4	142	19	65	120	250	VF740125	171,00
125	140	M12	4	160	19	65	120	250	VF740140	191,05
150	160	M12	4	180	19	65	120	285	VF740160	202,65
200	200	M16	4	220	19	75	140	340	VF740200	289,50
250	250	M16	6	270	22	85	170	400	VF740250	482,55
300	315	M16	6	334	24	85	170	455	VF740315	637,00

Flanges: PN 10/16

CARACTERÍSTICAS TÉCNICAS

Pressão de serviço: PN 16.

Fabricado em fundição nodular GGG 50 (EN-GJS-500-7) com revestimento "EPOXY" 250 µm. Juntas em EPDM.

Anel de compressão em latão.

Parafusos em aço com revestimento DACROMET.

750

FLANGE DUPLA CAMERA ANTI-TRAÇÃO PARA TUBO PE

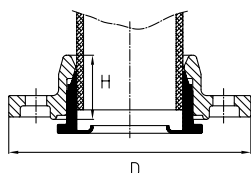

DN	Ø mm.	H mm.	D mm.	COD.	€
50 - 65	63	50	182	VF750063	37,05
65	75	55	185	VF750075	38,65
80	90	60	195	VF750090	54,10
100	110	63	216	VF750110	59,50
125	125	70	253	VF750125	72,35
125	140	78	253	VF750140	86,85
150	160	78	280	VF750160	106,20
200	200	88	336	VF750200	148,00

Flanges: PN 10/16

CARACTERÍSTICAS TÉCNICAS

Fabricadas em fundição nodular GGG 50 (EN-GLS-500-7) com revestimento "EPOXY" 250 µm.
Juntas em EPDM.
Anel de compressão em latão.

760

FLANGE DUPLA CAMERA PARA TUBO DE PVC

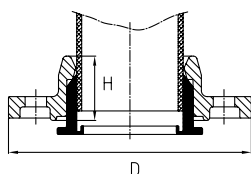

DN	Ø mm.	H mm.	D mm.	COD.	€
50 - 65	63	50	182	VF760063	27,35
65	75	55	185	VF760075	28,90
80	90	60	195	VF760090	38,65
100	110	63	216	VF760110	41,35
125	125	70	253	VF760125	52,90
125	140	78	253	VF760140	54,75
150	160	78	280	VF760160	67,55
200	200	88	336	VF760200	102,95

Flanges: PN 10/16

CARACTERÍSTICAS TÉCNICAS

Fabricadas em fundição nodular GGG 50 (EN-GLS-500-7) com revestimento "EPOXY" 250 µm.
Juntas em EPDM.

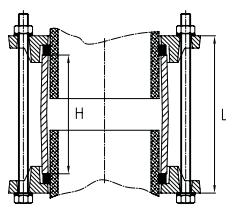
710/D UNIÃO GIBALT PARA TUBO DE PVC

Ø mm.	PARAFUSO		H mm.	L mm.	COD.	€
	MÉTRICA	Nº				
63	M12	2	125	164	VF71D063	26,50
75	M12	2	125	164	VF71D075	32,90
90	M12	3	125	164	VF71D090	39,40
110	M12	3	145	184	VF71D110	48,20
125	M12	3	145	184	VF71D125	57,90
140	M12	4	145	184	VF71D140	76,00
160	M12	4	180	219	VF71D160	94,05
180	M12	4	180	219	VF71D180	105,40
200	M12	6	180	219	VF71D200	121,80
250	M12	6	180	220	VF71D250	180,50
315	M12	6	180	220	VF71D315	222,85

CARACTERÍSTICAS TÉCNICAS

Fabricado em fundição nodular GGG 50 (EN-GJS-500-7) com revestimento de "EPOXY" 250um.
Junta em EPDM.
Parafusos em aço zincado.

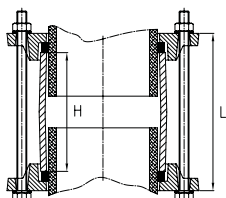
710 UNIÃO GIBALT PARA TUBO DE PVC

Ø mm.	PARAFUSO		H mm.	L mm.	COD.	€
	MÉTRICA	Nº				
50	M10	2	70	96	VF710050	10,95
63	M10	2	100	139	VF710063	13,50
75	M10	2	100	135	VF710075	16,05
90	M10	2	110	140	VF710090	18,05
110	M10	3	120	150	VF710110	27,35
125	M12	3	120	157	VF710125	31,15
140	M12	3	120	157	VF710140	34,10
160	M12	3	140	176	VF710160	41,15
180	M12	3	140	181	VF710180	58,90
200	M12	3	140	176	VF710200	67,85
250	M14	4	160	204	VF710250	102,95
315	M14	4	160	204	VF710315	138,35
400	M14	6	160	208	VF710400	176,95
500	M14	6	160	216	VF710500	241,35

CARACTERÍSTICAS TÉCNICAS

Fabricado em fundição gris GG 25 (EN-GJL-250) revestidas com pintura negra.
Junta em EPDM.
Parafusos em aço zincado.

790

COLARINHO COM TOMADA PARA TUBO DE PVC



CARACTERÍSTICAS TÉCNICAS

Fabricado em fundição gris GG 25
(EN-GJL-250) revestidas com pintura negra.
Junta em EPDM.
Parafusos em aço zincado.

DN	Ø	COD.	€
40	3/4"	VF790404	6,95
	1"	VF790405	6,95
50	3/4"	VF790504	8,55
	1"	VF790505	8,55
63	3/4"	VF790634	10,20
	1"	VF790635	10,20
	1 1/4"	VF790636	10,20
75	3/4"	VF790754	10,10
	1"	VF790755	10,10
	1 1/4"	VF790756	10,10
90	3/4"	VF790904	12,10
	1"	VF790905	12,40
	1 1/4"	VF790906	12,40
	1 1/2"	VF790907	18,35
	2"	VF790908	19,00
110	3/4"	VF791104	16,90
	1"	VF791105	16,90
	1 1/4"	VF791106	16,90
	1 1/2"	VF791107	20,15
	2"	VF791108	20,40
	2 1/2"	VF79110A	24,80
125	3/4"	VF791254	20,80
	1"	VF791255	20,80
	1 1/4"	VF791256	21,60
	1 1/2"	VF791257	23,25
	2"	VF791258	23,45

DN	Ø	COD.	€
125	2 1/2"	VF79125A	28,80
	3"	VF79125B	29,20
140	1"	VF791405	23,00
	1 1/4"	VF791406	23,65
	1 1/2"	VF791407	24,50
	2"	VF791408	25,75
	2 1/2"	VF79140A	29,75
	3"	VF79140B	30,75
160	1"	VF791605	27,10
	1 1/4"	VF791606	28,25
	1 1/2"	VF791607	28,85
	2"	VF791608	29,55
	2 1/2"	VF79160A	31,95
	3"	VF79160B	32,45
200	1"	VF792005	35,60
	1 1/4"	VF792006	36,05
	1 1/2"	VF792007	36,40
	2"	VF792008	37,45
	2 1/2"	VF79200A	42,60
	3"	VF79200B	42,90
250	2"	VF792508	56,85
	2 1/2"	VF79250A	57,45
	3"	VF79250B	58,10
315	2"	VF793158	67,55
	2 1/2"	VF79315A	68,20
	3"	VF79315B	68,95

790/I

COLARINHO COM TOMADA PARA TUBO DE PVC COM PARAFUSOS INOX



CARACTERÍSTICAS TÉCNICAS

Fabricado em fundição gris GG 25
(EN-GJL-250) revestidas com pintura negra.
Junta em EPDM
Parafusos em aço inoxidável A2.

DN	Ø	COD.	€
50	3/4"	VF7I0504	9,55
	1"	VF7I0505	9,55
63	3/4"	VF7I0634	12,20
	1"	VF7I0635	12,20
75	3/4"	VF7I0754	11,85
	1"	VF7I0755	11,85
90	3/4"	VF7I0904	13,80
	1"	VF7I0905	14,15
110	3/4"	VF7I1104	19,05
	1"	VF7I1105	19,05
125	3/4"	VF7I1254	22,00
	1"	VF7I1255	22,00
140	1"	VF7I1405	23,45
160	1"	VF7I1605	26,70

ABRAÇADEIRAS DE REPARAÇÃO
UMA BANDA (UM FECHO)

Comprimento 200mm, 2 pernos M14



COMPRIMENTO mm.	TOLERÂNCIA mm.	PRESSÃO MÁX bar	COD.	€
200	48-55	16	VF812048	80,00
200	52-59	16	VF812052	81,35
200	60-67	16	VF812060	84,45
200	67-74	16	VF812067	87,40
200	73-80	16	VF812073	92,60
200	82-90	16	VF812082	95,40
200	87-95	16	VF812087	98,75
200	95-105	16	VF812095	101,45
200	108-118	16	VF812108	107,20
200	118-128	16	VF812118	112,45
200	135-145	16	VF812135	118,80
200	145-155	16	VF812145	125,20
200	151-161	16	VF812151	131,05
200	165-175	16	VF812165	134,70
200	176-186	16	VF812176	142,00
200	193-203	16	VF812193	149,90
200	200-212	10	VF812200	155,55
200	219-229	10	VF812219	162,10

Reparação de tubos de aço, fundição, fibrocimento, PE e PVC (apenas água).

Fabricados totalmente em aço inoxidável AISI 304.

Junta de EPDM em forma de quadrícula.

Temperatura máxima de utilização: 120° C.

DUAS BANDAS (DOIS FECHOS)

Comprimento 300mm, 3 pernos M 16

Comprimento 400mm, 4 pernos M 16



COMPRIMENTO mm.	TOLERÂNCIA mm.	PRESSÃO MÁX bar	COD.	€
300	108-128	16	VF823108	217,90
300	135-155	16	VF823135	229,10
300	159-180	16	VF823159	238,80
300	190-210	16	VF823190	290,20
300	210-230	10	VF823210	305,25
300	225-246	10	VF823225	312,85
300	240-260	10	VF823240	324,85
300	269-289	10	VF823269	380,25
300	282-302	10	VF823282	433,90
300	295-315	10	VF823295	445,10
400	322-344	6	VF824322	593,80
400	347-367	6	VF824347	618,00
400	365-385	6	VF824365	643,45
400	395-415	6	VF824395	678,35
400	420-440	6	VF824420	704,60



507 VOLANTE para Ref. 500

DN	COD.	€
40 - 50 - 65	VF507050	15,00
80	VF507080	20,00
100	VF507100	20,00
125 - 150	VF507125	27,65
200	VF507200	27,65
250 - 300	VF507250	37,55
350 - 400	VF507350	63,45
500	VF507500	166,00



515 REDE para Ref. 510

DN	COD.	€
40	VF515040	12,20
50	VF515050	15,30
65	VF515065	23,00
80	VF515080	24,55
100	VF515100	34,70
125	VF515125	50,00
150	VF515150	71,95
200	VF515200	123,65
250	VF515250	174,00
300	VF515300	203,95
350	VF515350	349,00
400	VF515400	432,05



516 JUNTA para Ref. 510

DN	COD.	€
40	VF516040	2,65
50	VF516050	3,50
65	VF516065	3,50
80	VF516080	3,50
100	VF516100	5,30
125	VF516125	5,30
150	VF516150	5,35
200	VF516200	14,10
250	VF516250	16,35
300	VF516300	19,80
350	VF516350	23,65
400	VF516400	26,05



517 TAMPÃO para Ref. 510

DN	COD.	€
40 - 50 - 65 80 - 100 125 - 150	VF517040	3,15
200 - 250 - 300	VF517200	4,75
350 - 400 - 500	VF517350	9,25



506 COMPORTA para Ref. 500

DN	COD.	€
40	VF506040	8,65
50	VF506050	11,45
65	VF506065	15,05
80	VF506080	21,60
100	VF506100	31,15
125	VF506125	38,05
150	VF506150	52,35
200	VF506200	98,35
250	VF506250	149,10
300	VF506300	193,50
350	VF506350	365,00
400	VF506400	450,00
500	VF506500	824,85



558 BOLA para Ref. 550 e 555

DN	COD.	€
1" - 1 1/4"	VF558006	18,55
1 1/2" - 40	VF558007	29,65
2" - 50	VF558050	37,35
2 1/2" - 65	VF558065	44,85
3" - 80	VF558080	59,00
100	VF558100	80,85
125	VF558125	132,95
150	VF558150	160,65
200	VF558200	336,80
250	VF558250	400,55
300	VF558300	715,85



559 JUNTA para Ref. 550 e 555

DN	COD.	€
1" - 1 1/4"	VF559006	1,10
1 1/2"	VF559007	1,40
2"	VF559008	1,55
2 1/2"	VF55900A	1,55
3"	VF55900B	2,25
40	VF559040	1,10
50	VF559050	1,55
65	VF559065	1,55
80	VF559080	2,25
100	VF559100	2,65
125	VF559125	4,45
150	VF559150	8,20
200	VF559200	8,20
250	VF559250	9,65
300	VF559300	11,00

990 V. REDUTOR para Ref. 901, 911, 931, 951, 961 e 971



DN	COD.	€
40 - 50 - 65	VF990050	57,35
80 - 100	VF990080	57,35
125 - 150	VF990125	57,35
200	VF990200	103,95
250	VF990250	103,95
300	VF990300	111,70
350	VF990350	132,95
400	VF990400	349,00
500	VF990500	465,30

991 MANÍPULO para Ref. 900, 910, 930, 950, 960 e 970



DN	COD.	€
40 - 50 - 65	VF991050	11,10
80 - 100	VF991080	11,10
125 - 150	VF991125	17,95
200	VF991200	31,00
250 - 300	VF991250	41,55



571 MANÍPULO para Ref. 570

DN	COD.	€
15-20	VF57P015	1,85
25-32	VF57P025	3,80
40	VF57P040	6,05
50	VF57P050	7,50
65-80	VF57P065	9,40
100	VF57P100	11,05
125-150	VF57P125	29,70
200	VF57P200	47,20



719 JUNTA para União GIBALTT

DN	COD.	€
50	VF71J050	0,60
63	VF71J063	0,75
75	VF71J075	0,85
90	VF71J090	0,90
110	VF71J110	1,30
125	VF71J125	1,65
140	VF71J140	1,75
160	VF71J160	1,85
180	VF71J180	3,70
200	VF71J200	4,60
250	VF71J250	6,50
315	VF71J315	7,20
400	VF71J400	9,45
500	VF71J500	17,95

VÁLVULAS COM **ATUADOR**

A automatização de válvulas de fundição (tipo borboleta) e válvulas de bola (aço inoxidável) supõe um novo passo orientado a satisfazer as necessidades do mercado no setor da automatização.

Nesta área apresentamos uma ampla gama de atuadores pneumáticos com rotação de um quarto de volta nas suas versões de simples e duplo efeito, assim como atuadores elétricos multivoltagem, todas esta gama acompanhada dos correspondentes complementos (fins de curso, electroválvulas, posicionadores) para serem utilizados dentro de condições específicas em aplicações para a condução de fluídos.



VÁLVULAS COM
ATUADOR

AUTOMATIZAÇÃO DE VÁLVULAS

Dado que muitas das atuais aplicações tem como base um alto grau de automatização e controlo, apresentamos a automatização de válvulas de fundição (borboleta) e Inox (bola) com atuadores rotativos pneumáticos e elétricos, os atuadores devem posicionar as válvulas de acordo com as ordens de manobra para a qual a válvula é pretendida, uma vez na posição desejada, estes desativam-se e podem sinalizar o seu estado a um quadro de comando através dos sensores instalados.

ATUADORES PNEUMÁTICOS ROTATIVOS DE SIMPLES (SE) OU DUPLO (DE) EFEITO.

Transformam a energia do ar comprimido em energia mecânica de rotação limitada a um ¼ de volta (0°- 90°) através de sistema cremalheira-pinhão.

Características principais:

Fornecimento torque (ar 6 bares) desde 12 a 3120 Nm, extensível até 10857 Nm.

Desenhados para permitir a mudança de configuração de SE a DE e vice-versa.

Ajuste do curso do ângulo dos pistões (+-5°) na abertura e fecho.

Proteção anti corrosão com anodizado puro sobre caixa de alumínio extrudido.

Proteção IP67.

Eixo não injetado.

Pistões em alumínio injetado anodizado e mecanizado para uma maior duração do atuador.

Tampas em alumínio injetado com proteção em epoxy.

Pinhão em aço carbono niquelado.

Parafusos em aço inox AISI 304.

Placa ISO 5211 / DIN 3337.

Montagem direta com electroválvula NAMUR e montagem com acessórios NAMUR VDI/VDE 3845.

CERTIFICAÇÃO ATEX segundo Diretiva 2014/35/EU.

Configuração fornecida de série:

Simple efeito: o atuador é fornecido para rotação no sentido horário no modo sem pressão de ar, isto significa, que a válvula manter-se-á na posição fechada (NC)

- É necessário termos pressão de ar para abrir (comprimir as molas, rotação anti horário).
- Sem pressão de ar, o atuador retorna à posição inicial (NC, válvula fechada) devido a descompressão das molas.

Duplo efeito: o atuador é fornecido para rotação em sentido anti-horário quando se aplica pressão (é necessário pressão quer para abrir quer para fechar) mediante pedido pode-se inverter o sentido de movimento dos pistões.



ATUADORES ELÉTRICOS

Transformam a energia elétrica em energia mecânica de rotação reversível limitada a ¼ de volta (0° - 90°) mediante um motor brushless e um redutor que transmite o torque necessário dispondo de série o acionamento manual de emergência através de volante incorporado. O atuador além de inúmeras funções de série incorpora sempre dois fim de curso para a sinalização da manobra. Como opção permite comunicar com o exterior (protocolo MODBUS ou via BLUETOOTH, Wi-Fi).

Características principais:

Torque fornecido desde 20 até 350Nm.

Ligador para alimentação multivoltagem e para contactos auxiliares.

Regulação do funcionamento automático ou manual com comando manual de emergência.

Indicadores visuais de manobra e de posição.

Limitador elétrico do torque.

Controlo automático de temperatura interna.

Interruptores de fim de curso (micros stop motor e confirmação).

Proteção IP67 s/IEC 60529.

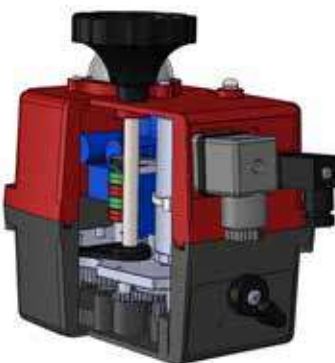

CONDIÇÕES DE FUNCIONAMENTO (ATUADORES PNEUMÁTICOS E ELÉTRICOS)

O torque de arranque e de manobra conforme condições de operação podem variar dependendo das condições do fluido. Para evitar erros de operação no acionamento da válvula devem ser respeitadas as seguintes condições:

Atuadores pneumáticos.

- Alimentação com ar comprimido filtrado, seco ou lubrificado.
- Pressão de ar: mínimo 6 bar.
- Temperatura de trabalho: -20° C a + 80° C, para outras temperaturas consultar.

Atuadores elétricos.

- Baixa voltagem (tipo B), 12 VDC/VAC 50/60 Hz -0/+5%.
- Alta voltagem (tipo S), 24 a 240VAC 50/60 Hz e 24-125VDC -0/+5%.
- Temperatura de trabalho: -20° C a + 70° C.
- Tempo de manobra sem carga: 10 a 48 segundos (90° C), para tempos de manobra especiais consultar.
- Tempo sobre tensão: 75%.

Para outras voltagens por favor consultar.

Atuadores pneumáticos e elétricos.

Tipo de fluido a transportar (*):

- Fluidos líquidos, limpos não incrustantes nem agressivos isentos de contaminantes que possam modificar a fricção (por ressecarem ou outras causas) do sistema de abertura e fecho da válvula.
- Velocidade de fluido estável.
- O ciclo de operação mensal como mínimo definido.

(*) para qualquer outro tipo de fluido, seja líquido ou gasoso, deve realizar-se uma consulta prévia antes do pedido.

DISPOSITIVOS OPCIONAIS (ATUADORES PNEUMÁTICOS E ELÉTRICOS)

Nos COMPLEMENTOS encontram-se os dispositivos normais disponíveis. Para outros tipos não especificados por favor consulte.

A 900

VÁLVULA COM ATUADOR DE BORBOLETA TIPO WAFER

VÁLVULA

Corpo: Fundição Nodular GGG40 (EN-GLS-400-15)

Disco: Aço Inoxidável AISI 316 (CF8M)

Elastômetro: EPDM

Pressão de serviço: PN 16

Temperatura: -10° C a 120° C

Adequada para flanges PN10 e PN16

ATUADOR PNEUMÁTICO

Cálculo base com pressão a 6 bar (intervalo de trabalho 2 a 8 bar)

Temperatura: -20° C a 80° C

ATUADOR ELÉTRICO

Motor multivoltagem

Temperatura -20° C a 70° C.

ATUADOR PNEUMÁTICO

SIMPLES EFEITO			DUPLO EFEITO		
DN	COD.	€	DN	COD.	€
32	AS900032	203,05	32	AD900032	187,05
40	AS900040	203,05	40	AD900040	187,05
50	AS900050	236,15	50	AD900050	187,45
65	AS900065	279,80	65	AD900065	195,20
80	AS900080	336,70	80	AD900080	244,55
100	AS900100	396,25	100	AD900100	293,55
125	AS900125	472,05	125	AD900125	339,40
150	AS900150	640,10	150	AD900150	398,90
200	AS900200	981,30	200	AD900200	526,75
250	AS900250	1.409,75	250	AD900250	765,85
300	AS900300	2.374,05	300	AD900300	1.182,60
350	AS900350	4.109,85	350	AD900350	1.636,25
400	AS900400	5.950,10	400	AD900400	2.794,80
500	AS900500	9.198,15	500	AD900500	4.173,10

ATUADOR ELÉTRICO

BAIXA VOLTAGEM			ALTA VOLTAGEM		
DN	COD.	€	DN	COD.	€
32	AB900032	421,40	32	AA900032	421,40
40	AB900040	421,40	40	AA900040	421,40
50	AB900050	421,85	50	AA900050	421,85
65	AB900065	573,00	65	AA900065	573,00
80	AB900080	667,75	80	AA900080	667,75
100	AB900100	831,10	100	AA900100	831,10
125	AB900125	848,05	125	AA900125	848,05
150	AB900150	1.094,75	150	AA900150	1.094,75
200	AB900200	1.288,45	200	AA900200	1.288,45
250	AB900250	1.405,95	250	AA900250	1.405,95

A 910 VÁLVULA COM ATUADOR DE BORBOLETA TIPO WAFER

VÁLVULA

Corpo: Fundição Nodular GGG40 (EN-GLS-400-15)

Disco: Fundição Nodular GGG40 (EN-GLS-400-15) Zincada

Elastômetro: EPDM

Pressão de serviço: PN 16

Temperatura: -10° C a 120° C

Adequada para flanges PN10 e PN16

ATUADOR PNEUMÁTICO

Cálculo base com pressão a 6 bar (intervalo de trabalho 2 a 8 bar)

Temperatura: -20° C a 80° C

ATUADOR ELÉTRICO

Motor multivoltagem

Temperatura -20° C a 70° C.



ATUADOR PNEUMÁTICO					
SIMPLES EFEITO			DUPLO EFEITO		
DN	COD.	€	DN	COD.	€
32	AS910032	198,00	32	AD910032	182,00
40	AS910040	198,00	40	AD910040	182,00
50	AS910050	231,10	50	AD910050	182,30
65	AS910065	272,90	65	AD910065	188,30
80	AS910080	327,40	80	AD910080	235,20
100	AS910100	380,45	100	AD910100	277,75
125	AS910125	445,00	125	AD910125	312,35
150	AS910150	603,25	150	AD910150	362,10
200	AS910200	902,80	200	AD910200	448,20
250	AS910250	1.253,15	250	AD910250	609,25
300	AS910300	2.111,35	300	AD910300	919,95
350	AS910350	3.755,25	350	AD910350	1.281,70
400	AS910400	5.419,45	400	AD910400	2.264,15
500	AS910500	8.181,20	500	AD910500	3.156,15

ATUADOR ELÉTRICO					
BAIXA VOLTAGEM			ALTA VOLTAGEM		
DN	COD.	€	DN	COD.	€
32	AB910032	416,35	32	AA910032	416,35
40	AB910040	416,35	40	AA910040	416,35
50	AB910050	416,70	50	AA910050	416,70
65	AB910065	566,10	65	AA910065	566,10
80	AB910080	658,45	80	AA910080	658,45
100	AB910100	815,30	100	AA910100	815,30
125	AB910125	820,95	125	AA910125	820,95
150	AB910150	1.057,95	150	AA910150	1.057,95
200	AB910200	1.209,95	200	AA910200	1.209,95
250	AB910250	1.249,25	250	AA910250	1.249,25

A 930

VÁLVULA COM ATUADOR DE BORBOLETA TIPO WAFER

VÁLVULA

Corpo: Fundição Nodular GGG40 (EN-GLS-400-15)

Disco: Aço Inoxidável AISI 316 (CF8M)

Elastômetro: NBR

Pressão de serviço: PN 16

Temperatura: -10° C a 80° C

Adequada para flanges PN10 e PN16

ATUADOR PNEUMÁTICO

Cálculo base com pressão a 6 bar (intervalo de trabalho 2 a 8 bar)

Temperatura: -20° C a 80° C

ATUADOR ELÉTRICO

Motor multivoltagem

Temperatura -20° C a 70° C.



ATUADOR PNEUMÁTICO					
SIMPLES EFEITO			DUPLO EFEITO		
DN	COD.	€	DN	COD.	€
32	AS930032	203,05	32	AD930032	187,05
40	AS930040	203,05	40	AD930040	187,05
50	AS930050	236,15	50	AD930050	187,45
65	AS930065	279,80	65	AD930065	195,20
80	AS930080	336,70	80	AD930080	244,55
100	AS930100	396,25	100	AD930100	293,55
125	AS930125	472,05	125	AD930125	339,40
150	AS930150	640,10	150	AD930150	398,90
200	AS930200	981,30	200	AD930200	526,75
250	AS930250	1.409,75	250	AD930250	765,85
300	AS930300	2.374,05	300	AD930300	1.182,60



ATUADOR ELÉTRICO					
BAIXA VOLTAGEM			ALTA VOLTAGEM		
DN	COD.	€	DN	COD.	€
32	AB930032	421,40	32	AA930032	421,40
40	AB930040	421,40	40	AA930040	421,40
50	AB930050	421,85	50	AA930050	421,85
65	AB930065	573,00	65	AA930065	573,00
80	AB930080	667,75	80	AA930080	667,75
100	AB930100	831,10	100	AA930100	831,10
125	AB930125	848,05	125	AA930125	848,05
150	AB930150	1.094,75	150	AA930150	1.094,75
200	AB930200	1.288,45	200	AA930200	1.288,45
250	AB930250	1.405,95	250	AA930250	1.405,95

A 950 VÁLVULA COM ATUADOR DE BORBOLETA TIPO LUG

VÁLVULA

Corpo: Fundição Nodular GGG40 (EN-GJS-400-15)

Disco: Aço Inoxidável AISI 316 (CF8M)

Elastômetro: EPDM

Pressão de serviço: PN 16

Temperatura: -10° C a 120° C

ATUADOR PNEUMÁTICO

Cálculo base com pressão a 6 bar (intervalo de trabalho 2 a 8 bar)

Temperatura: -20° C a 80° C

ATUADOR ELÉTRICO

Motor multivoltagem

Temperatura -20° C a 70° C.



ATUADOR PNEUMÁTICO					
SIMPLES EFEITO			DUPLO EFEITO		
DN	COD.	€	DN	COD.	€
32	AS950032	215,80	32	AD950032	199,80
40	AS950040	215,80	40	AD950040	199,80
50	AS950050	249,65	50	AD950050	200,85
65	AS950065	293,90	65	AD950065	209,30
80	AS950080	354,50	80	AD950080	262,35
100	AS950100	427,70	100	AD950100	325,05
125	AS950125	510,95	125	AD950125	378,30
150	AS950150	693,45	150	AD950150	452,25
200	AS950201	1.060,05	200	AD950201	605,45
200	AS950200	1.060,05	200	AD950200	605,45
250	AS950251	1.505,05	250	AD950251	861,15
250	AS950250	1.505,05	250	AD950250	861,15
300	AS950301	2.529,75	300	AD950301	1.338,35
300	AS950300	2.529,75	300	AD950300	1.338,35

Flanges: ■ PN 10 ■ PN 10/16 ■ PN 16

ATUADOR ELÉTRICO					
BAIXA VOLTAGEM			ALTA VOLTAGEM		
DN	COD.	€	DN	COD.	€
32	AB950032	434,20	32	AA950032	434,20
40	AB950040	434,20	40	AA950040	434,20
50	AB950050	435,25	50	AA950050	435,25
65	AB950065	587,10	65	AA950065	587,10
80	AB950080	685,55	80	AA950080	685,55
100	AB950100	862,60	100	AA950100	862,60
125	AB950125	886,95	125	AA950125	886,95
150	AB950150	1.148,10	150	AA950150	1.148,10
200	AB950201	1.367,20	200	AA950201	1.367,20
200	AB950200	1.367,20	200	AA950200	1.367,20
250	AB950251	1.501,25	250	AA950251	1.501,25
250	AB950250	1.501,25	250	AA950250	1.501,25

Flanges: ■ PN 10 ■ PN 10/16 ■ PN 16

A 960

VÁLVULA COM ATUADOR DE BORBOLETA TIPO LUG
VÁLVULA

Corpo: Fundição Nodular GGG40 (EN-GJS-400-15)
Disco: Fundição Nodular GGG40 (EN-GLS-400-15) Zincada
Elastômetro: EPDM
Pressão de serviço: PN 16
Temperatura: -10° C a 120° C

ATUADOR PNEUMÁTICO

Cálculo base com pressão a 6 bar (intervalo de trabalho 2 a 8 bar)
 Temperatura: -20° C a 80° C

ATUADOR ELÉTRICO

Motor multivoltagem
 Temperatura -20° C a 70° C.



ATUADOR PNEUMÁTICO					
SIMPLES EFEITO			DUPLO EFEITO		
DN	COD.	€	DN	COD.	€
32	AS960032	209,50	32	AD960032	193,50
40	AS960040	209,50	40	AD960040	193,50
50	AS960050	242,20	50	AD960050	193,50
65	AS960065	286,50	65	AD960065	201,95
80	AS960080	344,45	80	AD960080	252,30
100	AS960100	410,75	100	AD960100	308,10
125	AS960125	480,35	125	AD960125	347,70
150	AS960150	643,45	150	AD960150	402,25
200	AS960201	970,70	200	AD960201	516,15
200	AS960200	970,70	200	AD960200	516,15
250	AS960251	1.357,05	250	AD960251	713,15
250	AS960250	1.357,05	250	AD960250	713,15
300	AS960301	2.266,10	300	AD960301	1.074,75
300	AS960300	2.266,10	300	AD960300	1.074,75

Flanges: ■ PN 10 ■ PN 10/16 ■ PN 16



ATUADOR ELÉTRICO					
BAIXA VOLTAGEM			ALTA VOLTAGEM		
DN	COD.	€	DN	COD.	€
32	AB960032	427,85	32	AA960032	427,85
40	AB960040	427,85	40	AA960040	427,85
50	AB960050	427,85	50	AA960050	427,85
65	AB960065	579,75	65	AA960065	579,75
80	AB960080	675,55	80	AA960080	675,55
100	AB960100	845,60	100	AA960100	845,60
125	AB960125	856,35	125	AA960125	856,35
150	AB960150	1.098,15	150	AA960150	1.098,15
200	AB960201	1.277,85	200	AA960201	1.277,85
200	AB960200	1.277,85	200	AA960200	1.277,85
250	AB960251	1.353,25	250	AA960251	1.353,25
250	AB960250	1.353,25	250	AA960250	1.353,25

Flanges: ■ PN 10 ■ PN 10/16 ■ PN 16

A 970 VÁLVULA COM ATUADOR DE BORBOLETA TIPO LUG

VÁLVULA

Corpo: Fundição Nodular GGG40 (EN-GJS-400-15)

Disco: Aço Inoxidável AISI 316 (CF8M)

Elastômetro: NBR

Pressão de serviço: PN 16

Temperatura: -10° C a 80° C

ATUADOR PNEUMÁTICO

Cálculo base com pressão a 6 bar (intervalo de trabalho 2 a 8 bar)

Temperatura: -20° C a 80° C

ATUADOR ELÉTRICO

Motor multivoltagem

Temperatura -20° C a 70° C.



ATUADOR PNEUMÁTICO					
SIMPLES EFEITO			DUPLO EFEITO		
DN	COD.	€	DN	COD.	€
32	AS970032	215,80	32	AD970032	199,80
40	AS970040	215,80	40	AD970040	199,80
50	AS970050	249,65	50	AD970050	200,85
65	AS970065	293,90	65	AD970065	209,30
80	AS970080	354,50	80	AD970080	262,35
100	AS970100	427,70	100	AD970100	325,05
125	AS970125	510,95	125	AD970125	378,30
150	AS970150	693,45	150	AD970150	452,25
200	AS970201	1.060,05	200	AD970201	605,45
200	AS970200	1.060,05	200	AD970200	605,45
250	AS970251	1.505,05	250	AD970251	861,15
250	AS970250	1.505,05	250	AD970250	861,15
300	AS970301	2.529,75	300	AD970301	1.338,35
300	AS970300	2.529,75	300	AD970300	1.338,35

Flanges: ■ PN 10 ■ PN 10/16 ■ PN 16



ATUADOR ELÉTRICO					
BAIXA VOLTAGEM			ALTA VOLTAGEM		
DN	COD.	€	DN	COD.	€
32	AB970032	434,20	32	AA970032	434,20
40	AB970040	434,20	40	AA970040	434,20
50	AB970050	435,25	50	AA970050	435,25
65	AB970065	587,10	65	AA970065	587,10
80	AB970080	685,55	80	AA970080	685,55
100	AB970100	862,60	100	AA970100	862,60
125	AB970125	886,95	125	AA970125	886,95
150	AB970150	1.148,10	150	AA970150	1.148,10
200	AB970201	1.367,20	200	AA970201	1.367,20
200	AB970200	1.367,20	200	AA970200	1.367,20
250	AB970251	1.501,25	250	AA970251	1.501,25
250	AB970250	1.501,25	250	AA970250	1.501,25

Flanges: ■ PN 10 ■ PN 10/16 ■ PN 16



A 570 VÁLVULA DE ESFERA COM ATUADOR FLANGEADA

VÁLVULA

Corpo: Fundição Gris GG 25 (EN-GJL-250)

Bola: Aço Inoxidável AISI 304

Assento: PTFE

Eixo: Aço Inoxidável AISI 304

Pressão de serviço: PN 16

Temperatura: 0° C a 150° C

ATUADOR PNEUMÁTICO

Cálculo base com pressão a 6 bar (intervalo de trabalho 2 a 8 bar)

Temperatura: -20° C a 80° C

ATUADOR ELÉTRICO

Motor multivoltagem

Temperatura -20° C a 70° C.



ATUADOR PNEUMÁTICO					
SIMPLES EFEITO			DUPLO EFEITO		
DN	COD.	€	DN	COD.	€
15	AS570015	285,40	15	AD570015	240,90
20	AS570020	291,70	20	AD570020	247,15
25	AS570025	370,95	25	AD570025	286,30
32	AS570032	424,80	32	AD570032	328,60
40	AS570040	437,95	40	AD570040	341,75
50	AS570050	497,55	50	AD570050	379,75
65	AS570065	707,50	65	AD570065	487,70
80	AS570080	760,80	80	AD570080	540,95
100	AS570100	1.114,95	100	AD570100	688,60
125	AS570125	1.620,85	125	AD570125	1.038,80
150	AS570150	2.420,80	150	AD570150	1.427,35
200	AS570200	4.269,95	200	AD570200	2.146,80

 Flanges: ■ PN 10/16 ■ PN 16

ATUADOR ELÉTRICO					
BAIXA VOLTAGEM			ALTA VOLTAGEM		
DN	COD.	€	DN	COD.	€
15	AB570015	441,20	15	AA570015	441,20
20	AB570020	447,50	20	AA570020	447,50
25	AB570025	584,15	25	AA570025	584,15
32	AB570032	664,40	32	AA570032	664,40
40	AB570040	677,55	40	AA570040	677,55
50	AB570050	823,05	50	AA570050	823,05
65	AB570065	1.086,45	65	AA570065	1.086,45
80	AB570080	1.139,75	80	AA570080	1.139,75
100	AB570100	1.348,65	100	AA570100	1.348,65
125	AB570125	1.594,65	125	AA570125	1.594,65

 Flanges: ■ PN 10/16



A 90E/A 91E /A 92E

VÁLVULAS INOX COM ATUADOR
MANIP. BORBOLETA - ALIMENTÁRIO

VÁLVULA

Corpo e Disco: Aço Inoxidável AISI 304

Elastômero: EPDM

Rosca: DIN 11851

Pressão de serviço: PN10

Temperatura: -20°C a 130°C

ATUADOR PNEUMÁTICO

Cálculo base com pressão a 6 bar (intervalo de trabalho 2 a 8 bar)

Temperatura: -20° C a 80° C

ATUADOR ELÉTRICO

Motor multivoltagem

Temperatura -20° C a 70° C.



A 90E - ROSCAR / ROSCAR

ATUADOR PNEUMÁTICO					
SIMPLES EFEITO			DUPLO EFEITO		
DN	COD.	€	DN	COD.	€
25	AS90E025	328,60	25	AD90E025	309,85
32	AS90E032	334,05	32	AD90E032	315,30
40	AS90E040	377,45	40	AD90E040	320,75
50	AS90E050	387,65	50	AD90E050	330,95
65	AS90E065	417,85	65	AD90E065	361,15
80	AS90E080	492,10	80	AD90E080	427,05
100	AS90E100	565,25	100	AD90E100	457,40

ATUADOR ELÉTRICO					
SIMPLES EFEITO			DUPLO EFEITO		
DN	COD.	€	DN	COD.	€
25	AB90E025	564,80	25	AA90E025	564,80
32	AB90E032	570,25	32	AA90E032	570,25
40	AB90E040	575,70	40	AA90E040	575,70
50	AB90E050	585,95	50	AA90E050	585,95
65	AB90E065	616,10	65	AA90E065	616,10
80	AB90E080	806,15	80	AA90E080	806,15
100	AB90E100	836,50	100	AA90E100	836,50



A 91E - ROSCAR / SOLDAR

ATUADOR PNEUMÁTICO					
SIMPLES EFEITO			DUPLO EFEITO		
DN	COD.	€	DN	COD.	€
25	AS91E025	324,60	25	AD91E025	305,85
32	AS91E032	328,60	32	AD91E032	309,85
40	AS91E040	372,00	40	AD91E040	315,30
50	AS91E050	380,90	50	AD91E050	324,25
65	AS91E065	406,90	65	AD91E065	350,25
80	AS91E080	478,25	80	AD91E080	413,25
100	AS91E100	550,30	100	AD91E100	442,50

ATUADOR ELÉTRICO					
SIMPLES EFEITO			DUPLO EFEITO		
DN	COD.	€	DN	COD.	€
25	AB91E025	560,80	25	AA91E025	560,80
32	AB91E032	564,80	32	AA91E032	564,80
40	AB91E040	570,25	40	AA91E040	570,25
50	AB91E050	579,20	50	AA91E050	579,20
65	AB91E065	605,20	65	AA91E065	605,20
80	AB91E080	792,35	80	AA91E080	792,35
100	AB91E100	821,60	100	AA91E100	821,60



A 92E - SOLDAR / SOLDAR

ATUADOR PNEUMÁTICO					
SIMPLES EFEITO			DUPLO EFEITO		
DN	COD.	€	DN	COD.	€
25	AS92E025	320,25	25	AD92E025	301,50
32	AS92E032	322,95	32	AD92E032	304,20
40	AS92E040	365,25	40	AD92E040	308,55
50	AS92E050	372,75	50	AD92E050	316,05
65	AS92E065	395,85	65	AD92E065	339,15
80	AS92E080	464,45	80	AD92E080	399,40
100	AS92E100	534,85	100	AD92E100	427,05

ATUADOR ELÉTRICO					
SIMPLES EFEITO			DUPLO EFEITO		
DN	COD.	€	DN	COD.	€
25	AB92E025	556,45	25	AA92E025	556,45
32	AB92E032	559,15	32	AA92E032	559,15
40	AB92E040	563,55	40	AA92E040	563,55
50	AB92E050	571,00	50	AA92E050	571,00
65	AB92E065	594,10	65	AA92E065	594,10
80	AB92E080	778,50	80	AA92E080	778,50
100	AB92E100	806,15	100	AA92E100	806,15

A I2PR VÁLVULA INOX DE ESFERA COM ATUADOR DOIS CORPOS PASSAGEM TOTAL ROSCADA

VÁLVULA

Corpo e Base: CF8M (AISI 316)

Eixo: AISI 304

Bola: AISI 316 com assento PTFE+15% GF

Temperatura: -10° C a 150° C

ATUADOR PNEUMÁTICO

Cálculo base com pressão a 6 bar (intervalo de trabalho 2 a 8 bar)

Temperatura: -20° C a 80° C

ATUADOR ELÉTRICO

Motor multivoltagem

Temperatura -20° C a 70° C.



ATUADOR PNEUMÁTICO					
SIMPLES EFEITO			DUPLO EFEITO		
Ø	COD.	€	Ø	COD.	€
1/4"	ASI2P061	163,50	1/4"	ADI2P061	146,05
3/8"	ASI2P062	163,50	3/8"	ADI2P062	146,05
1/2"	ASI2P063	164,70	1/2"	ADI2P063	147,30
3/4"	ASI2P064	167,80	3/4"	ADI2P064	152,05
1"	ASI2P065	209,30	1"	ADI2P065	153,35
1 1/4"	ASI2P066	256,15	1 1/4"	ADI2P066	198,10
1 1/2"	ASI2P067	308,80	1 1/2"	ADI2P067	235,65
2"	ASI2P068	371,60	2"	ADI2P068	258,75



ATUADOR ELÉTRICO					
BAIXA VOLTAGEM			ALTA VOLTAGEM		
Ø	COD.	€	Ø	COD.	€
1/4"	ABI2P061	323,00	1/4"	AAI2P061	323,00
3/8"	ABI2P062	323,00	3/8"	AAI2P062	323,00
1/2"	ABI2P063	324,20	1/2"	AAI2P063	324,20
3/4"	ABI2P064	382,75	3/4"	AAI2P064	382,75
1"	ABI2P065	389,15	1"	AAI2P065	389,15
1 1/4"	ABI2P066	540,75	1 1/4"	AAI2P066	540,75
1 1/2"	ABI2P067	549,05	1 1/2"	AAI2P067	549,05
2"	ABI2P068	654,75	2"	AAI2P068	654,75

A I3PR VÁLVULA INOX DE ESFERA COM ATUADOR TRÊS CORPOS PASSAGEM TOTAL ROSCADA

VÁLVULA

Corpo e Base: CF8M (AISI 316)

Eixo: AISI 304

Bola: AISI 316 com assento PTFE+15% GF

Temperatura: -10° C a 180° C

ATUADOR PNEUMÁTICO

Cálculo base com pressão a 6 bar (intervalo de trabalho 2 a 8 bar)

Temperatura: -20° C a 80° C

ATUADOR ELÉTRICO

Motor multivoltagem

Temperatura -20° C a 70° C.



ATUADOR PNEUMÁTICO					
SIMPLES EFEITO			DUPLO EFEITO		
Ø	COD.	€	Ø	COD.	€
1/2"	ASI3P063	171,95	1/2"	ADI3P063	154,50
3/4"	ASI3P064	178,60	3/4"	ADI3P064	162,85
1"	ASI3P065	222,25	1"	ADI3P065	166,20
1 1/4"	ASI3P066	234,70	1 1/4"	ADI3P066	207,65
1 1/2"	ASI3P067	291,90	1 1/2"	ADI3P067	227,10
2"	ASI3P068	350,90	2"	ADI3P068	250,15
2 1/2"	ASI3P069	510,05	2 1/2"	ADI3P069	432,10
3"	ASI3P06A	665,35	3"	ADI3P06A	526,95
4"	ASI3P06C	1.348,80	4"	ADI3P06C	894,80



ATUADOR ELÉTRICO					
BAIXA VOLTAGEM			ALTA VOLTAGEM		
Ø	COD.	€	Ø	COD.	€
1/2"	ABI3P063	331,40	1/2"	AAI3P063	331,40
3/4"	ABI3P064	393,60	3/4"	AAI3P064	393,60
1"	ABI3P065	402,05	1"	AAI3P065	402,05
1 1/4"	ABI3P066	557,85	1 1/4"	AAI3P066	557,85
1 1/2"	ABI3P067	568,05	1 1/2"	AAI3P067	568,05
2"	ABI3P068	673,75	2"	AAI3P068	673,75
2 1/2"	ABI3P069	793,25	2 1/2"	AAI3P069	793,25
3"	ABI3P06A	1.031,55	3"	AAI3P06A	1.031,55
4"	ABI3P06C	1.537,00	4"	AAI3P06C	1.537,00

A I3PB VÁLVULA INOX DE ESFERA COM ATUADOR TRÊS CORPOS PASSAGEM TOTAL BUTT WELD

VÁLVULA

Corpo e Base: CF8M (AISI 316)

Eixo: AISI 316

Bola: AISI 316 com assento PTFE+15% GF

Temperatura: -20° C a 180° C

ATUADOR PNEUMÁTICO

Cálculo base com pressão a 6 bar (intervalo de trabalho 2 a 8 bar)

Temperatura: -20° C a 80° C

ATUADOR ELÉTRICO

Motor multivoltagem

Temperatura -20° C a 70° C.



ATUADOR PNEUMÁTICO					
SIMPLES EFEITO			DUPLO EFEITO		
Ø	COD.	€	Ø	COD.	€
1/2"	ASI3PB63	172,50	1/2"	ADI3PB63	156,85
3/4"	ASI3PB64	178,65	3/4"	ADI3PB64	162,90
1"	ASI3PB65	220,65	1"	ADI3PB65	164,60
1 1/4"	ASI3PB66	241,50	1 1/4"	ADI3PB66	214,45
1 1/2"	ASI3PB67	299,05	1 1/2"	ADI3PB67	234,15
2"	ASI3PB68	365,85	2"	ADI3PB68	265,15
2 1/2"	ASI3PB69	509,85	2 1/2"	ADI3PB69	431,90
3"	ASI3PB6A	629,85	3"	ADI3PB6A	495,65
4"	ASI3PB6C	1.274,10	4"	ADI3PB6C	820,10



ATUADOR ELÉTRICO					
BAIXA VOLTAGEM			ALTA VOLTAGEM		
Ø	COD.	€	Ø	COD.	€
1/2"	ABI3PB63	333,75	1/2"	AAI3PB63	333,75
3/4"	ABI3PB64	393,65	3/4"	AAI3PB64	393,65
1"	ABI3PB65	400,45	1"	AAI3PB65	400,45
1 1/4"	ABI3PB66	564,60	1 1/4"	AAI3PB66	564,60
1 1/2"	ABI3PB67	575,10	1 1/2"	AAI3PB67	575,10
2"	ABI3PB68	688,70	2"	AAI3PB68	688,70
2 1/2"	ABI3PB69	793,05	2 1/2"	AAI3PB69	793,05
3"	ABI3PB6A	1.000,70	3"	AAI3PB6A	1.000,70
4"	ABI3PB6C	1.462,40	4"	AAI3PB6C	1.462,40

A I3PS VÁLVULA INOX DE ESFERA COM ATUADOR TRÊS CORPOS PASSAGEM TOTAL SOCKET WELD

VÁLVULA

Corpo e Base: CF8M (AISI 316)

Eixo: AISI 304

Bola: AISI 316 com assento PTFE+15% GF

Temperatura: -20° C a 180° C

ATUADOR PNEUMÁTICO

Cálculo base com pressão a 6 bar (intervalo de trabalho 2 a 8 bar)

Temperatura: -20° C a 80° C

ATUADOR ELÉTRICO

Motor multivoltagem

Temperatura -20° C a 70° C.



ATUADOR PNEUMÁTICO					
SIMPLES EFEITO			DUPLO EFEITO		
Ø	COD.	€	Ø	COD.	€
1/2"	ASI3PS63	173,50	1/2"	ADI3PS63	157,85
3/4"	ASI3PS64	179,15	3/4"	ADI3PS64	163,40
1"	ASI3PS65	224,60	1"	ADI3PS65	168,60
1 1/4"	ASI3PS66	234,70	1 1/4"	ADI3PS66	207,65
1 1/2"	ASI3PS67	291,90	1 1/2"	ADI3PS67	227,10
2"	ASI3PS68	366,40	2"	ADI3PS68	265,70
2 1/2"	ASI3PS69	507,30	2 1/2"	ADI3PS69	429,35
3"	ASI3PS6A	629,85	3"	ADI3PS6A	495,65
4"	ASI3PS6C	1.348,80	4"	ADI3PS6C	894,80



ATUADOR ELÉTRICO					
BAIXA VOLTAGEM			ALTA VOLTAGEM		
Ø	COD.	€	Ø	COD.	€
1/2"	ABI3PS63	334,75	1/2"	AAI3PS63	334,75
3/4"	ABI3PS64	394,10	3/4"	AAI3PS64	394,10
1"	ABI3PS65	404,45	1"	AAI3PS65	404,45
1 1/4"	ABI3PS66	557,85	1 1/4"	AAI3PS66	557,85
1 1/2"	ABI3PS67	568,05	1 1/2"	AAI3PS67	568,05
2"	ABI3PS68	689,25	2"	AAI3PS68	689,25
2 1/2"	ABI3PS69	790,50	2 1/2"	AAI3PS69	790,50
3"	ABI3PS6A	1.000,70	3"	AAI3PS6A	1.000,70
4"	ABI3PS6C	1.537,00	4"	AAI3PS6C	1.537,00

A I3VT/I3VL VÁLVULA INOX DE ESFERA COM ATUADOR TRÊS CORPOS PASSAGEM TIPO "T" / "L"

VÁLVULA

Corpo: CF8M (AISI 316)

Porca, Prensa e Eixo: AISI 316

Bola: AISI 316 com assento PTFE+15% GF

Temperatura: -20° C a 180° C

ATUADOR PNEUMÁTICO

Cálculo base com pressão a 6 bar (intervalo de trabalho 2 a 8 bar)

Temperatura: -20° C a 80° C

ATUADOR ELÉTRICO

Motor multivoltagem

Temperatura -20° C a 70° C.

ATUADOR PNEUMÁTICO

SIMPLES EFEITO		DUPLO EFEITO					
Ø	COD. T	COD. L	€	Ø	COD. T	COD. L	€
1/4"	ASI3VT61	ASI3VL61	195,10	1/4"	ADI3VT61	ADI3VL61	179,40
3/8"	ASI3VT62	ASI3VL62	195,35	3/8"	ADI3VT62	ADI3VL62	179,65
1/2"	ASI3VT63	ASI3VL63	196,05	1/2"	ADI3VT63	ADI3VL63	180,35
3/4"	ASI3VT64	ASI3VL64	230,00	3/4"	ADI3VT64	ADI3VL64	182,55
1"	ASI3VT65	ASI3VL65	250,70	1"	ADI3VT65	ADI3VL65	223,60
1 1/4"	ASI3VT66	ASI3VL66	361,50	1 1/4"	ADI3VT66	ADI3VL66	265,55
1 1/2"	ASI3VT67	ASI3VL67	384,00	1 1/2"	ADI3VT67	ADI3VL67	283,30
2"	ASI3VT68	ASI3VL68	536,05	2"	ADI3VT68	ADI3VL68	379,65

ATUADOR ELÉTRICO

BAIXA VOLTAGEM		ALTA VOLTAGEM					
Ø	COD. T	COD. L	€	Ø	COD. T	COD. L	€
1/4"	ABI3VT61	ABI3VL61	405,60	1/4"	AAI3VT61	AAI3VL61	405,60
3/8"	ABI3VT62	ABI3VL62	405,85	3/8"	AAI3VT62	AAI3VL62	405,85
1/2"	ABI3VT63	ABI3VL63	406,55	1/2"	AAI3VT63	AAI3VL63	406,55
3/4"	ABI3VT64	ABI3VL64	408,80	3/4"	AAI3VT64	AAI3VL64	408,80
1"	ABI3VT65	ABI3VL65	430,50	1"	AAI3VT65	AAI3VL65	430,50
1 1/4"	ABI3VT66	ABI3VL66	607,50	1 1/4"	AAI3VT66	AAI3VL66	607,50
1 1/2"	ABI3VT67	ABI3VL67	706,80	1 1/2"	AAI3VT67	AAI3VL67	706,80
2"	ABI3VT68	ABI3VL68	909,10	2"	AAI3VT68	AAI3VL68	909,10

A I2PB

VÁLVULA INOX DE ESFERA COM ATUADOR DOIS CORPOS PASSAGEM TOTAL FLANGEADA

VÁLVULA

Corpo: ASTM 351 (CF8M)

Eixo e Bola: ASTM A276 (316)

Assentos:(Bola e Corpo): PTFE+15% GF

Temperatura: -30° C a 150° C

ATUADOR PNEUMÁTICO

Cálculo base com pressão a 6 bar (intervalo de trabalho 2 a 8 bar)

Temperatura: -20° C a 80° C

ATUADOR ELÉTRICO

Motor multivoltagem

Temperatura -20° C a 70° C.



ATUADOR PNEUMÁTICO							
SIMPLES EFEITO				DUPLO EFEITO			
Ø	DN	COD.	€	Ø	DN	COD.	€
1/2"	15	ASI2B015	219,65	1/2"	15	ADI2B015	203,90
3/4"	20	ASI2B020	287,00	3/4"	20	ADI2B020	239,50
1"	25	ASI2B025	281,95	1"	25	ADI2B025	243,00
1 1/4"	32	ASI2B032	415,00	1 1/4"	32	ADI2B032	351,45
1 1/2"	40	ASI2B040	456,05	1 1/2"	40	ADI2B040	355,50
2"	50	ASI2B050	541,95	2"	50	ADI2B050	439,55
2 1/2"	65	ASI2B065	686,60	2 1/2"	65	ADI2B065	544,05
3"	80	ASI2B080	955,10	3"	80	ADI2B080	704,00
4"	100	ASI2B100	1.303,30	4"	100	ADI2B100	966,90
5"	125	ASI2B125	2.544,85	5"	125	ADI2B125	1.486,65
6"	150	ASI2B150	3.499,15	6"	150	ADI2B150	2.034,20



ATUADOR ELÉTRICO							
BAIXA VOLTAGEM				ALTA VOLTAGEM			
Ø	DN	COD.	€	Ø	DN	COD.	€
1/2"	15	ABI2B015	378,05	1/2"	15	AAI2B015	378,05
3/4"	20	ABI2B020	467,45	3/4"	20	AAI2B020	467,45
1"	25	ABI2B025	470,30	1"	25	AAI2B025	470,30
1 1/4"	32	ABI2B032	693,25	1 1/4"	32	AAI2B032	693,25
1 1/2"	40	ABI2B040	696,45	1 1/2"	40	AAI2B040	696,45
2"	50	ABI2B050	827,80	2"	50	AAI2B050	827,80
2 1/2"	65	ABI2B065	1.051,35	2 1/2"	65	AAI2B065	1.051,35
3"	80	ABI2B080	1.403,00	3"	80	AAI2B080	1.403,00
4"	100	ABI2B100	1.498,05	4"	100	AAI2B100	1.498,05
5"	125	ABI2B125	1.914,65	5"	125	AAI2B125	1.914,65
6"	150	ABI2B150	2.279,55	6"	150	AAI2B150	2.279,55

COMPLEMENTOS

YT-3300 R POSICIONADOR ELECTROPNEUMÁTICO DIGITAL

Alumínio / IP66 / DC 4-20 mA / características de série -30° C a 85° C / 1,4 – 7 bar / 2.8Kg
 Consultar para opções (caixa inox, comunicação HART, recópia de PTM, fins de curso, extra low T^a, etc...)

COD.	€
ACPOSIO1	1.872,65

YT-1000 R POSICIONADOR ELECTROPNEUMÁTICO

Alumínio / IP66 / DC 4-20 mA / características de série -20° C a 70° C / 1,4 – 7 bar / 2.8Kg
 Consultar para opções (caixa inox, high-low T^a, recópia de PTM, fins de curso, indicador de cúpula, etc...)

COD.	€
ACPOSIO2	1.108,70

YT-1200 R POSICIONADOR PNEUMÁTICO

Alumínio / Sinal Entrada 0,2 – 1 bar / fornecido 1,4 – 7 bar / características de série -20° C a 70° C / 1,7Kg.
 Consultar para opções (caixa inox, high-low T^a, recópia PTM-5VR ext., fins de curso, indicador de cúpula, etc...)

COD.	€
ACPOSIO3	777,45

DPS POSICIONADOR DIGITAL PARA ATUADOR ELÉTRICO

Sistema de controlo digital para regulação mediante sinal 4/20mA ou 0/10V

DESCRIPCIÓN	COD.	€
KIT DPS J4C 20/85	ACPOSIO4	318,00
KIT DPS J4C-140/300	ACPOSIO5	530,00

BSR BLOCO DE SEGURANÇA PARA ATUADOR ELÉTRICO

Sistema de retorno á posição de segurança por bateria

DESCRIPCIÓN	COD.	€
KIT BSR J4C-20/85	ACBSR001	318,00
KIT BSR J4C-140/300	ACBSR002	441,65

PLACA ADAPTADORA DE CONTROLO DE VELOCIDADE PARA ATUADORES PNEUMÁTICOS

COD.	€
ACPLAC01	CONSULTAR



SILENCIADOR / REGULADOR DE ESCAPE

DESCRIÇÃO	COD.	€
SILENCIADOR	ACSILE01	3,35
REGULADOR DE ESCAPE	ACREGU01	5,65



REDUTOR MANUAL DESTACÁVEL (Simple e duplo efeito)

DESCRIÇÃO	COD.	€
REDUTOR MANUAL DESTAC. ACTS.NEUM. 52-105	ACRMD001	388,65
REDUTOR MANUAL DESTAC. ACTS.NEUM. 125-140	ACRMD002	494,65
REDUTOR MANUAL DESTAC. ACTS.NEUM. 160	ACRMD003	812,65
REDUTOR MANUAL DESTAC. ACTS.NEUM. 190-210	ACRMD004	1.448,65
REDUTOR MANUAL DESTAC. ACTS.NEUM. 240-300	ACRMD005	2.226,00

Nota: os acoplamentos não estão incluídos.



EXD FIM DE CURSO

Alumínio / Proteção EexdIICT6 / IP67 / M20 / Eixo e suporte em Inox / 2 micros eletromecânicos SPDT

Consultar para opções (Caixa Inox, detetores indutivos, etc...)

Para outras opções por favor consultar.

COD.	€
ACFINC01	424,00



CB FIM DE CURSO

PP+15% FV / IP67 / Tampa transparente ABS com visor de cúpula / Prensa e tampão M16 / Suporte regulável / 2 micros eletromecânicos SPDT

Consultar para opções (micros SPDT, detetores indutivos, etc...)

Para outras opções por favor consultar

COD.	€
ACFINC02	60,05

ELETROVÁLVULAS NAMUR

5/2

VOLTAGEM*	COD.	€
24V DC	ACEV5201	42,40
24V AC	ACEV5202	42,40
220V AC	ACEV5203	42,40



BIESTÁVEL 5 VIAS

VOLTAGEM*	COD.	€
24V DC	ACEVBI01	150,15
24V AC	ACEVBI02	150,15
220V AC	ACEVBI03	150,15



3/2

VOLTAGEM*	COD.	€
24V DC	ACEV3201	53,00
24V AC	ACEV3202	53,00
220V AC	ACEV3203	53,00



* Para outras voltagens por favor consultar.

VÁLVULAS DE **LATÃO**

Após vários anos de desenvolvimento e um crescimento contínuo, a marca SYC encontrou o seu espaço entre os especialistas no mercado das válvulas. A sua constante melhoria baseada nos parâmetros de segurança e qualidade permitiu-nos obter o reconhecimento deste mercado.

As válvulas SYC evoluíram, adequando-se às exigências dos diferentes mercados internacionais onde são comercializadas, cumprindo as normativas europeias em vigor.



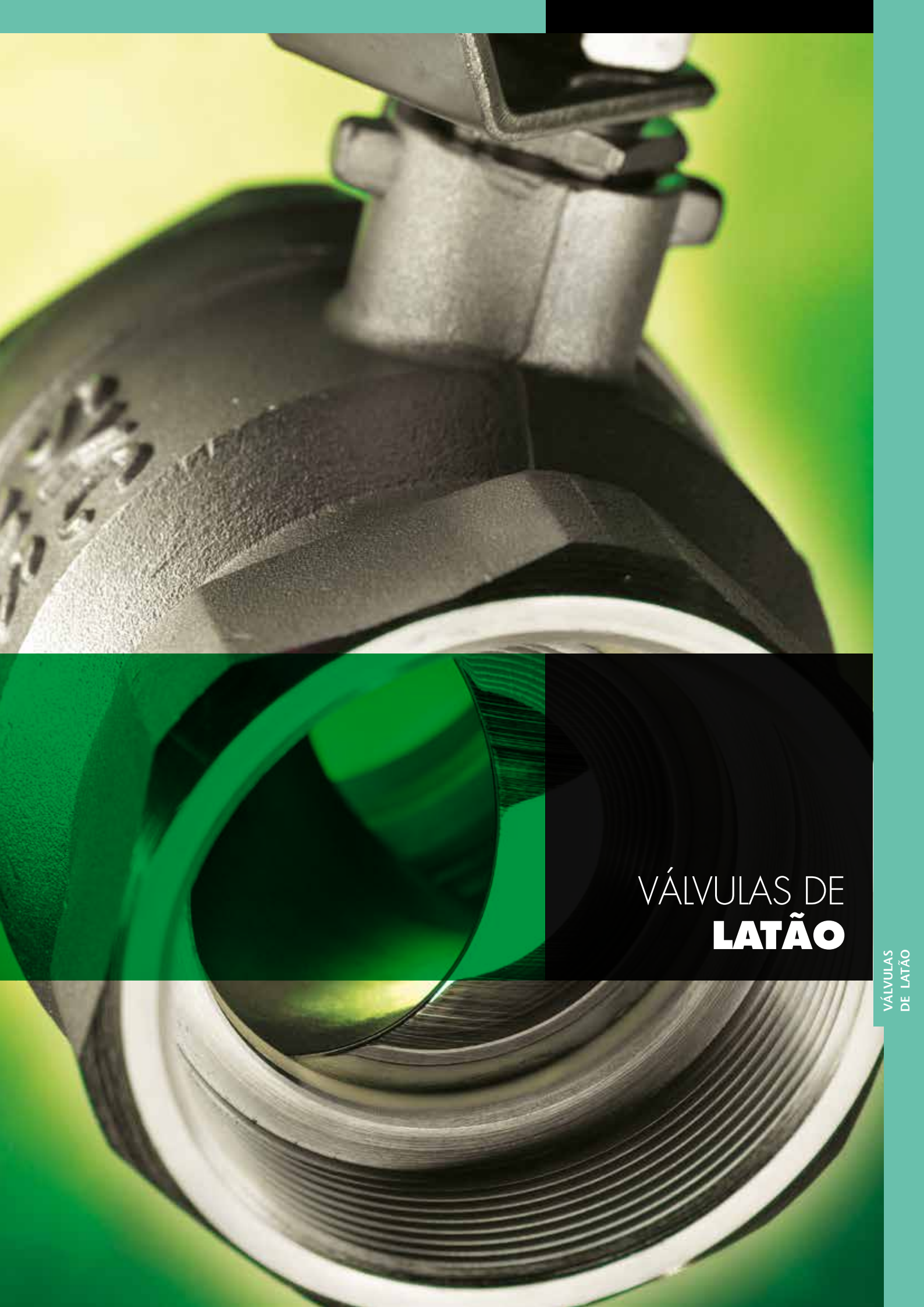

VÁLVULAS DE
LATÃO

VÁLVULAS DE ESFERA

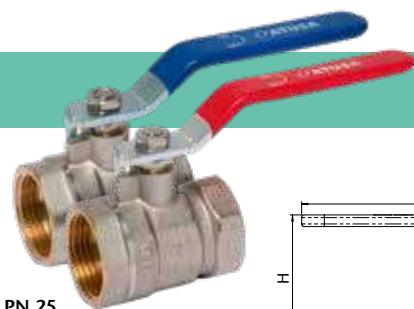

55/55R

VÁLVULA DE ESFERA F/F

PN 25.
 Latão EN 12165 niquelado.
 Rosca Gas, ISO 228/1.
 Temp. Máxima 120° C.
 Prensa estopa com guarnição de PTFE.
 Manipulo de aço com PVC vermelho ou azul.

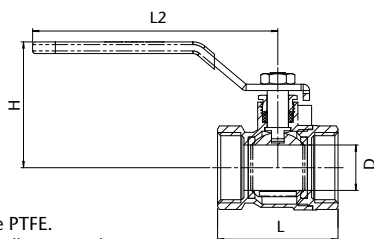

Ø	D mm.	L mm.	L2 mm.	H mm.		COD. AZUL	COD. VERMELHO	€
1/2"	15	46	90	50	100 10	VS055003	VSR05503	3,25
3/4"	17	51	100	54	80 10	VS055004	VSR05504	4,60
1"	22	58	110	58	64 8	VS055005	VSR05505	7,50
1 1/4"	29	72	140	77	32 8	VS055006	VSR05506	11,40
1 1/2"	35	81	140	82	24 6	VS055007	VSR05507	16,80
2"	44	96	165	86	12 3	VS055008	VSR05508	24,95
2 1/2"	57	124	236	108	4 2	VS05500A	VSR0550A	58,05
3"	68	144	236	116	4 2	VS05500B	VSR0550B	84,70
4"	85	166	236	128	2 1	VS05500C	VSR0550C	142,75

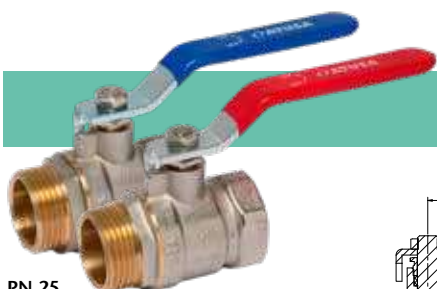

54/54R

VÁLVULA DE ESFERA M/F

PN 25.
 Latão EN 12165 niquelado.
 Rosca Gas, ISO 228/1.
 Temp. Máxima 120° C.
 Prensa estopa com guarnição de PTFE.
 Manipulo de aço com PVC vermelho ou azul.

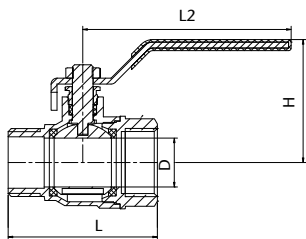

Ø	D mm.	L mm.	L2 mm.	H mm.		COD. AZUL	COD. VERMELHO	€
1/2"	15	54	85	47	100 10	VS054003	VSR05403	3,85
3/4"	17	61	96	52	80 10	VS054004	VSR05404	5,40
1"	22	67	115	60	64 8	VS054005	VSR05405	8,05
1 1/4"	29	83	132	71	32 8	VS054006	VSR05406	12,85
1 1/2"	35	92	140	79	24 6	VS054007	VSR05407	18,80
2"	44	110	145	87	12 3	VS054008	VSR05408	28,25

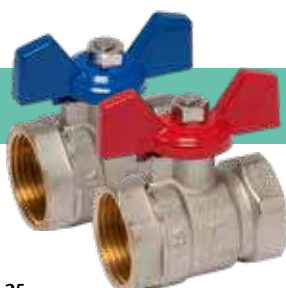

355/355R

VÁLVULA DE ESFERA F/F

PN 25.
 Latão EN 12165 niquelado.
 Rosca Gas, ISO 228/1.
 Temp. Máxima 120° C.
 Prensa estopa com guarnição de PTFE.
 Manipulo borboleta de alumínio vermelho ou azul.

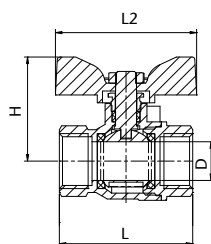

Ø	D mm.	L mm.	L2 mm.	H mm.		COD. AZUL	COD. VERMELHO	€
1/2"	15	46	56	40	100 10	VS355003	VSR35503	3,45
3/4"	17	51	56	42	80 10	VS355004	VSR35504	4,80
1"	22	58	66	55	64 8	VS355005	VSR35505	7,70



354/354R

VÁLVULA DE ESFERA M/F

PN 25.
 Latão EN 12165 niquelado.
 Rosca Gas, ISO 228/1.
 Temp. Máxima 120° C.
 Prensa estopa com guarnição de PTFE.
 Manipulo borboleta de alumínio vermelho ou azul.

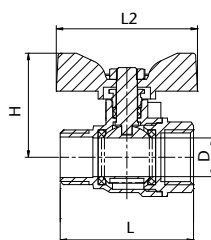

Ø	D mm.	L mm.	L2 mm.	H mm.		COD. AZUL	COD. VERMELHO	€
1/2"	15	54	56	40	100 10	VS354003	VSR35403	3,60
3/4"	17	61	56	42	80 10	VS354004	VSR35404	5,00
1"	22	67	66	55	64 8	VS354005	VSR35405	8,05

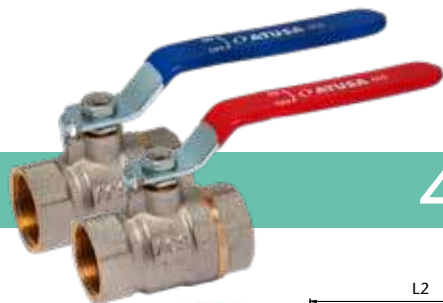

40/50

VÁLVULA DE ESFERA F/F

SISTEMA ANTI-GELO



PN 30.
Latão EN 12165 niquelado.
Rosca Gas, ISO 228/1.
Temp.máxima 120° C.
Prensa estopa com guarnição de PTFE.
Manípulo em aço com PVC vermelho ou azul.

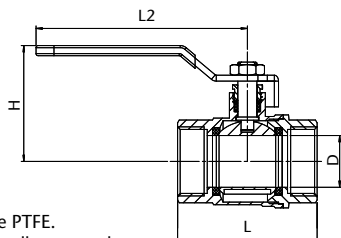

Ø	D mm.	L mm.	L2 mm.	H mm.		COD. AZUL	COD. VERMELHO	€
1/4"	9,5	40	81	41	150 15	VS040001	VS050001	3,55
3/8"	10	40	81	41	150 15	VS040002	VS050002	3,55
1/2"	15	51	81	44	80 10	VS040003	VS050003	4,70
3/4"	19	58	110	48	48 6	VS040004	VS050004	6,65
1"	24	64	116	61	32 4	VS040005	VS050005	10,25
1 1/4"	30	76	132	67	24 6	VS040006	VS050006	17,20
1 1/2"	37	88	142	88	16 4	VS040007	VS050007	24,45
2"	50	106	142	95	8 2	VS040008	VS050008	39,20
2 1/2"	59	127	235	121	4 1	VS04000A	VS05000A	74,75
3"	74	156	235	132	4 1	VS04000B	VS05000B	116,35
4"	90	179	283	136	3 1	VS04000C	VS05000D	171,10

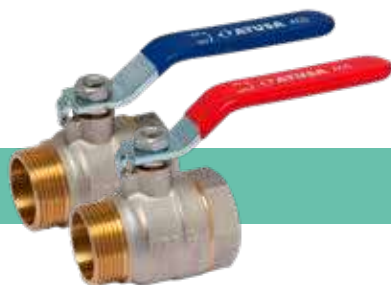

46/56

VÁLVULA DE ESFERA M/F

SISTEMA ANTI-GELO



PN 30.
Latão EN 12165 niquelado.
Rosca Gas, ISO 228/1.
Temp.máxima 120° C.
Prensa estopa com guarnição de PTFE.
Manípulo em aço com PVC vermelho ou azul.

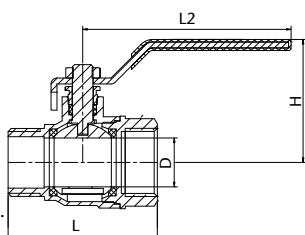

Ø	D mm.	L mm.	L2 mm.	H mm.		COD. AZUL	COD. VERMELHO	€
3/8"	10	41	81	41	150 15	VS046002	VS056002	3,80
1/2"	15	51	81	44	80 8	VS046003	VS056003	4,75
3/4"	19	58	110	48	48 6	VS046004	VS056004	6,70
1"	24	66	116	61	32 4	VS046005	VS056005	10,80
1 1/4"	30	77	132	67	24 6	VS046006	VS056006	17,75
1 1/2"	37	89	142	85	16 4	VS046007	VS056007	24,80
2"	50	107	142	95	8 2	VS046008	VS056008	40,70



340/350

VÁLVULA DE ESFERA F/F

SISTEMA ANTI-GELO



PN 30.
Latão EN 12165 niquelado.
Rosca Gas, ISO 228/1.
Temp.máxima 120° C.
Prensa estopa com guarnição de PTFE.
Manípulo borboleta de alumínio vermelho ou azul.

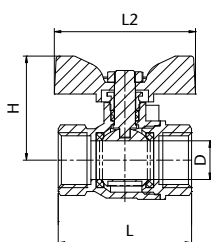

Ø	D mm.	L mm.	L2 mm.	H mm.		COD. AZUL	COD. VERMELHO	€
3/8"	10	40	54	36	150 15	VS340002	VS350002	3,55
1/2"	15	51	54	40	90 9	VS340003	VS350003	4,70
3/4"	19	58	54	44	80 8	VS340004	VS350004	6,65
1"	24	64	65	51	40 5	VS340005	VS350005	10,25



346/356

VÁLVULA DE ESFERA M/F

SISTEMA ANTI-GELO



PN 30.
Latão EN 12165 niquelado.
Rosca Gas, ISO 228/1.
Temp.máxima 120° C.
Prensa estopa com guarnição de PTFE.
Manípulo borboleta de alumínio vermelho ou azul.

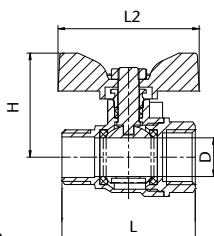

Ø	D mm.	L mm.	L2 mm.	H mm.		COD. AZUL	COD. VERMELHO	€
3/8"	10	41	54	36	150 15	VS346002	VS356002	3,80
1/2"	15	51	54	40	90 9	VS346003	VS356003	4,75
3/4"	19	58	54	44	80 8	VS346004	VS356004	6,70
1"	24	66	65	51	32 4	VS346005	VS356005	10,80



57

VÁLVULA DE ESFERA M/M

SISTEMA ANTI-GELO

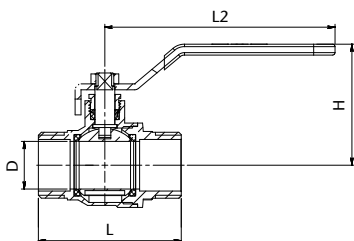

PN 30.
Latão EN 12165 niquelado.
Rosca Gas, ISO 228/1.
Temp.máxima 120° C.
Prensa estopa com guarnição de PTFE.
Manípulo de aço com PVC vermelho.

Ø	D mm.	L mm.	L2 mm.	H mm.		COD.	€
1/2"	15	58	81	44	80 8	VS057003	4,75
3/4"	19	64	110	47	48 6	VS057004	7,15
1"	24	72	116	61	32 4	VS057005	11,05
1 1/4"	30	86	132	67	24 6	VS057006	17,75
1 1/2"	37	100	142	85	16 4	VS057007	25,70
2"	50	115	142	95	8 2	VS057008	43,10



357

VÁLVULA DE ESFERA M/M

SISTEMA ANTI-GELO

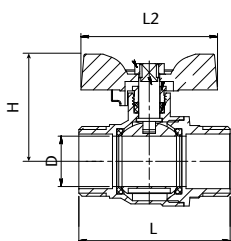

PN 30.
Latão EN 12165 niquelado.
Rosca Gas, ISO 228/1.
Temp.máxima 120° C.
Prensa estopa com guarnição de PTFE.
Manípulo de borboleta em alumínio vermelho.

Ø	D mm.	L mm.	L2 mm.	H mm.		COD.	€
1/2"	15	58	54	40	80 8	VS357003	4,75
3/4"	19	64	54	43	70 7	VS357004	7,15
1"	24	72	65	51	32 4	VS357005	11,05



50/I

VÁLVULA DE ESFERA F/F COM MANÍPULO EM AÇO INOX

SISTEMA ANTI-GELO

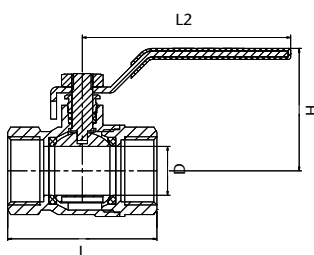

PN 30.
Latão EN 12165 niquelado.
Rosca Gas, ISO 228/1.
Temp.máxima 120° C.
Prensa estopa com guarnição de PTFE.
Manípulo de aço inoxidável com PVC vermelho.

Ø	D mm.	L mm.	L2 mm.	H mm.		COD.	€
1/4"	9,5	40	83	41	150 15	VS50I001	4,40
3/8"	10	40	83	41	150 15	VS50I002	4,40
1/2"	15	51	83	44	80 10	VS50I003	5,60
3/4"	19	58	83	48	48 6	VS50I004	7,40
1"	24	64	120	61	32 4	VS50I005	12,30
1 1/4"	30	76	130	67	24 6	VS50I006	20,15
1 1/2"	37	88	145	88	16 4	VS50I007	27,45
2"	50	106	145	95	8 2	VS50I008	47,15

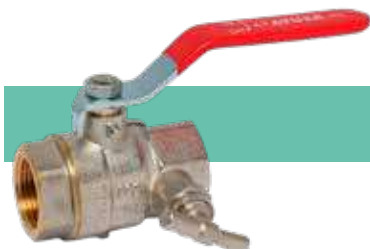

65

VÁLVULA DE ESFERA F/F COM PURGADOR E TAMPÃO

PN 30.

Latão EN 12165 niquelado.
Rosca Gas, ISO 228/1.
Temp.máxima 120° C.
Prensa estopa com guarnição de PTFE.
Manípulo de aço com PVC vermelho.
Tomadas laterais de 1/4".

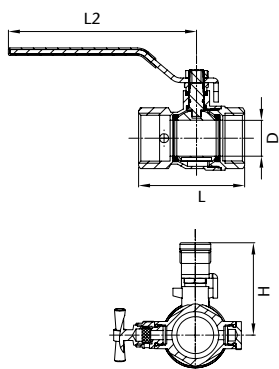

Ø	D mm.	L mm.	L2 mm.	H mm.		COD.	€
1/2"	15	56	97	49	40 4	VS065003	7,95
3/4"	20	63	97	52	24 6	VS065004	11,30
1"	24	71	125	59	24 6	VS065005	13,90
1 1/4"	30	82	140	74	16 4	VS065006	21,40
1 1/2"	37	94	140	80	6 2	VS065007	29,20
2"	45	103	165	89	6 2	VS065008	43,55



10

VÁLVULA DE ESFERA F/F COM MANÍPULO EM AÇO INOX

PN 40.
 Latão EN 12165 niquelado.
 Rosca Gas, ISO 228/1.
 Temp. máxima 120° C.
 Prensa estopa com guarnição de PTFE.
 Manípulo de aço inoxidável com PVC vermelho.

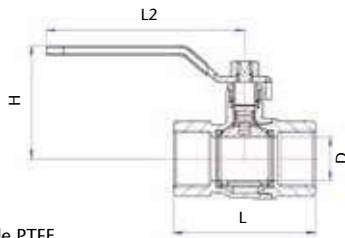

Ø	D mm.	L mm.	L2 mm.	H mm.		COD.	€
1/4"	10	45	81	42	150 15	VS010001	5,25
3/8"	10	45	81	42	150 15	VS010002	5,25
1/2"	15	60	85	50	56 7	VS010003	6,85
3/4"	20	70	85	54	48 6	VS010004	9,65
1"	25	82	114	65	24 6	VS010005	16,75
1 1/4"	32	99	142	77	16 4	VS010006	26,65
1 1/2"	40	106	142	83	8 2	VS010007	34,00
2"	50	126	150	94	8 2	VS010008	58,40



58

VÁLVULA DE ESFERA F/F COM QUADRA PRECINTÁVEL

PN 25.
 Latão EN 12165 niquelado.
 Rosca Gas, ISO 228/1.
 Temp. máxima 120° C.
 Prensa estopa com guarnição de PTFE.
 Quadra precintável.

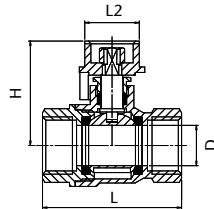

Ø	D mm.	L mm.	L2 mm.	H mm.		COD.	€
1/2"	15	51	20	38	90 9	VS058003	5,75
3/4"	19	58	20	42	80 8	VS058004	7,75
1"	24	64	20	52	48 6	VS058005	11,60
1 1/4"	30	76	20	58	32 4	VS058006	19,75
1 1/2"	37	88	24,5	68	16 4	VS058007	28,15
2"	50	106	24,5	77	8 2	VS058008	45,45



59

VÁLVULA DE ESFERA F/F COM QUADRA 28x28

PN 25.
 Latão EN 12165 niquelado.
 Rosca Gas, ISO 228/1.
 Temp. máxima 120° C.
 Prensa estopa com guarnição de PTFE.
 Quadra 28x28.

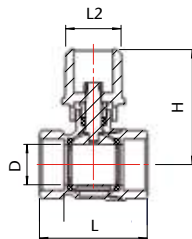

Ø	D mm.	L mm.	L2 mm.	H mm.		COD.	€
1/2"	15	51	28	60	80 10	VS059003	8,75
3/4"	19	58	28	63	48 6	VS059004	10,65
1"	24	64	28	68	36 9	VS059005	14,20
1 1/4"	30	76	28	74	24 6	VS059006	21,65
1 1/2"	37	88	28	80	16 4	VS059007	28,95
2"	50	106	28	89	8 2	VS059008	47,45



620

VÁLVULA DE ESFERA COM JUNÇÃO

PN 25.
 Latão EN 12165 niquelado.
 Rosca Gas, ISO 228/1.
 Temp. máxima 120° C.
 Prensa estopa com guarnição de PTFE.
 Manípulo de borboleta de alumínio vermelho.

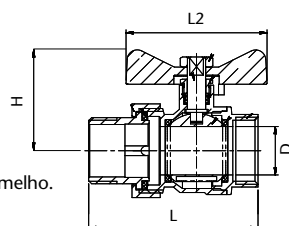

Ø	D mm.	L mm.	L2 mm.	H mm.		COD.	€
1/2"	15	70	54	36	70 7	VS620003	6,60
3/4"	19	76	54	40	60 6	VS620004	9,60
1"	24	84	70	50	32 4	VS620005	14,95
1 1/4"	30	103	76	59	24 6	VS620006	24,15

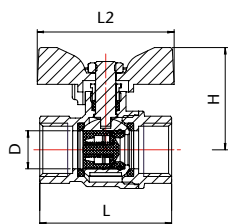

360

VÁLVULA DE ESFERA F/F COM RETENÇÃO INCORPORADA

PN 16.
Latão EN 12165 niquelado.
Rosca Gas, ISO 228/1.
Temp.máxima 95° C.
Prensa estopa com guarnição de PTFE.
Vedação da retenção em EPDM.
Mola Inox AISI 304.
Manipulo de borboleta de alumínio preto.

Ø	D mm.	L mm.	L2 mm.	H mm.		COD.	€
1/2"	15	52	54	40	90 9	VS360003	6,70
3/4"	20	64	54	44	70 7	VS360004	10,35
1"	25	74	65	51	32 4	VS360005	16,85

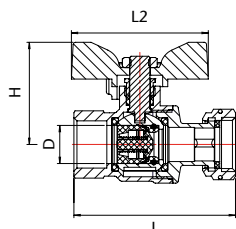

361

VÁLVULA DE ESFERA F/F PORCA LOUCA COM RETENÇÃO INCORPORADA

PN 16.
Latão EN 12165 niquelado.
Rosca Gas, ISO 228/1.
Temp.máxima 95° C.
Prensa estopa com guarnição de PTFE.
Fecho da retenção em EPDM.
Mola Inox AISI 304.
Manipulo de borboleta de alumínio preto.

Ø	D mm.	L mm.	L2 mm.	H mm.		COD.	€
1/2"	15	64	54	40	100 10	VS361003	7,40
3/4"	20	80	54	44	60 6	VS361004	11,95
1"	25	91	65	51	48 6	VS361005	18,60



1011/1011R

VÁLVULA DE ESFERA TIPO "MINI" F/F

PN 16.
Latão EN 12165 cromado.
Rosca Gas, ISO 228/1.
Temp.máxima 100° C.
Manipulo de borboleta azul ou vermelho com parafuso.

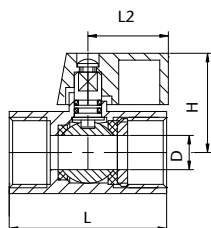

Ø	D mm.	L mm.	L2 mm.	H mm.		COD. AZUL	COD. VERMELHO	€
1/8"	7	40	23	27	200 20	VS101100	VSR10110	2,95
1/4"	8	40	23	27	200 20	VS101101	VSR10111	2,95
3/8"	8	40	23	27	200 20	VS101102	VSR10112	2,95
1/2"	10	47	23	29	160 16	VS101103	VSR10113	3,55
3/4"	15	50	23	31	100 10	VS101104	VSR10114	6,00



1012/1012R

VÁLVULA DE ESFERA TIPO "MINI" M/F

PN 16.
Latão EN 12165 cromado.
Rosca Gas, ISO 228/1.
Temp.máxima 100° C.
Manipulo de borboleta azul ou vermelho com parafuso.

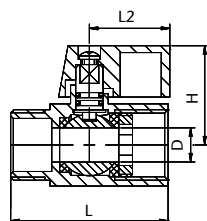

Ø	D mm.	L mm.	L2 mm.	H mm.		COD. AZUL	COD. VERMELHO	€
1/8"	7	40	23	27	200 20	VS101200	VSR10120	2,95
1/4"	8	40	23	27	200 20	VS101201	VSR10121	2,95
3/8"	8	40	23	27	200 20	VS101202	VSR10122	2,95
1/2"	10	47	23	29	160 16	VS101203	VSR10123	3,55
3/4"	15	50	23	31	100 10	VS101204	VSR10124	6,00



30/S

VÁLVULA DE ESFERA PARA SOLDAR

PN 30.
Latão EN 12165.
Extremos para soldar.
Temp. máxima 120° C.
Prensa estopa com guarnição em PTFE.
Manípulo de aço com PVC azul.

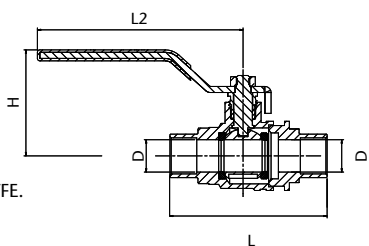

Ø	D mm.	L mm.	L2 mm.	H mm.		COD.	€
15 mm.	13,5	69	85	44	64 8	VS30S315	4,75
18 mm.	13,5	72	85	44	64 8	VS30S418	4,95
22 mm.	18	81	85	46	48 6	VS30S422	7,00
28 mm.	21	95	115	55	32 4	VS30S528	11,60
35 mm.	30	113	140	76	16 4	VS30S635	20,95
42 mm.	37	130	140	81	8 2	VS30S742	31,30
54 mm.	47	151	165	91	4 1	VS30S854	51,15



330/S

VÁLVULA DE ESFERA PARA SOLDAR

PN 30.
Latão EN 12165.
Extremos para soldar.
Temp. máxima 120° C.
Prensa estopa com guarnição em PTFE.
Manípulo de borboleta de alumínio vermelho.

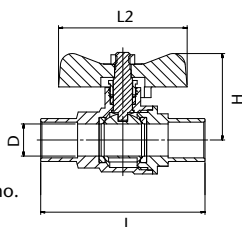

Ø	D mm.	L mm.	L2 mm.	H mm.		COD.	€
15 mm.	13,5	69	54	36	64 8	VS33S315	4,75
18 mm.	13,5	72	54	36	64 8	VS33S418	4,95
22 mm.	18	81	54	39	48 6	VS33S422	7,00



519

VÁLVULA DE ESFERA PARA DESCARGA DE CALDEIRA

PN 16.
Latão EN 12165.
Rosca Gas, ISO 228/1.
Temp. máxima 100° C.
Junta de estanquidade em PTFE e O-Ring em NBR.
Tomada de mangueira com tampão de segurança.
Com manípulo de cor preto.

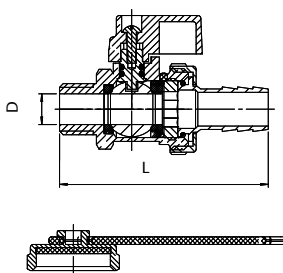

Ø	D mm.	L mm.		COD.	€
1/2"	10	70	64 8	VS519003	5,00



1302/1303

VÁLVULA DE ESFERA 3 VIAS 1302 PASSAGEM EM L / 1303 PASSAGEM EM T

PN 16.
Latão EN 12165 niquelado.
Rosca Gas, ISO 228/1.
Temp. máxima 120° C.
Prensa estopa com guarnição PTFE.
Bola esférica de 2 ou 3 vias com forma de "L" ou "T".
Manípulo de aço com PVC vermelho.

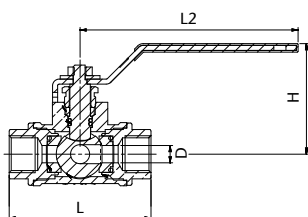

Ø	D mm.	L mm.	L2 mm.	H mm.		COD.	€
1/4"	10	81	125	64	24 6	VS130(2)(3)01	23,20
3/8"	10	81	125	64	24 6	VS130(2)(3)02	23,20
1/2"	10	82	125	64	24 6	VS130(2)(3)03	23,20
3/4"	15	91	125	67	15 5	VS130(2)(3)04	31,85
1"	20	105	161	72	12 4	VS130(2)(3)05	51,85
1 1/4"	25	116	161	79	9 3	VS130(2)(3)06	69,60
1 1/2"	32	140	220	92	4 1	VS130(2)(3)07	124,65
2"	40	164	220	98	2 1	VS130(2)(3)08	191,60

*(2): 1302 passagem em L
*(3): 1303 passagem em T



41

TORNEIRA DE JARDIM COM MANÍPULO EM ALUMÍNIO E ENCAIXE RÁPIDO

SISTEMA ANTI-GELO

PN 20.
Latão EN 12165 niquelado
Temp. máxima 100° C
Prensa estopa com guarnição PTFE
Manípulo de alumínio de cor vermelho
Acessório de encaixe rápido para mangueira.

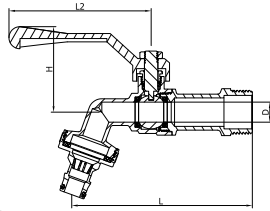

Ø	D mm.	L mm.	L2 mm.	H mm.		COD.	€
1/2" x 3/4"	10	98	86	50	64 8	VS041003	6,00
3/4" x 1"	12	112	86	51	48 6	VS041004	8,70
1" x 1"	15	120	100	54	32 4	VS041005	12,25



42

TORNEIRA DE JARDIM COM 2 SAÍDAS E ENCAIXE RÁPIDO

SISTEMA ANTI-GELO

PN 16.
Latão EN 12165 niquelado.
Temp. máxima 90° C.
Prensa estopa com guarnição PTFE.
Manípulo de aço com PVC azul.
Acessório de encaixe rápido para mangueira.

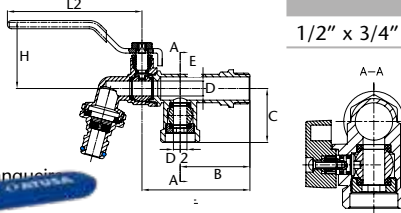

Ø	D mm.	D2 mm.	B mm.	E mm.	C mm.	L2 mm.	H mm.		COD.	€
1/2" x 3/4" x 3/4"	10	9	47	72	37	92	45	36 9	VS042344	9,90



43

TORNEIRA DE JARDIM COM MANÍPULO EM AÇO INOX E ENCAIXE RÁPIDO

SISTEMA ANTI-GELO

PN 16.
Latão EN 12165 niquelado.
Temp. máxima 90° C.
Prensa estopa com guarnição PTFE.
Manípulo de aço inoxidável com PVC azul.
Acessório de encaixe rápido para mangueira.

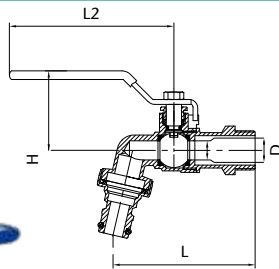

Ø	D mm.	L mm.	L2 mm.	H mm.		COD.	€
1/2" x 3/4"	10	74	90	45	80 10	VS043003	6,05
3/4" x 1"	12	91	100	47	48 6	VS043004	8,45
1" x 1 1/4"	15	94	110	53	32 4	VS043005	10,45



44

TORNEIRA DE JARDIM COM ORIFÍCIO PRECINTÁVEL



SISTEMA ANTI-GELO

PN 16.
Latão EN 12165 niquelado.
Temp. máxima 90° C.
Prensa estopa com guarnição PTFE.
Manípulo de aço com PVC azul.
Junção porta mangueira.
Prelator em nylon.

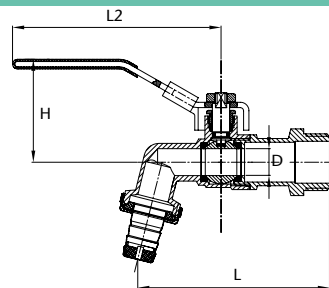

Ø	D mm.	L mm.	L2 mm.	H mm.		COD.	€
1/2" x 1/2"	10	73	97	45	80 10	VS044033	4,60
1/2" x 3/4"	10	74	97	45	80 10	VS044003	4,55
3/4" x 3/4"	12	91	97	45	48 6	VS044044	6,50
3/4" x 1"	12	91	97	47	48 6	VS044004	6,70
1" x 1 1/4"	15	94	114	58	32 4	VS044005	8,65



45

TORNEIRA DE JARDIM

SISTEMA ANTI-GELO

PN 16.
Latão EN 12165 niquelado.
Temp. máxima 90° C.
Manípulo de aço com PVC azul.
Junção porta mangueira.
Prelator em nylon.

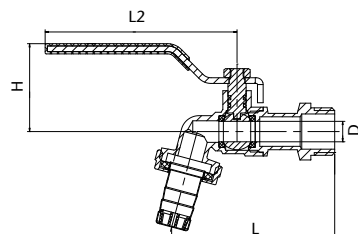

Ø	D mm.	L mm.	L2 mm.	H mm.		COD.	€
1/2" x 3/4"	9	71	81	38	80 10	VS045003	3,65
3/4" x 1"	12	87	85	42	48 6	VS045004	5,80
1" x 1 1/4"	14	94	105	47	32 4	VS045005	8,05



800

CAIXA DE REGA PARA JARDIM

Caixa com tampa de cor verde.
Acessório de encaixe rápido para mangueira.
Boca de rega vertical a esfera.
Temp. máxima 100° C.
Prensa estopa com guarnição de PTFE.
Manípulo borboleta de alumínio cor vermelho.

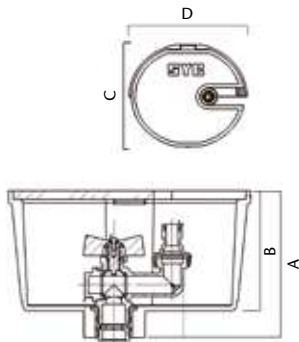

Ø	A mm.	B mm.	C mm.	D mm.		COD.	€
1/2" / 3/4" x 3/4"	123	100	178	200	2 1	VS800044	30,30
1/2" / 3/4" x 1"						VS800045	33,00



88

VÁLVULA DE ESFERA COM BOCA DE REGA VERTICAL

PN 16.
Latão EN 12165.
Acessório de encaixe rápido para mangueira.
Boca de rega vertical a esfera.
Temp. máxima 100° C.
Prensa estopa com guarnição de PTFE.
Manípulo borboleta de alumínio cor vermelho.

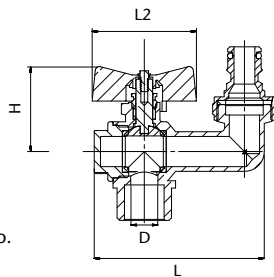

Ø	D mm.	L mm.	L2 mm.	H mm.		COD.	€
3/4" x 3/4"	13	82	50	41	48 6	VS088044	15,00
3/4" x 1"	13	84	50	43	48 6	VS088045	17,45



60

VÁLVULA DE ESQUADRIA

PN 10.
Latão EN 12165 cromado.
Temp. máxima 90° C.
Com parafuso de fixação no manípulo.
Espelho de aço inoxidável.

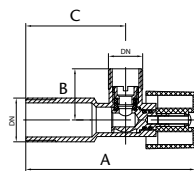

Ø	A mm.	B mm.	C mm.		COD.	€
1/2" x 3/8"	80	24	47	160 2	VS060002	2,40
1/2" x 1/2"	80	24	47	160 2	VS060003	2,50



60L

VÁLVULA DE ESQUADRIA COMPRIDA

PN 10.
Latão EN 12165 cromado.
Temp. máxima 90° C.
Com parafuso de fixação no manípulo.
Espelho de aço inoxidável.

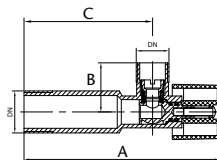

Ø	A mm.	B mm.	C mm.		COD.	€
1/2" x 3/8"	98	24	63	136 2	VS060L02	3,15



66

VÁLVULA DE ESQUADRIA COM FILTRO

PN 10.
Latão EN 12165 cromado.
Temp. máxima 90° C.
Com parafuso de fixação no manípulo.
Espelho de aço inoxidável.

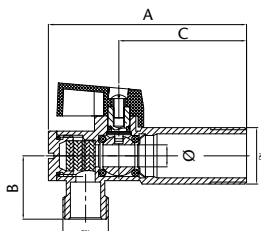

Ø	Ø mm.	A mm.	B mm.	C mm.		COD.	€
1/2" x 3/8"	8	72	23	47	138 2	VS066002	3,40
1/2" x 1/2"	8	72	23	47	138 2	VS066003	3,50
1/2" x 3/4"	8	72	23	47	138 2	VS066004	3,60



1100

VÁLVULA DE ESQUADRIA PARA MAQ. DE LAVAR

PN 10.
 Latão EN 12165 cromado.
 Temp. máxima 90° C.
 Com parafuso de fixação no manípulo.
 Espelho de aço inoxidável.

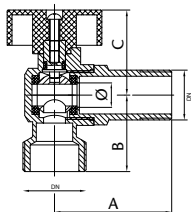

Ø	Ø mm.	A mm.	B mm.	C mm.		COD.	€
1/2" x 3/4"	9	40	32	35	95 1	VS110034	4,00



1110

VÁLVULA DE ESQUADRIA PARA MAQ. DE LAVAR

PN 10.
 Latão EN 12165 cromado.
 Temp. máxima 90° C.
 Com parafuso de fixação no manípulo.
 Espelho de aço inoxidável.

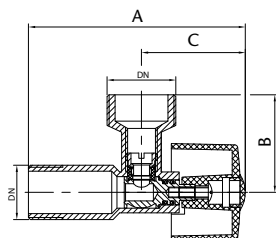

Ø	A mm.	B mm.	C mm.		COD.	€
1/2" x 3/4"	82	37	39	90 1	VS111034	3,50



1200

TORNEIRA DUPLA PARA MÁQ. DE LAVAR

PN 10.
 Latão EN 12165 cromado.
 Manípulos em ABS cromados.

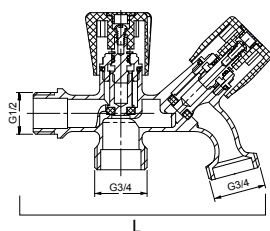

Ø	L mm.		COD.	€
1/2" x 3/4" x 3/4"	115	48 6	VS120003	12,00



1300

VÁLVULA DUPLA PARA MAQ. DE LAVAR / LAVATÓRIO

PN 10.
 Latão cromado conforme em 12165
 Temperatura máxima 110° C.
 Com parafuso para fixação do manípulo
 Espelho em aço inoxidável.

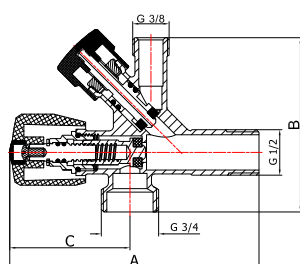

Ø	A mm.	B mm.	C mm.		COD.	€
1/2" x 3/4" x 3/8"	113	79	55	36 1	VS130342	9,20

VÁLVULA DE COMPORTA E ASSENTO



150/G

VÁLVULA DE COMPORTA COM CUNHA ELÁSTICA

PN 16.
Latão EN 12165.
Rosca Gas, ISO 228/1.
Temp. Máxima 80° C.
Fecho da comporta em latão + NBR vulcanizado.
Volante em aço vermelho.

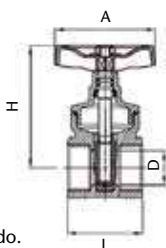

Ø	D mm.	L mm.	H mm.	A mm.		COD.	€
1/2"	13	39	58	50	96 12	VS150G03	6,40
3/4"	19	45	69	50	64 8	VS150G04	8,65
1"	25	51	80	59	48 6	VS150G05	13,90
1 1/4"	29	56	94	59	28 7	VS150G06	23,55
1 1/2"	36	61	128	78	12 3	VS150G07	32,30
2"	45	64	142	78	12 3	VS150G08	45,45
2 1/2"	60	100	170	100	3 1	VS150G0A	93,50
3"	70	100	195	100	3 1	VS150G0B	129,65
4"	99	107	260	130	2 1	VS150G0C	231,70



150

VÁLVULA DE COMPORTA EM LATÃO

PN 16.
Latão EN 12165.
Rosca Gas, ISO 228/1.
Temp. Máxima 80° C.
Fecho da comporta em latão.
Volante em aço vermelho.

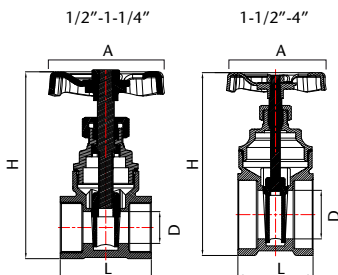

Ø	D mm.	L mm.	H mm.	A mm.		COD.	€
3/8"	13	38	78	50	96 12	VS150002	5,35
1/2"	13	38	78	50	48 12	VS150003	4,85
3/4"	15	41	82	50	48 12	VS150004	5,65
1"	20	45	96	59	32 8	VS150005	7,90
1 1/4"	26	51	115	59	24 4	VS150006	12,55
1 1/2"	33	51	124	70	12 3	VS150007	15,80
2"	42	61	156	70	8 2	VS150008	27,80
2 1/2"	60	66	202	98	10 1	VS15000A	47,50
3"	70	84	236	109	8 1	VS15000B	66,90
4"	93	85	296	131	4 1	VS15000C	119,70



172

VÁLVULA DE COMPORTA EM BRONZE

PN 16.
Corpo em bronze.
Rosca Gas, ISO 228/1.
Temp. Máxima 80° C.
Volante em aço vermelho.

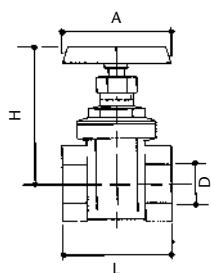

Ø	D mm.	L mm.	H mm.	A mm.		COD.	€
1/2"	15	38	68	45	160 20	VS172003	9,80
3/4"	19	45	78	50	100 20	VS172004	13,25
1"	24	48	92	55	80 10	VS172005	16,65
1 1/4"	32	51	108	60	40 10	VS172006	25,85
1 1/2"	37	58	125	70	35 5	VS172007	33,30
2"	47	62	145	80	25 5	VS172008	45,10
2 1/2"	60	76	175	100	14 1	VS17200A	83,40
3"	72	80	200	100	12 1	VS17200B	103,80
4"	93	96	240	120	6 1	VS17200D	174,45



173

VÁLVULA DE ASSENTO INCLINADO

PN 16.
Latão EN 12165.
Rosca Gas, ISO 228/1.
Temp. Máxima 80° C.
Vedação em borracha NBR.

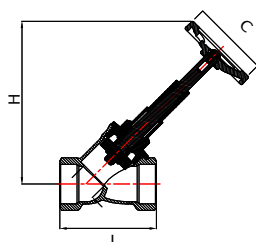

Ø	L mm.	C mm.	H mm.		COD.	€
1/2"	57	50	88	60 6	VS173003	7,15
3/4"	63	50	108	50 5	VS173004	10,05
1"	76	62	130	24 3	VS173005	16,30
1 1/4"	95	62	157	16 4	VS173006	31,10
1 1/2"	113	80	169	8 2	VS173007	49,55
2"	134	80	205	8 1	VS173008	83,10

VÁLVULAS DE RETENÇÃO, FUNDO DE POÇO E FILTROS

PN 16-10-8.
 Latão EN 12165.
 Rosca Gas, ISO 228/1.
 Temp. Máxima 80° C.
 Guia e disco em latão.
 Vedação em borracha NBR.
 Montagem horizontal e vertical.

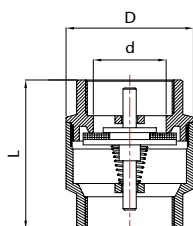

130

VÁLVULA DE RETENÇÃO DE MOLA

Ø	d mm.	L mm.	D mm.		COD.	€
3/8"	14	42	31	144 24	VS130002	3,80
1/2"	15	45	34	120 20	VS130003	4,00
3/4"	23	48	42	72 12	VS130004	5,80
1"	28	56	48	48 8	VS130005	7,70
1 1/4"	37	61	59	24 6	VS130006	11,10
1 1/2"	42	68	67	16 4	VS130007	16,30
2"	54	77	81	8 2	VS130008	26,05
2 1/2"	68	93	104	8 1	VS13000A	55,45
3"	78	97	111	6 1	VS13000B	65,20
4"	100	110	140	2 1	VS13000C	107,80



PN 25-16-10.
 Latão EN 12165.
 Rosca Gas, ISO 228/1.
 Temp. Máxima 80° C.
 Guia e disco em latão.
 Vedação em borracha NBR.
 Montagem horizontal e vertical.

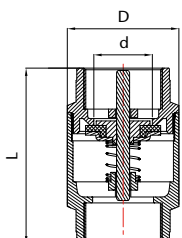

131

VÁLVULA DE RETENÇÃO DE MOLA REFORÇADA

Ø	d mm.	L mm.	D mm.		COD.	€
1/2"	16	57	35	90 15	VS131003	5,50
3/4"	22	64	42	48 12	VS131004	7,65
1"	25	75	48	36 9	VS131005	11,70
1 1/4"	32	83	61	24 6	VS131006	18,60
1 1/2"	41	93	71	8 2	VS131007	25,20
2"	50	100	87	8 2	VS131008	36,30
2 1/2"	67	120	119	6 1	VS13100A	77,85
3"	79	140	140	4 1	VS13100B	118,45
4"	100	158	154	3 1	VS13100C	177,40



PN 16-10-8.
 Latão EN 12165.
 Rosca Gas, ISO 228/1.
 Temp. Máxima 80° C.
 Guia e disco em latão.
 Vedação em borracha NBR.
 Filtro em aço inoxidável.

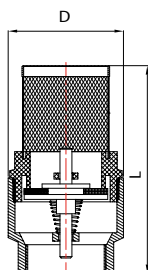

130/A

VÁLVULA DE RETENÇÃO DE FUNDO

Ø	L mm.	D mm.		COD.	€
1/2"	66	34	72 12	VS130A03	3,45
3/4"	71	43	48 12	VS130A04	4,80
1"	87	48	40 10	VS130A05	6,40
1 1/4"	97	59	12 3	VS130A06	9,15
1 1/2"	111	68	12 3	VS130A07	13,85
2"	129	81	6 3	VS130A08	23,15
2 1/2"	160	103	9 1	VS130A0A	39,10
3"	170	111	8 1	VS130A0B	56,30
4"	194	140	5 1	VS130A0C	81,00

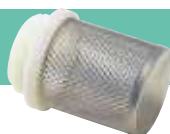

Filtro em aço inoxidável.
 Acessório em nylon.

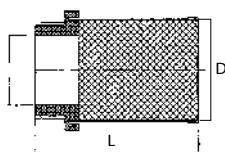

611

FILTRO EM INOX PARA VÁLVULA DE RETENÇÃO

Ø	L mm.	D mm.		COD.	€
1/2"	43	15	250 25	VS611003	0,50
3/4"	44	19	140 14	VS611004	0,55
1"	52	24	88 11	VS611005	0,75
1 1/4"	60	35	48 6	VS611006	1,05
1 1/2"	70	40	40 5	VS611007	1,30
2"	80	50	24 6	VS611008	1,85
2 1/2"	95	63	24 1	VS61100A	2,65
3"	102	78	8 1	VS61100B	3,25
4"	111	98	6 1	VS61100C	4,80



155

VÁLVULA DE RETENÇÃO DE CHARNEIRA VEDAÇÃO METÁLICA



PN 16-10-8.
Latão EN 12165.
Rosca Gas, ISO 228/1.
Temp. Máxima 100° C.
Vedação disco em latão.
Montagem horizontal ou vertical ascendente.

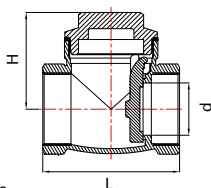

Ø	d mm.	L mm.	H mm.	📦		COD.	€
1/2"	14	48	35	72	12	VS155003	4,90
3/4"	20	52	40	60	10	VS155004	6,90
1"	24	63	45	24	6	VS155005	9,90
1 1/4"	30	74	52	20	5	VS155006	15,75
1 1/2"	32	80	54	16	4	VS155007	20,30
2"	48	98	67	8	1	VS155008	34,55
2 1/2"	61	120	81	5	1	VS15500A	53,80
3"	70	135	92	7	1	VS15500B	81,45
4"	86	160	103	4	1	VS15500C	141,45



155/A

VÁLVULA DE RETENÇÃO DE CHARNEIRA VEDAÇÃO EM NBR



PN 16-10-8.
Latão EN 12165.
Rosca Gas, ISO 228/1.
Temp. Máxima 80° C.
Vedação em borracha NBR.
Montagem horizontal ou vertical ascendente.

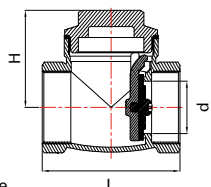

Ø	d mm.	L mm.	H mm.	📦		COD.	€
1/2"	14	48	35	72	12	VS155A03	4,90
3/4"	20	52	40	60	10	VS155A04	6,90
1"	24	63	45	24	6	VS155A05	9,90
1 1/4"	30	74	52	20	5	VS155A06	15,75
1 1/2"	32	80	54	16	4	VS155A07	20,30
2"	48	98	67	8	1	VS155A08	34,55
2 1/2"	61	120	81	5	1	VS155A0A	53,80
3"	70	135	92	7	1	VS155A0B	81,45
4"	86	160	103	4	1	VS155A0C	141,45



205

FILTRO DE LATÃO EM "Y"



PN 16.
Latão EN 12165.
Rosca Gas, ISO 228/1.
Temp. Máxima 120° C.
Filtro em aço inoxidável.

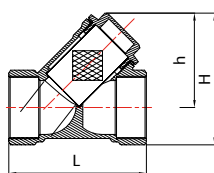

Ø	L mm.	H mm.	h mm.	📦		COD.	€
3/8"	46	41	31	144	12	VS205002	3,70
1/2"	57	53	40	72	12	VS205003	3,95
3/4"	66	62	46	40	10	VS205004	5,95
1"	74	72	52	36	9	VS205005	8,45
1 1/4"	96	88	63	16	4	VS205006	17,00
1 1/2"	104	101	72	12	2	VS205007	20,50
2"	125	122	91	8	1	VS205008	35,10
2 1/2"	146	148	107	4	1	VS20500A	75,20
3"	170	171	123	6	1	VS20500B	88,05
4"	210	214	152	2	1	VS20500C	176,00



196

VÁLVULA DE FUNDO COM FILTRO EM LATÃO

PN 16.
Latão EN 12165.
Rosca Gas, ISO 228/1.
Temp. Máxima 80° C.
Vedação em borracha NBR.

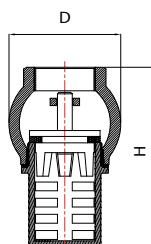

Ø	D mm.	H mm.	📦		COD.	€
1/2"	38	62	60	15	VS196003	5,00
3/4"	44	68	48	12	VS196004	6,25
1"	48	76	36	6	VS196005	7,50
1 1/4"	57	94	20	5	VS196006	12,15
1 1/2"	66	102	12	3	VS196007	16,10
2"	77	116	8	2	VS196008	25,60
2 1/2"	86	140	8	1	VS19600A	36,05
3"	111	149	8	1	VS19600B	53,95
4"	143	186	5	1	VS19600C	103,40

VÁLVULAS DE SEGURANÇA

560
VÁLVULA DE SEGURANÇA EM ESQUADRIA

PN 16.
Latão EN 12165.
Temp. Máxima 200° C.
Assento metálico.
Regulável de 1 a 12 bar.
Fornecida sem pré calibração.

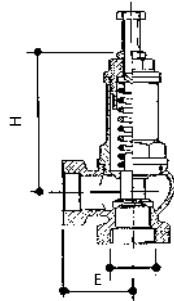

Ø	H mm.	E mm.		COD.	€
1/2"	76	36	50 1	VSS60003	28,65
3/4"	90	39	40 1	VSS60004	38,70
1"	98	47	25 1	VSS60005	52,55
1 1/4"	125	56	15 1	VSS60006	89,30
1 1/2"	140	63	10 1	VSS60007	120,30
2"	150	75	5 1	VSS60008	165,75
2 1/2"	181	86	2 1	VSS6000A	398,15
3"	205	88	2 1	VSS6000B	520,70

701
VÁLVULA DE SEGURANÇA PARA TERMOACUMULADOR M-F ORIENTÁVEL

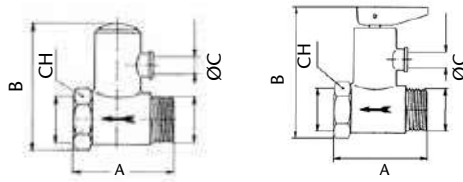

PN 16.
Latão EN 12165 niquelado.
Rosca gas, ISO 228/1.
Temp. máxima 120° C.
Inclui válvula anti retorno.
Descarga ORIENTÁVEL.



Ø	TARADA bar	A mm.	B mm.	C mm.		COD.	€	
SEM MANÍPULO	1/2"	8,5	40	49	6	250 25	VS701R03	4,15
COM MANÍPULO	1/2"	8,5	40	59	6	180 20	VS701RP3	4,85

702
PARA VÁLVULA DE SEGURANÇA TERMOACUMULADOR M-F

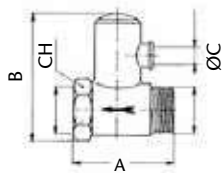

PN 16.
Latão EN 12165 niquelado.
Rosca Gas, ISO 228/1.
Temp. máxima 120° C.
Retenção incorporada.



Ø	TARADA bar	A mm.	B mm.	CH mm.	C mm.		COD.	€
1/2"	8,5	40	49	25	6	250 25	VS702003	3,40
3/4"	8,5	53	62	30	8	90 10	VS702004	7,30

703
VÁLVULA DE SEGURANÇA PARA TERMOACUMULADOR COM ALAVANCA M-F

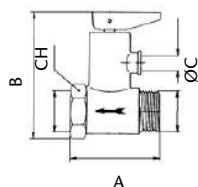

PN 16.
Latão EN 12165 niquelado.
Rosca Gas, ISO 228/1.
Temp. máxima 120° C.
Retenção incorporada.



Ø	TARADA bar	A mm.	B mm.	CH mm.	C mm.		COD.	€
1/2"	8,5	40	59	25	6	180 20	VS703003	4,35
3/4"	8,5	53	71	30	8	90 10	VS703004	8,25

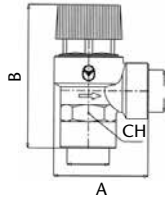

PN 10.
Latão EN 12165.
Rosca Gas, ISO 228/1.
Temp. máxima 120° C.
Obturador e membrana em EPDM.



705

VÁLVULA DE SEGURANÇA DE MEMBRANA F-F

Ø	TARADA bar	A mm.	B mm.	CH mm.		COD.	€
1/2"	3	42	66	25	108 12	VS705033	6,05
1/2"	7	42	66	25	108 12	VS705073	6,05



PN 10.
Latão EN 12165.
Rosca Gas, ISO 228/1.
Temp. máxima 120° C.
Obturador e membrana em EPDM.

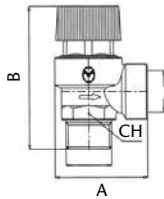

706

VÁLVULA DE SEGURANÇA DE MEMBRANA M-F

Ø	TARADA bar	A mm.	B mm.	CH mm.		COD.	€
1/2"	3	42	66	25	108 12	VS706033	6,05
1/2"	7	42	66	25	108 12	VS706073	6,05



PN 10.
Latão EN 12165.
Rosca Gas, ISO 228/1.
Temp. máxima 120° C.
Obturador e membrana em EPDM.
Tomada Fêmea de 1/4 ".

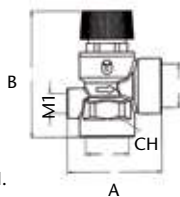

707

VÁLVULA DE SEGURANÇA DE MEMBRANA M-F COM TOMADA

Ø	TARADA bar	A mm.	B mm.	CH mm.		COD.	€
1/2"	3	50	74	25	90 10	VS707033	7,80



PN 10.
Latão EN 12165.
Rosca Gas, ISO 228/1.
Temp. máxima 120° C.
Obturador e membrana em EPDM.
Abertura da válvula a 90° C ou 3 bar.
Capacidade de descarga:
Ø 15 - 10 kW.
Ø 22 - 25 kW.

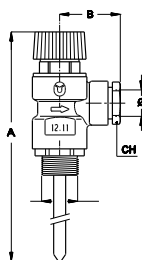

709

VÁLVULA DE SEGURANÇA DUPLA FUNÇÃO TEMPERATURA-PRESSÃO

Ø	TARADA bar	A mm.	B mm.	CH mm.		COD.	€
1/2" M x Ø15	3	186	35	21	24 1	VS709335	30,40
3/4" M x Ø22	3	192	39	27	24 1	VS709342	46,40

REDUTORES DE PRESSÃO

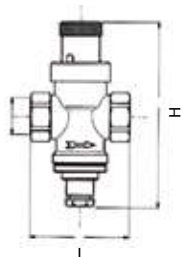
140
REDUTOR DE PRESSÃO DE PISTÃO PN 15

Ø	H mm.	L mm.		COD.	€
1/2"	112	60	50 1	RP140003	14,35
3/4"	113	60	50 1	RP140004	15,05

PN 15.
 Latão EN 12165 niquelado.
 Extremos rosca gas, F/F, ISO 228/1.
 Temp. máxima 80° C.
 Assento em latão.
 Regulação de 1 a 4 bar.
 Pré regulado a 3 bar.

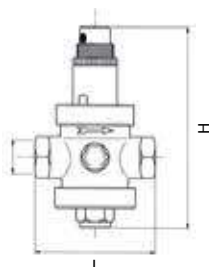
143
REDUTOR DE PRESSÃO DE PISTÃO PN 25

Ø	H mm.	L mm.		COD.	€
1/2"	120	75	25 1	RP143003	23,45
3/4"	150	85	20 1	RP143004	37,55
1"	160	89	15 1	RP143005	43,85
1 1/4"	220	125	6 1	RP143006	92,15
1 1/2"	220	130	6 1	RP143007	95,35
2"	250	138	4 1	RP143008	152,00
2 1/2"	260	145	4 1	RP14300A	217,00
3"	285	177	3 1	RP14300B	320,80
4"	310	190	2 1	RP14300C	824,85

PN 25.
 Latão EN 12165.
 Extremos rosca gas, F/F, ISO 228/1.
 Temp. máxima 80° C.
 Assento em aço inoxidável AISI 303.
 Regulação de 0,5 a 6 bar.
 Pré regulado a 3 bar.

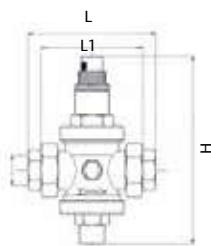
146
REDUTOR DE PRESSÃO DE PISTÃO COM JUNÇÃO PN 25

Ø	H mm.	L mm.	L1 mm.		COD.	€
1/2"	120	112	75	20 1	RP146003	29,35
3/4"	160	135	88	10 1	RP146004	51,50
1"	166	140	93	10 1	RP146005	54,90
1 1/4"	220	170	110	6 1	RP146006	101,75
1 1/2"	220	175	110	6 1	RP146007	109,10
2"	250	200	130	3 1	RP146008	177,25

PN 25.
 Latão EN 12165.
 Extremos rosca gas, F/F, ISO 228/1.
 Temp. máxima 80° C.
 Assento em aço inoxidável AISI 303.
 Regulação de 0,5 a 6 bar.
 Pré regulado a 3 bar.

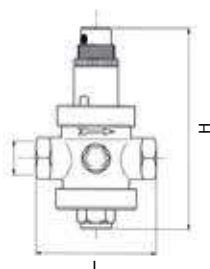
148
REDUTOR DE PRESSÃO DE PISTÃO PN 40

Ø	H mm.	L mm.		COD.	€
1/2"	143	75	25 1	RP148003	43,95
3/4"	174	85	20 1	RP148004	58,50
1"	180	91	15 1	RP148005	73,75
1 1/4"	220	116	6 1	RP148006	135,50
1 1/2"	220	125	6 1	RP148007	181,80
2"	250	140	4 1	RP148008	241,00
2 1/2"	260	145	4 1	RP14800A	277,20

PN 40.
 Latão EN 12165.
 Extremos rosca gas, F/F, ISO 228/1.
 Temp. máxima 80° C.
 Assento em aço inoxidável AISI 303.
 Regulação de 1 a 8 bar.
 Pré regulado a 3 bar.



149

REDUTOR DE PRESSÃO DE PISTÃO PN 30 FLANGEADO

PN 30.
Flanges PN16.
Corpo em bronze UNI EN 1982
Fecho em aço inoxidável AISI 303.
Juntas tóricas de NBR.
Temp. máxima 80° C.
Regulação de 1,5 a 7 bar.
Pré regulado a 3 bar.

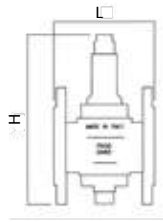

DN	H mm.	L mm.	Box		COD.	€
50	250	165	2	1	RP149050	788,60
65	260	170	2	1	RP149065	915,55
80	285	172	2	1	RP149080	1.061,70
100	340	200	1	1	RP149100	1.235,85



156

FILTRO DE AUTO-LIMPEZA DE 100 MICRONS

PN 25.
Latão EN 12165.
Extremos rosca gas, F/F, ISO 228/1.
Temp. máxima 130° C.
Tomada de manómetro na entrada e saída.
Torneira para limpeza de 3/8".
Filtro em aço inoxidável AISI 304 de 100 microns.
Disponível também com filtro de 300 micras.

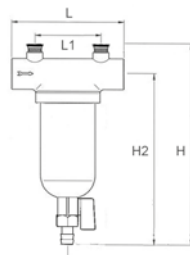

Ø	L mm.	L1 mm.	H mm.	H2 mm.	Box		COD.	€
1/2"	118	70	196	165	10	1	RP156003	60,85
3/4"	118	70	196	165	10	1	RP156004	60,85
1"	123	72	220	180	6	1	RP156005	78,25
1 1/4"	123	72	220	180	6	1	RP156006	78,25
1 1/2"	153	98	258	214	6	1	RP156007	102,05
2"	153	98	258	214	6	1	RP156008	102,05



145

AMORTECEDOR ANTI GOLPE DE ARIETE

PN 10.
Latão EN 12165.
Rosca Gas M, ISO 228/1.
Temp. máxima 130° C.
Mola de aço inoxidável.
Pressão máxima de retorno 40 bar.

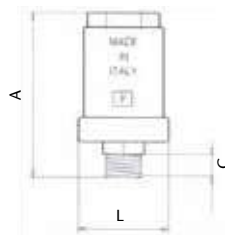

Ø	L mm.	A mm.	C mm.	Box		COD.	€
1/2"	51	93	12	50	1	RP145003	16,35

FUNCIONAMENTO DO AMORTECEDOR DO GOLPE DE ARIETE.

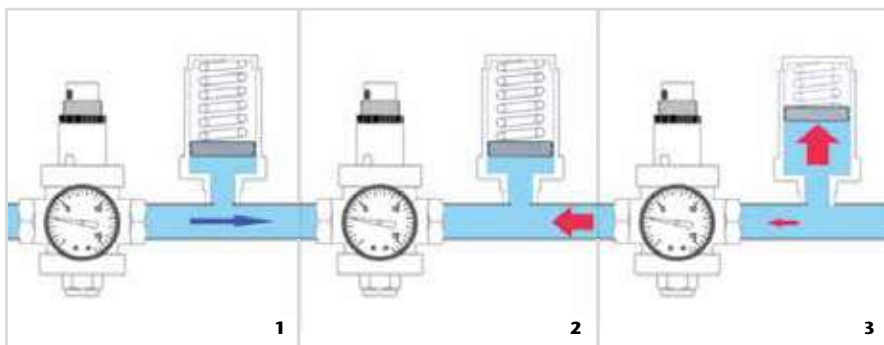

1. Funcionamento normal.
2. Chegada do golpe de ariete.
3. Absorção do golpe de ariete.

INSTALAÇÃO CORRETA

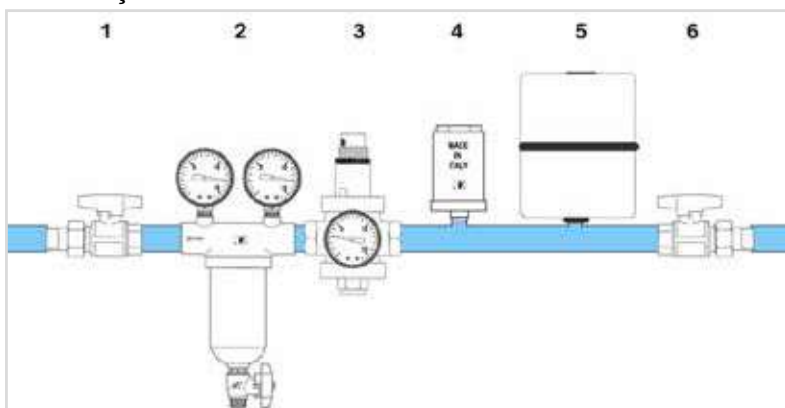

1. Válvula de esfera.
2. Filtro auto - limpeza.
3. Redutor de pressão.
4. Anti golpe de ariete.
5. Vaso de expansão.
6. Válvula de esfera.

MANÓMETROS



400

MANÓMETRO Ø 50

Caixa de Aço Preto.
Interiores e acessório em latão.
Rosca macho de 1/4".
Ligação posterior.
Dupla escala: bar/psi.
Fabricados conforme norma EN 837-1.
Precisão CL 1,6.

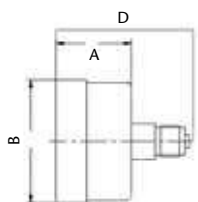

RANGO PRESIÓN	A mm.	B mm.	D mm.		COD.	€
0 - 2	29	54	47	125 1	VS400002	3,30
0 - 4	29	54	47	125 1	VS400004	3,30
0 - 6	29	54	47	125 1	VS400006	3,30
0 - 10	29	54	47	125 1	VS400010	3,30
0 - 16	29	54	47	125 1	VS400016	3,30



410

MANÓMETRO Ø 50

Caixa de Aço Preto.
Interiores e acessório em latão.
Rosca macho de 1/4".
Ligação inferior.
Dupla escala: bar/psi.
Fabricados conforme norma EN 837-1.
Precisão CL 1,6.

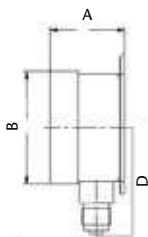

RANGO PRESIÓN	A mm.	B mm.	D mm.		COD.	€
0 - 2	29	54	45	180 1	VS410002	3,30
0 - 4	29	54	45	180 1	VS410004	3,30
0 - 6	29	54	45	180 1	VS410006	3,30
0 - 10	29	54	45	180 1	VS410010	3,30
0 - 16	29	54	45	180 1	VS410016	3,30



420

MANÓMETRO Ø 63

Caixa de Aço Preto.
Interiores e acessório em latão.
Rosca macho de 1/4".
Ligação inferior.
Dupla escala: bar/psi.
Fabricados conforme norma EN 837-1.
Precisão CL 1,6.

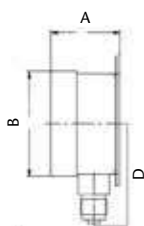

RANGO PRESIÓN	A mm.	B mm.	D mm.		COD.	€
0 - 2	30	63	52	120 1	VS420002	3,50
0 - 4	30	63	52	120 1	VS420004	3,50
0 - 6	30	63	52	120 1	VS420006	3,50
0 - 10	30	63	52	120 1	VS420010	3,50
0 - 16	30	63	52	120 1	VS420016	3,50



432

MANÓMETRO COM GLICERINA Ø 63

Caixa de Aço Inox AISI 304.
Interiores e acessório em latão.
Rosca macho de 1/4".
Ligação posterior.
Dupla escala: bar/psi.
Fabricados conforme Norma EN 837-1.
Precisão CL 1,6.

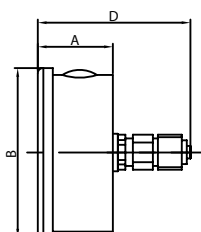

RANGO PRESIÓN	A mm.	B mm.	D mm.		COD.	€
0 - 2	30	68	61	64 1	VS432002	7,65
0 - 4	30	68	61	64 1	VS432004	7,65
0 - 6	30	68	61	64 1	VS432006	7,65
0 - 10	30	68	61	64 1	VS432010	7,65
0 - 16	30	68	61	64 1	VS432016	7,65
0 - 25	30	68	61	64 1	VS432025	7,65
0 - 60	30	68	61	64 1	VS432060	7,65
0 - 100	30	68	61	64 1	VS432100	7,65



430

MANÓMETRO COM GLICERINA Ø 63

Caixa de Aço Inox AISI 304.
 Interiores e acessório em latão.
 Rosca macho de 1/4".
 Ligação inferior.
 Dupla escala: bar/psi.
 Fabricados conforme norma EN 837-1.
 Precisão CL 1,6.

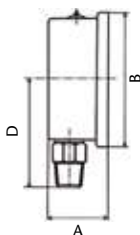

RANGO PRESIÓN	A mm.	B mm.	D mm.		COD.	€
0 - 2	30	68	55	100 1	VS430002	7,65
0 - 4	30	68	55	100 1	VS430004	7,65
0 - 6	30	68	55	100 1	VS430006	7,65
0 - 10	30	68	55	100 1	VS430010	7,65
0 - 16	30	68	55	100 1	VS430016	7,65
0 - 25	30	68	55	100 1	VS430025	7,65
0 - 60	30	68	55	100 1	VS430060	7,65
0 - 100	30	68	55	100 1	VS430100	7,65



440

MANÓMETRO COM GLICERINA Ø 100

Caixa de Aço Inox AISI 304.
 Interiores e acessório em latão.
 Rosca macho de 1/2".
 Ligação inferior.
 Dupla escala: bar/psi.
 Fabricados conforme norma EN 837-1.
 Precisão CL 1,6.

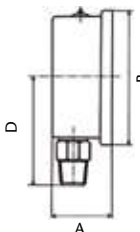

RANGO PRESIÓN	A mm.	B mm.	D mm.		COD.	€
0 - 2	36	109	83	36 1	VS440002	15,35
0 - 4	36	109	83	36 1	VS440004	15,35
0 - 6	36	109	83	36 1	VS440006	15,35
0 - 10	36	109	83	36 1	VS440010	15,35
0 - 16	36	109	83	36 1	VS440016	15,35
0 - 25	36	109	83	36 1	VS440025	15,35
0 - 60	36	109	83	36 1	VS440060	15,35
0 - 100	36	109	83	36 1	VS440100	15,35



431

MANÓMETRO COM GLICERINA Ø 63

Caixa de Aço Inox AISI 304.
 Interiores e acessório em Aço Inox. AISI 304.
 Rosca macho de 1/4".
 Ligação inferior.
 Dupla escala: bar/psi.
 Fabricados conforme Norma EN 837-1.
 Precisão CL. 1,6.

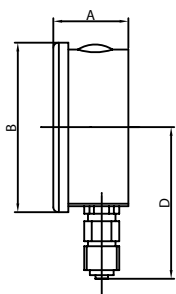

RANGO PRESIÓN	A mm.	B mm.	D mm.		COD.	€
0 - 2	30	68	60	100 1	VS431002	15,70
0 - 4	30	68	60	100 1	VS431004	15,70
0 - 6	30	68	60	100 1	VS431006	15,70
0 - 10	30	68	60	100 1	VS431010	15,70
0 - 16	30	68	60	100 1	VS431016	15,70
0 - 25	30	68	60	100 1	VS431025	15,70
0 - 60	30	68	60	100 1	VS431060	15,70
0 - 100	30	68	60	100 1	VS431100	15,70



441

MANÓMETRO COM GLICERINA Ø 100

Caixa de Aço Inox AISI 304.
 Interiores e acessório em Aço Inox. AISI 304.
 Rosca macho de 1/2".
 Ligação inferior.
 Dupla escala: bar/psi.
 Fabricados conforme Norma EN 837-1.
 Precisão CL. 1,6.

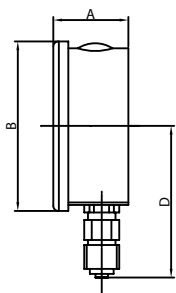

RANGO PRESIÓN	A mm.	B mm.	D mm.		COD.	€
0 - 6	36	109	85	36 1	VS441006	25,55
0 - 10	36	109	85	36 1	VS441010	25,55
0 - 16	36	109	85	36 1	VS441016	25,55
0 - 25	36	109	85	36 1	VS441025	25,55
0 - 60	36	109	85	36 1	VS441060	25,55
0 - 100	36	109	85	36 1	VS441100	25,55

VEDANTES

A90 VEDANTE ANAERÓBICO EM PTFE PARA UNIÕES METÁLICAS



	COD.	€
6	TLA90000	13,65

CARACTERÍSTICAS

Conteúdo da embalagem: 50ml
 Utilização em água quente e fria.
 Cumpre a norma EN 751-1 para gases combustíveis.
 Aprovação DVGW.
 Temperatura de serviço: -50° C a 150° C
 Absorve vibrações.
 Previne a corrosão.
 Lubrifica as ligações por ação do PTFE.
 Permite a desmontagem facilmente.
 Armazenar afastado da luz solar a temperaturas entre 5° C e 28° C.

BENEFÍCIOS

Permite testar instantaneamente a instalação.
 Aplicação direta, sem sujidade.
 Doseador fino: aplicação sem desperdício.
 Veda com um simples aperto.
 Vedação permanente.
 Permite preencher folgas até 0.35mm.

TEFLON FITA DE PTFE



Ø	DENSIDAD g/cm ³		COD.	€
0,1 mm. x 12 mm. x 12 mts	0,3	350 10	TC001212	0,36
0,1 mm. x 25 mm. x 50 mts	0,3	60 5	TC002550	2,80
0,1 mm. x 19 mm. x 50 mts	0,3	80 5	TC001950	2,30
0,2 mm. x 19 mm. x 15 mts	0,3	100 5	TC001915	1,45
0,1 mm. x 12 mm. x 10 mts	1,0	250 10	TCC01210	0,75



Recomendado para a vedação de tubagens e acessórios roscados.

Especial GAS
 DVGW CERT ZP 5143
 DIN 30660

TAPONES PARA TESTE DAS INSTALAÇÕES



Ø	COLOR		COD.	€
1/2 "	Azul	600 20	RAFUTPAZ	0,35
1/2 "	VERMELHO	600 20	RAFUTPRO	0,35

Tampão para teste de instalações e depósitos.
 Fabricado em ABS.
 Válido apenas para teste de instalação com água fria.
 Juntas de estanquidade em poliéster.
 Fornecido em bolsas de 20 unidades e 40 juntas de vedação.

ACESSÓRIOS



55R-54R
55-54 MANÍPULO

Ø	COD. VERMELHO	COD. AZUL	€
1/2"	VSR55M03	VS055M03	0,45
3/4"	VSR55M04	VS055M04	0,55
1"	VSR55M05	VS055M05	0,90
1 1/4"	VSR55M06	VS055M06	1,20
1 1/2"	VSR55M07	VS055M07	1,55
2"	VSR55M08	VS055M08	1,75
2 1/2" - 3"	VSR55MAB	VS055MAB	6,75
4"	VSR55MOC	VS055MOC	6,75



50-56
40-46 MANÍPULO

Ø	COD. VERMELHO	COD. AZUL	€
1/4" - 1/2"	VS050M13	VS040M13	0,45
3/4"	VS050M04	VS040M04	0,55
1"	VS050M05	VS040M05	0,90
1 1/4"	VS050M06	VS040M06	1,55
1 1/2" - 2"	VS050M78	VS040M78	1,65
2 1/2" - 3"	VS050MAB	VS040MAB	6,05
4"	VS050M0D	VS040M0D	7,35



10 MANÍPULO

Ø	COD.	€
1/2" - 3/4"	VS010M34	1,60
1"	VS010M05	2,90
1 1/4" - 1 1/2"	VS010M67	5,30
2"	VS010M08	6,20



355R-354R
355-354 BORBOLETA

Ø	COD. VERMELHO	COD. AZUL	€
1/2"-3/4"	VSR35M34	VS355M34	0,55
1"	VSR35M05	VS355M05	0,90



350-356
340-346 BORBOLETA

Ø	COD. VERMELHO	COD. AZUL	€
3/8"-3/4"	VS350M24	VS340M24	0,55
1"	VS350M05	VS340M05	0,90



30/S MANÍPULO

Ø	COD.	€
1/2" - 3/4"	VS30SM34	0,50
1"	VS30SM05	0,90
1 1/4"-1 1/2"	VS30SM67	1,60
2"	VS30SM08	2,20



43 MANÍPULO

Ø	COD.	€
1/2"-3/4"	VS043M34	1,45
1"	VS043M05	1,95



44 MANÍPULO

Ø	COD.	€
1/2" - 3/4"	VS044M34	0,80
1"	VS044M05	1,45



45 MANÍPULO

Ø	COD.	€
1/2" - 3/4"	VS045M34	0,45
1"	VS045M05	0,80



173 VOLANTE

Ø	COD.	€
1/2" - 3/4"	VS173V34	0,80
1" - 1 1/4"	VS173V56	1,25
1 1/2" - 2"	VS173V78	2,35



205 MALHA

Ø	COD.	€
1/2"	VS205M33	0,50
3/4"	VS205M34	0,55
1"	VS205M35	0,80
1/2"	VS205M03	0,45
3/4"	VS205M04	0,50
1"	VS205M05	0,75
1 1/4"	VS205M06	0,80
1 1/2"	VS205M07	0,95
2"	VS205M08	1,25
2 1/2"	VS205M0A	2,25
3"	VS205M0B	3,25
4"	VS205M0C	4,45

300 µm 500 µm 1200 µm



ENCAIXE RÁPIDO
PARA MANGUEIRA.

Ø		COD.	€
3/4"	400 40	VS046RR4	1,55
1"	300 30	VS046RR5	2,05



150 VOLANTE

Ø	COD.	€
1/2" - 3/4"	VS150V34	0,60
1" - 1 1/4"	VS150V56	0,65
1 1/2" - 2"	VS150V78	1,20
2 1/2"	VS150V0A	3,05
3"	VS150V0B	4,45
4"	VS150V0C	5,55



205 JUNTA

Ø	COD.	€
1/2"	VS205J03	0,20
3/4"	VS205J04	0,25
1"	VS205J05	0,30



RACOR
PORTAMANGUEIRA

Ø		COD.	€
3/4"	140 20	VS046RP4	0,65
1"	60 15	VS046RP5	1,15
1 1/4"	30 10	VS046RP6	1,75

FLUTUADORES E BOIAS

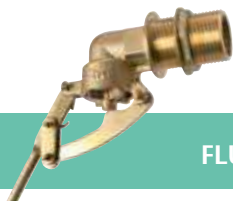

FLUTUADOR COM VARÃO ROSCADO

Ø	PORCA VARILLA		COD.	€
3/8"	3/16	50 5	VS91LR02	7,20
1/2"	6/100	50 5	VS91LR03	6,80
3/4"	7/100	50 5	VS91LR04	9,90
1"	8/100	25 5	VS91LR05	15,45
1 1/4"	9/100	10 1	VS91LR06	34,95
1 1/2"	9/100	10 1	VS91LR07	45,30
2"	9/100	6 1	VS91LR08	77,60

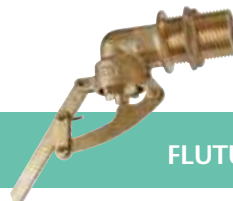

FLUTUADOR COM VARÃO PLANO

Ø		COD.	€
1/2"	50 5	VS91LP03	8,30
3/4"	50 5	VS91LP04	11,35
1"	25 5	VS91LP05	16,45
1 1/4"	10 1	VS91LP06	38,85
1 1/2"	10 1	VS91LP07	48,40
2"	6 1	VS91LP08	81,75



BOIA DE COBRE PARA FLUTUADOR DE VARÃO PLANO

Ø	DIÁMETRO cm		COD.	€
1/2"	12	50 1	VS92CP03	21,95
3/4"	15	24 1	VS92CP04	27,00
1"	17	18 1	VS92CP05	32,45
1 1/4"	20	18 1	VS92CP06	51,15
1 1/2"	23	24 1	VS92CP07	53,10
2"	25	24 1	VS92CP08	64,35

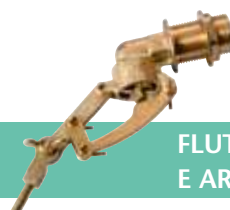

FLUTUADOR COM VARÃO ROSCADO E ARTICULADO

Ø	PORCA VARILLA		COD.	€
1/2"	6/100	50 5	VS91LA03	7,75
3/4"	7/100	50 5	VS91LA04	10,90
1"	8/100	25 5	VS91LA05	16,55



BOIA DE PLÁSTICO ESFÉRICA PARA FLUTUADOR DE VARÃO ROSCADO

Ø	DIÁMETRO cm	PORCA		COD.	€
3/8"	9	3/16	200 1	VS92PE02	1,20
1/2"	11	6/100	110 1	VS92PE03	2,55
3/4"	13	7/100	65 1	VS92PE04	2,90
1"	15	8/100	30 1	VS92PE05	3,80
1 1/4" - 1 1/2"	20	9/100	18 1	VS92PE06	5,90
2"	23	9/100	12 1	VS92PE08	7,75



BOIA DE PLÁSTICO PARA FLUTUADOR MISTA

Ø	DIÁMETRO cm	PORCA		COD.	€
1/2"	12	6/100	120 1	VS92PM03	5,55
3/4"	12	7/100	120 1	VS92PM04	5,55
1"	15	8/100	60 1	VS92PM05	6,60
1 1/4" - 1 1/2"	20	9/100	25 1	VS92PM06	10,05
2"	25	9/100	13 1	VS92PM08	13,95



BORRACHA PARA PISTÃO

Ø		COD.	€
3/8"	10	VS93GP02	0,65
1/2"	10	VS93GP03	0,80
3/4"	10	VS93GP04	0,80
1"	10	VS93GP05	0,90
1 1/4"	10	VS93GP06	0,90
1 1/2"	10	VS93GP07	1,25
2"	10	VS93GP08	1,75



TRAVESSÃO PARA FLUTUADOR

Ø		COD.	€
3/8" y 1/2"	10	VS93PA02	0,20
3/4" y 1"	10	VS93PA04	0,20
1 1/4" y 1 1/2"	10	VS93PA06	0,45
2"	10	VS93PA08	0,95

INSTRUÇÕES DE MONTAGEM

Assegure-se que a válvula é adequada as condições de trabalho: tipo de fluido, pressão e temperatura.

Verifique se a rosca da tubagem está perfeitamente limpa e definida.

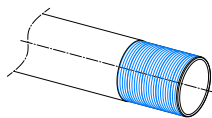

É indispensável a utilização de um vedante (fita teflon ou equivalente) na rosca para obter uma ligação perfeita.

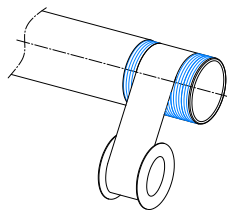

Ter em atenção o alinhamento correto das tubagens, a válvula não absorve as diferenças. As distorções resultantes de um alinhamento incorreto podem causar problemas de estanquidade, dificuldades de manobra e até roturas.

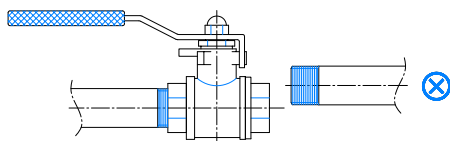

Os tubos devem estar perfeitamente fixos para se aplicar a válvula.

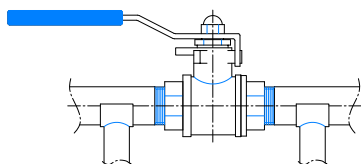

NOTA: O projeto da instalação deve evitar todo o tipo de tensões para não danificar a válvula e mantê-la operacional nas suas funções.

CONSIDERAÇÕES IMPORTANTES

As válvulas de esfera devem permanecer totalmente abertas ou fechadas, a manobra de fecho e abertura deve realizar-se com suavidade para não gerar perturbações bruscas e golpes de ariete.

Deve-se realizar manobras de fecho e abertura aproximadamente a cada 2 meses, sendo este tempo menor se as águas forem duras ou criarem depósito.

Quando a válvula ofereça muita resistência a abertura ou fecho, deve-se manobrar a válvula com um tubo suficientemente grande de modo a prolongar o manípulo.

Nas instalações temporariamente fora de serviço, recomenda-se fechar as ligações e proceder ao seu esvaziamento.

Nunca se deve apertar uma válvula num torno nem se deve usar extensões de chaves, pode provocar deformações ou roturas nas válvulas.

Na união do tubo com a válvula deve usar-se uma chave fixa ou chave inglesa e coloca-la no hexágono do lado que pretendemos apertar. Não utilizar outro tipo de chaves.

Primeiro passo: Deve se manter o tubo fixo e apertar a válvula, colocando uma chave no hexágono do lado a apertar.

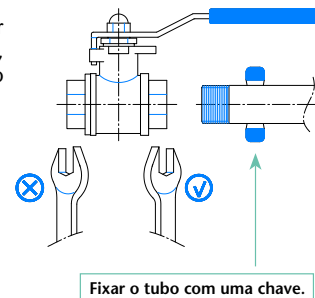

Fixar o tubo com uma chave.

Segundo passo: A válvula matem-se fixa e o tubo é que rosca.

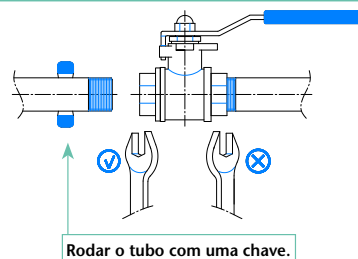

Rodar o tubo com uma chave.

Geralmente não se deve exercer um aperto superior a 30Nm.

Como geralmente o comprimento da rosca do tubo é superior a rosca da válvula, é indispensável para evitar roturas, que o extremo do tubo nunca chegue a tocar o fundo da rosca da válvula. Deve-se salvaguardar pelo menos 1mm de distância.

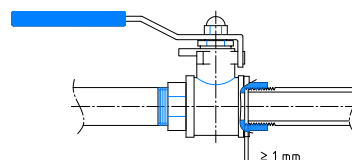

LIGAÇÕES FLÉXIVEIS

DN 8

LIGAÇÕES FLÉXIVEIS DE AÇO INOXIDÁVEL PARA INSTALAÇÕES SANITÁRIAS

- Tubo interior em EPDM – Certificado ACS.
- Revestimento em malha de aço inoxidável AISI 304.
- Casquilho em aço inoxidável AISI 304.
- Acessórios em latão niquelado.
- Junta em EPDM incorporada.
- Cumprem com as normas EN – 13618.
- Certificação AENOR e CSTBat.

- **Diâmetro interior: 8 mm.**
- Diâmetro exterior: 12 mm.
- Diâmetro de passagem: 6 mm.
- Caudal nominal: 30 l./min.
- Raio de curvatura: 30 mm.
- Pressão de serviço: 10 bar.
- Temperatura máxima: 90° C.
- Utilização em água potável.

APLICAÇÕES:

Instalações sanitárias, lavatórios, autoclismos, esquentadores.



F 3/8" - F 3/8"



M 3/8" - F 3/8"

COMPRIM mm.			COD.	€
150	200	5	H1H2H215	1,45
200	100	5	H1H2H220	1,55
250	100	5	H1H2H225	1,55
300	100	5	H1H2H230	1,65
350	100	5	H1H2H235	1,70
400	120	5	H1H2H240	2,00
500	100	5	H1H2H250	2,05
600	100	5	H1H2H260	2,35
800	100	5	H1H2H280	2,80
1000	50	5	H1H2H299	3,35

COMPRIM mm.			COD.	€
150	200	5	H1M2H215	1,45
200	100	5	H1M2H220	1,55
250	100	5	H1M2H225	1,55
300	100	5	H1M2H230	1,65
350	100	5	H1M2H235	1,70
400	120	5	H1M2H240	2,00
500	100	5	H1M2H250	2,05
600	100	5	H1M2H260	2,35
800	100	5	H1M2H280	2,80
1000	50	5	H1M2H299	3,35



F 1/2" - F 1/2"



M 1/2" - F 1/2"

COMPRIM mm.			COD.	€
150	200	5	H1H3H315	1,70
200	100	5	H1H3H320	1,80
250	100	5	H1H3H325	1,85
300	100	5	H1H3H330	1,95
350	100	5	H1H3H335	2,05
400	120	5	H1H3H340	2,15
500	100	5	H1H3H350	2,20
600	100	5	H1H3H360	2,50
800	100	5	H1H3H380	3,10
1000	50	5	H1H3H399	3,45

COMPRIM mm.			COD.	€
150	200	5	H1M3H315	1,70
200	100	5	H1M3H320	1,80
250	100	5	H1M3H325	1,85
300	100	5	H1M3H330	1,95
350	100	5	H1M3H335	2,05
400	120	5	H1M3H340	2,15
500	100	5	H1M3H350	2,20
600	100	5	H1M3H360	2,50
800	100	5	H1M3H380	3,10
1000	50	5	H1M3H399	3,45



F 3/8" - F 1/2"

COMPRIM mm.			COD.	€
150	200	5	H1H2H315	1,70
200	100	5	H1H2H320	1,80
250	100	5	H1H2H325	1,85
300	100	5	H1H2H330	1,95
350	100	5	H1H2H335	2,05
400	120	5	H1H2H340	2,15
500	100	5	H1H2H350	2,20
600	100	5	H1H2H360	2,50
800	100	5	H1H2H380	3,10
1000	50	5	H1H2H399	3,45



M 1/2" - F 3/8"

COMPRIM mm.			COD.	€
150	200	5	H1M3H215	1,70
200	100	5	H1M3H220	1,80
250	100	5	H1M3H225	1,85
300	100	5	H1M3H230	1,95
350	100	5	H1M3H235	2,05
400	120	5	H1M3H240	2,15
500	100	5	H1M3H250	2,20
600	100	5	H1M3H260	2,50
800	100	5	H1M3H280	3,10
1000	50	5	H1M3H299	3,45



M 3/8" - F 1/2"

COMPRIM mm.			COD.	€
150	200	5	H1M2H315	1,70
200	100	5	H1M2H320	1,80
250	100	5	H1M2H325	1,85
300	100	5	H1M2H330	1,95
350	100	5	H1M2H335	2,05
400	120	5	H1M2H340	2,15
500	100	5	H1M2H350	2,20
600	100	5	H1M2H360	2,50
800	100	5	H1M2H380	3,10
1000	50	5	H1M2H399	3,45



F 3/8" - M 10x1 L17

COMPRIM mm.			COD.	€
300	100	5	H1H21130	2,35
400	120	5	H1H21140	2,55
500	100	5	H1H21150	2,75

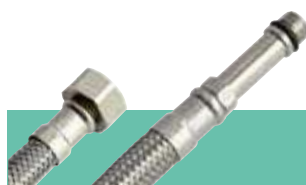

F 3/8" - M 10x1 L37

COMPRIM mm.			COD.	€
300	100	5	H1H21330	2,65
400	120	5	H1H21340	2,85
500	100	5	H1H21350	3,10

DN 13

LIGAÇÕES FLEXÍVEIS DE AÇO INOXIDÁVEL PARA CLIMATIZAÇÃO E AR CONDICIONADO

- Tubo interior em EPDM – Certificado ACS.
- Revestimento em malha de aço inoxidável AISI 304.
- Casquilho em aço inoxidável AISI 304.
- Acessórios em latão niquelado.
- Junta em EPDM incorporada.
- Cumprem com as normas EN – 13618.
- Certificação CSTBat.
- **Diâmetro interior: 13 mm.**
- Diâmetro exterior: 17 mm.
- Diâmetro de passagem: 10 mm.
- Caudal nominal: 70 l./min.
- Raio de curvatura: 45 mm.
- Pressão de serviço: 10 bar.
- Temperatura máxima: 90° C.
- Utilização em água potável

APLICAÇÕES:

Caldeiras, esquentadores, acumuladores, cilindros, painéis solares, ar condicionado e maquinas de lavar.



F 1/2" - F 1/2"

COMPRIM mm.			COD.	€
200	60	5	H2H3H320	3,25
250	50	5	H2H3H325	3,50
300	60	5	H2H3H330	3,75
350	50	5	H2H3H335	4,00
400	70	5	H2H3H340	4,35
500	50	5	H2H3H350	4,85
600	50	5	H2H3H360	5,30
800	50	5	H2H3H380	6,40
1000	50	5	H2H3H399	7,35

M 1/2" - F 1/2"

COMPRIM mm.			COD.	€
200	60	5	H2M3H320	3,25
250	50	5	H2M3H325	3,50
300	60	5	H2M3H330	3,75
350	50	5	H2M3H335	4,00
400	70	5	H2M3H340	4,35
500	50	5	H2M3H350	4,85
600	50	5	H2M3H360	5,30
800	50	5	H2M3H380	6,40
1000	50	5	H2M3H399	7,35

F 3/4" - F 3/4"

COMPRIM mm.			COD.	€
200	50	5	H2H4H420	3,70
250	50	5	H2H4H425	3,95
300	60	5	H2H4H430	4,25
350	50	5	H2H4H435	4,45
400	60	5	H2H4H440	4,75
500	50	5	H2H4H450	5,25
600	50	5	H2H4H460	5,80
800	50	5	H2H4H480	6,75
1000	50	5	H2H4H499	7,80

M 3/4" - F 3/4"

COMPRIM mm.			COD.	€
200	50	5	H2M4H420	3,70
250	50	5	H2M4H425	3,95
300	60	5	H2M4H430	4,25
350	50	5	H2M4H435	4,45
400	60	5	H2M4H440	4,75
500	50	5	H2M4H450	5,25
600	50	5	H2M4H460	5,80
800	50	5	H2M4H480	6,75
1000	50	5	H2M4H499	7,80

F 1/2" - F 3/4"

COMPRIM mm.			COD.	€
250	50	5	H2H3H425	3,95
300	60	5	H2H3H430	4,25
350	50	5	H2H3H435	4,45
400	60	5	H2H3H440	4,75
500	50	5	H2H3H450	5,25

M 1/2" - F 3/4"

COMPRIM mm.			COD.	€
250	50	5	H2M3H425	3,95
300	60	5	H2M3H430	4,25
350	50	5	H2M3H435	4,45
400	60	5	H2M3H440	4,75
500	50	5	H2M3H450	5,25

DN 19-50

LIGAÇÕES FLEXÍVEIS DE AÇO INOXIDÁVEL PARA BATERIAS DE CONTADOR E GRUPOS DE PRESSÃO

- Tubo interior em EPDM – Certificado ACS.
- Revestimento em malha de aço inoxidável AISI 304.
- Casquilho em aço inoxidável AISI 304 (3/4" e 1")
- Casquilho em alumínio (1 1/4" a 2")
- Acessórios em latão.
- Junta em EPDM incorporada.
- **Pressão de serviço: 16 bar.**
- Temperatura máxima: 90° C.
- Utilização em água potável.

APLICAÇÕES:

Baterias de contador, grupos de pressão, bombas de água, climatização e aplicações industriais



M 3/4" - F 3/4"

CARACTERÍSTICAS	COMPRIM mm.		COD.	€
Diâmetro interior: 19 mm. Diâmetro Exterior: 27 mm. Diâmetro de passagem: 15 mm. Caudal nominal: 120 l./min. Raio de curvatura: 80 mm.	300	25 5	H3M4H430	7,20
	400	25 5	H3M4H440	8,10
	500	25 5	H3M4H450	8,35
	600	25 5	H3M4H460	9,45
	800	25 5	H3M4H480	12,45
	1000	25 5	H3M4H499	14,65



F 3/4" - F 3/4"

CARACTERÍSTICAS	COMPRIM mm.		COD.	€
Diâmetro interior: 19 mm. Diâmetro Exterior: 27 mm. Diâmetro de passagem: 15 mm. Caudal nominal: 120 l./min. Raio de curvatura: 80 mm.	300	25 5	H3H4H430	7,20
	400	25 5	H3H4H440	8,10
	500	25 5	H3H4H450	8,35
	600	25 5	H3H4H460	9,45
	800	25 5	H3H4H480	12,45
	1000	25 5	H3H4H499	14,65



M 1" - F 1"

CARACTERÍSTICAS	COMPRIM mm.		COD.	€
Diâmetro interior: 25 mm. Diâmetro Exterior: 33 mm. Diâmetro de passagem: 20 mm. Caudal nominal: 200 l./min. Raio de curvatura: 100 mm.	300	25 5	H3M5H530	11,85
	400	25 5	H3M5H540	13,25
	500	25 5	H3M5H550	13,90
	600	15 5	H3M5H560	15,00
	800	15 5	H3M5H580	19,05
	1000	10 5	H3M5H599	23,70



F 1" - F 1"

CARACTERÍSTICAS	COMPRIM mm.		COD.	€
Diâmetro interior: 25 mm. Diâmetro Exterior: 33 mm. Diâmetro de passagem: 20 mm. Caudal nominal: 200 l./min. Raio de curvatura: 100 mm.	300	25 5	H3H5H530	11,85
	400	25 5	H3H5H540	13,25
	500	25 5	H3H5H550	13,90
	600	15 5	H3H5H560	15,00
	800	15 5	H3H5H580	19,05
	1000	10 5	H3H5H599	23,70



M 1 1/4" - F 1 1/4"

CARACTERÍSTICAS	COMPRIM mm.		COD.	€
Diâmetro interior: 30 mm. Diâmetro Exterior: 43 mm. Diâmetro de passagem: 25 mm. Caudal nominal: 400 l./min. Raio de curvatura: 190 mm.	300	15 5	H3M6H630	21,00
	400	10 5	H3M6H640	24,50
	500	10 5	H3M6H650	28,00
	600	10 5	H3M6H660	31,40
	800	10 5	H3M6H680	38,45
	1000	10 5	H3M6H699	45,45



F 1 1/4" - F 1 1/4"

CARACTERÍSTICAS	COMPRIM mm.		COD.	€
Diâmetro interior: 30 mm. Diâmetro exterior: 43 mm. Diâmetro de passagem: 25 mm. Caudal nominal: 400 l./min. Raio de curvatura: 190 mm.	300	15 5	H3H6H630	21,00
	400	10 5	H3H6H640	24,50
	500	10 5	H3H6H650	28,00
	600	10 5	H3H6H660	31,40
	800	10 5	H3H6H680	38,45
	1000	10 5	H3H6H699	45,45



M 1 1/2" - F 1 1/2"

CARACTERÍSTICAS	COMPRIM mm.		COD.	€
Diâmetro interior: 40 mm.	300	15 5	H3M7H730	33,10
Diâmetro Exterior: 53 mm.	400	10 5	H3M7H740	37,90
Diâmetro de passagem: 32 mm.	500	10 5	H3M7H750	42,70
Caudal nominal: 700 l./min.	600	5 5	H3M7H760	47,40
Raio de curvatura: 230 mm.	800	5 5	H3M7H780	57,10
	1000	5 5	H3M7H799	66,45

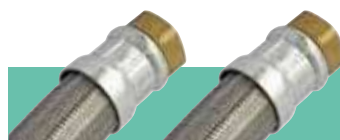

F 1 1/2" - F 1 1/2"

CARACTERÍSTICAS	COMPRIM mm.		COD.	€
Diâmetro interior: 40 mm.	300	15 5	H3H7H730	33,10
Diâmetro exterior: 53 mm.	400	10 5	H3H7H740	37,90
Diâmetro de passagem: 32 mm.	500	10 5	H3H7H750	42,70
Caudal nominal: 700 l./min.	600	5 5	H3H7H760	47,40
Raio de curvatura: 230 mm.	800	5 5	H3H7H780	57,10
	1000	5 5	H3H7H799	66,45

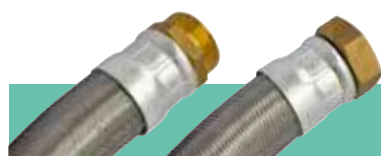

M 2" - F 2"

CARACTERÍSTICAS	COMPRIM mm.		COD.	€
Diâmetro interior: 50 mm.	300	10 5	H3M8H830	52,80
Diâmetro Exterior: 63 mm.	400	10 5	H3M8H840	58,85
Diâmetro de passagem: 40 mm.	500	10 5	H3M8H850	65,00
Caudal nominal: 1050 l./min.	600	5 5	H3M8H860	71,25
Raio de curvatura: 300 mm.	800	5 5	H3M8H880	83,55
	1000	5 5	H3M8H899	95,30

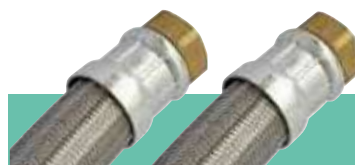

F 2" - F 2"

CARACTERÍSTICAS	COMPRIM mm.		COD.	€
Diâmetro interior: 50 mm.	300	10 5	H3H8H830	52,80
Diâmetro Exterior: 63 mm.	400	10 5	H3H8H840	58,85
Diâmetro de passagem: 40 mm.	500	10 5	H3H8H850	65,00
Caudal nominal: 1050 l./min.	600	5 5	H3H8H860	71,25
Raio de curvatura: 300 mm.	800	5 5	H3H8H880	83,55
	1000	5 5	H3H8H899	95,30



M 1" - CURVA F 1"

CARACTERÍSTICAS	COMPRIM mm.		COD.	€
Diâmetro interior: 25 mm.	600	15 5	H3M5C560	19,40
Diâmetro Exterior: 33 mm.	800	15 5	H3M5C580	21,80
Diâmetro de passagem: 20 mm.				
Caudal nominal: 200 l./min.				
Raio de curvatura: 100 mm.				



M 1 1/4" - CURVA F 1 1/4"

CARACTERÍSTICAS	COMPRIM mm.		COD.	€
Diâmetro interior: 30 mm.	600	10 5	H3M6C660	37,95
Diâmetro Exterior: 43 mm.	800	10 5	H3M6C680	41,90
Diâmetro de passagem: 25 mm.				
Caudal nominal: 400 l./min.				
Raio de curvatura: 190 mm.				



JUNTAS EM EPDM PARA LIGAÇÕES FLÉXIVEIS

Ø		COD.	€
3/8"	50	HJ000002	0,06
1/2" - DN 8	50	HJ000003	0,07
1/2" - DN 13	50	HJ000033	0,07
3/4"	50	HJ000004	0,09
1"	50	HJ000005	0,13
1 1/4"	10	HJ000006	0,24
1 1/2"	10	HJ000007	0,28
2"	10	HJ000008	0,35

COMPONENTES

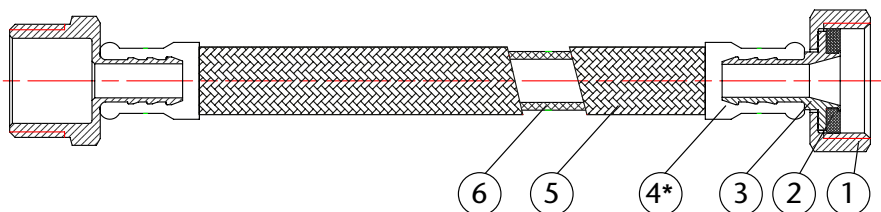

1. Latão niquelado.
2. Junta EPDM.
3. Latão.
4. Aço inoxidável AISI 304
*Alumínio para medidas de 1 1/4" a 2".
5. Aço inoxidável AISI 304.
6. EPDM.

RECOMENDAÇÕES DE INSTALAÇÃO

Antes de utilizar a ligação deve verificar que o produto está conforme.

As ligações devem ser instaladas a vista. Não devem atravessar paredes.

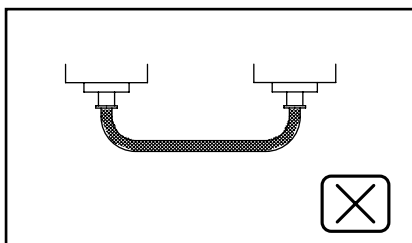
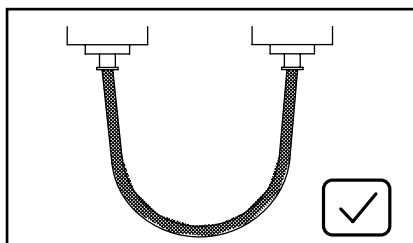

Respeite o raio da curvatura mínimo estabelecido para cada diâmetro.

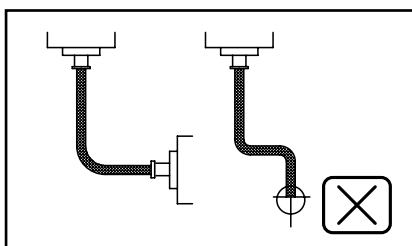
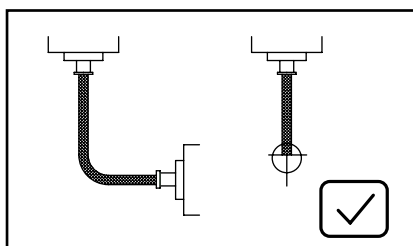

Assegure-se que a ligação não está submetida a torsão.

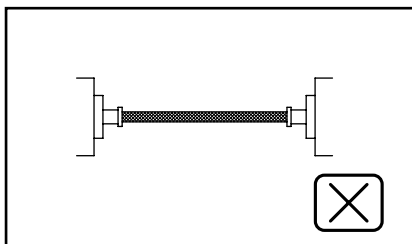
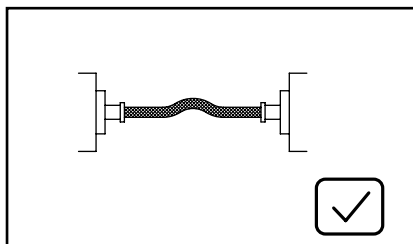

Utilize um comprimento superior para evitar tensões.

A responsabilidade do fabricante está excluída no caso de não se respeitar as recomendações de instalação.

SISTEMAS DE **FIXAÇÃO**

Os sistemas de fixação SYC são uma família de produtos considerada como um complemento importante dentro do catálogo da ATUSA.

Dentro desta família estamos a implementar uma gama cada vez mais variada – abraçadeiras metálicas, isofónicas, reforçadas, PVC, fixação para sanitários-

Incluimos abraçadeiras que criem soluções de suporte para qualquer tipo de tubagem, quer sejam verticais, horizontais ou suspensas.



SISTEMAS DE
FIXAÇÃO

ABRAÇADEIRAS METÁLICAS LIGEIRAS



ABRAÇADEIRA M6

Abertura de um dos lados para uma montagem mais rápida, Bicromado.

Ø mm.	PULGADAS		COD.	€ 100 UDS.
12	1/4"	1.000 100	RFSM0012	15,40
15	-	1.000 100	RFSM0015	16,50
16	-	1.000 100	RFSM0016	16,50
18	3/8"	1.000 100	RFSM0018	17,60
20	-	1.000 100	RFSM0020	17,60
22	1/2"	1.000 100	RFSM0022	18,70
26	3/4"	1.000 100	RFSM0026	19,80
28	-	1.000 100	RFSM0028	20,90
32	1"	500 50	RFSM0032	22,00
35	-	500 50	RFSM0035	23,10
40	-	500 50	RFSM0040	28,60
42	1 1/4"	500 50	RFSM0042	33,00
50	-	500 50	RFSM0050	33,00
63	-	250 50	RFSM0063	48,40



ABRAÇADEIRA M6 COM PARAFUSO

Abertura de um dos lados para uma montagem mais rápida, Bicromado.

Ø mm.	PULGADAS		COD.	€ 100 UDS.
12	1/4"	1.000 100	RFSMT012	19,95
15	-	1.000 100	RFSMT015	19,95
18	3/8"	1.000 100	RFSMT018	19,95
20	-	1.000 100	RFSMT020	21,00
22	1/2"	1.000 100	RFSMT022	22,05
24	-	1.000 100	RFSMT024	22,05
26	3/4"	1.000 100	RFSMT026	23,10
28	-	1.000 100	RFSMT028	25,20
32	1"	500 50	RFSMT032	25,20
35	-	500 50	RFSMT035	28,35
40	-	500 50	RFSMT040	31,50
42	1 1/4"	500 50	RFSMT042	35,70
50	-	500 50	RFSMT050	36,75



ABRAÇADEIRA DUPLA M6

Bicromado

Ø mm.	PULGADAS		COD.	€ 100 UDS.
12	1/8"	500 50	RFDM0012	25,30
14-15	1/4"	500 50	RFDM0014	27,60
18	3/8"	500 50	RFDM0018	31,05
22	1/2"	500 50	RFDM0022	34,50
28	3/4"	500 50	RFDM0028 (1)	49,45



ABRAÇADEIRA "GÁS" NEGRA M6 COM PARAFUSO

Abertura de um dos lados para uma montagem mais rápida, acabamento a negro de alta resistência.

Ø mm.	PULGADAS		COD.	€ 100 UDS.
15	3/8"	1.000 100	RFSRN015	28,35
18	-	1.000 100	RFSRN018	30,45
22	-	1.000 100	RFSRN022	31,50
28	3/4"	1.000 100	RFSRN028	34,65



ABRAÇADEIRA DUPLA M6 COM PARAFUSO

Bicromado

Ø mm.	PULGADAS		COD.	€ 100 UDS.
12	1/8"	500 50	RFDMT012	34,50
14	1/4"	500 50	RFDMT014	36,80
18	3/8"	500 50	RFDMT018	40,25
22	1/2"	500 50	RFDMT022	41,40
28	3/4"	500 50	RFDMT028	58,65

(1) Até fim de existências



ABRAÇADEIRA ISOFÓNICA M6

Abertura de um dos lados para uma montagem mais rápida, bicromada. Anel em borracha para isolamento e insonorização.

Ø mm.	PULGADAS		COD.	€ 100 UDS.
12	1/4"	1.000 100	RFSG0012	25,20
14-15	-	1.000 100	RFSG0014	27,30
18	-	1.000 100	RFSG0018	30,45
20	1/2"	1.000 100	RFSG0020	32,55
22	-	1.000 100	RFSG0022	32,55
26	3/4"	500 100	RFSG0026	36,75
28	-	500 100	RFSG0028	39,90
32	1"	500 50	RFSG0032	45,15
35	-	500 50	RFSG0035	50,40
42	1 1/4"	500 50	RFSG0042	58,80



ABRAÇADEIRA "SEM FIM"

Fita com bordos e levantados e arredondados para a proteção do tubo / mangueira. Uso industrial, agrícola e doméstico.

Ø mm.	PULGADAS		COD.	€ 100 UDS.
10	10-16	1.000 100	RFSF0010	32,55
12	12-20	1.000 100	RFSF0012	33,60
15	16-25	1.000 100	RFSF0015	33,60
20	20-32	1.000 100	RFSF0020	34,65
25	25-40	500 100	RFSF0025	36,75
32	32-50	500 100	RFSF0032	39,90
40	40-60	500 50	RFSF0040	42,00
50	50-70	250 50	RFSF0050	45,15
60	60-80	250 50	RFSF0060	47,25
70	70-90	250 50	RFSF0070	50,40
80	80-100	250 25	RFSF0080	54,60
90	90-110	125 25	RFSF0090	59,85
100	100-120	125 25	RFSF0100	64,05
120	120-140	50 25	RFSF0120	70,35
140	140-160	50 25	RFSF0140	77,70



GRAMPO SIMPLES

Aço zincado. Para cabos, tubos de aço e PVC.

Ø mm.	PULGADAS		COD.	€ 100 UDS.
8	-	2.000 100	RFGA0008	5,75
10	1/8"	2.000 100	RFGA0010	6,90
12	1/4"	2.000 100	RFGA0012	6,90
15	-	2.000 100	RFGA0015	10,00
16	3/8"	1.000 100	RFGA0016	10,35
18	-	1.000 100	RFGA0018	12,65
20	1/2"	1.000 100	RFGA0020	13,80
22	-	1.000 100	RFGA0022	14,95
26	3/4"	1.000 100	RFGA0026	16,10
32	1"	1.000 100	RFGA0032	19,55
40	-	500 50	RFGA0040	32,20



GRAMPO PONTE

Aço zincado. Para cabos, tubos de aço e PVC.

Ø mm.	PULGADAS		COD.	€ 100 UDS.
8	-	2.000 100	RFGAP008	6,60
10	1/8"	2.000 100	RFGAP010	6,60
12	1/4"	2.000 100	RFGAP012	7,70
15	-	1.000 100	RFGAP015	11,00
16	3/8"	1.000 100	RFGAP016	11,30
18	-	1.000 100	RFGAP018	14,30
20	1/2"	1.000 100	RFGAP020	15,40
22	-	1.000 100	RFGAP022	16,50
24	-	1.000 100	RFGAP024	16,50
26	3/4"	1.000 100	RFGAP026	17,60
30	-	500 50	RFGAP030	19,80
32	1"	500 50	RFGAP032	23,10
40	-	500 50	RFGAP040	35,20

ABRAÇADEIRAS METÁLICAS REFORÇADAS

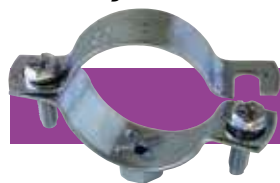

ABRAÇADEIRA ABERTA M8

Abertura de um dos lados para uma montagem mais rápida.
Para instalações horizontais, verticais e suspensas.

Ø	mm.	PULGADAS		COD.	€ 100 UDS.
22	20-24	1/2"	500 100	RFRM0022	60,00
28	25-28	3/4"	250 50	RFRM0028	61,60
35	32-36	1"	250 50	RFRM0035	66,00
42	40-43	1 1/4"	250 25	RFRM0042	68,20
48	47-50	1 1/2"	250 25	RFRM0048	73,70
54	50-54	-	250 25	RFRM0054	78,10
60	59-63	2"	125 25	RFRM0060	82,50
75	75-80	2 1/2"	100 20	RFRM0075	93,50
90	87-92	3"	90 18	RFRM0090	104,50
110	107-112	-	30 15	RFRM0110	121,00
115	113-118	4"	30 15	RFRM0115	132,00
125	125-130	-	30 15	RFRM0125	137,50



ABRAÇADEIRA ISOFÓNICA ABERTA M8

Abertura de um dos lados para uma montagem mais rápida.
Anel em borracha para isolamento e insonorização.
Para instalações horizontais, verticais e suspensas.

Ø	mm.	PULGADAS		COD.	€ 100 UDS.
15	12-16	1/4"	500 50	RFRG0015	68,25
18	17-19	3/8"	250 50	RFRG0018	70,35
22	20-24	1/2"	250 50	RFRG0022	74,55
28	25-28	3/4"	250 25	RFRG0028	81,90
35	32-36	1"	250 25	RFRG0035	90,30
42	40-43	1 1/4"	125 25	RFRG0042	98,70
48	47-50	1 1/2"	100 20	RFRG0048	105,00
54	50-54	-	100 20	RFRG0054	115,50
60	59-63	2"	100 20	RFRG0060	120,75
75	75-80	2 1/2"	40 20	RFRG0075	136,50
90	87-92	3"	40 20	RFRG0090	152,25
110	107-112	-	25 -	RFRG0110	189,00
115	113-118	4"	20 -	RFRG0115	199,50
125	125-130	-	20 -	RFRG0125	215,25



ABRAÇADEIRA M8/M10

Para instalações horizontais, verticais e suspensas.

Ø	mm.	PULGADAS		COD.	€ 100 UDS.
22	20-25	1/2"	500 50	RFRMD022	71,40
28	26-30	3/4"	500 50	RFRMD028	76,65
35	32-36	1"	250 50	RFRMD035	80,85
40	38-43	1 1/4"	250 25	RFRMD040	86,10
48	47-51	1 1/2"	250 25	RFRMD048	92,40
54	53-56	-	125 25	RFRMD054	98,70
60	60-64	2"	125 25	RFRMD060	103,95
75	75-80	2 1/2"	100 20	RFRMD075	115,50
90	87-92	3"	80 16	RFRMD090	126,00
110	107-112	-	50 10	RFRMD110	183,75
115	113-118	4"	25 -	RFRMD115	194,25
125	125-130	-	25 -	RFRMD125	204,75
140	138-142	5"	25 -	RFRMD140	215,25
160	159-166	6"	25 -	RFRMD160	236,25
200	200-212	-	25 -	RFRMD200	278,25
250	249-254	-	20 -	RFRMD250	330,75
315	312-318	-	20 -	RFRMD315	346,50



ABRAÇADEIRA ISOFÓNICA M8/M10

Anel em borracha para isolamento e insonorização.
Para instalações horizontais, verticais e suspensas.

Ø	mm.	PULGADAS		COD.	€ 100 UDS.
18	15-19	3/8"	250 50	RFRGD018	88,20
22	20-25	1/2"	250 50	RFRGD022	91,35
28	26-30	3/4"	250 25	RFRGD028	96,60
35	32-36	1"	250 25	RFRGD035	105,00
40	38-43	1 1/4"	125 25	RFRGD040	115,50
48	47-51	1 1/2"	100 20	RFRGD048	126,00
54	53-56	-	100 20	RFRGD054	136,50
60	60-64	2"	100 20	RFRGD060	141,75
75	75-80	2 1/2"	50 25	RFRGD075	162,75
90	87-92	3"	40 20	RFRGD090	183,75
110	107-112	-	25 -	RFRGD110	278,25
115	113-118	4"	20 -	RFRGD115	288,75
125	125-130	-	20 -	RFRGD125	304,50
140	138-142	5"	15 -	RFRGD140	330,75
160	159-166	6"	15 -	RFRGD160	367,50
200	200-212	-	20 -	RFRGD200	430,50
250	248-252	-	15 -	RFRGD250	525,00



**ABRAÇADEIRA "PREMIUM"
M8/M10**

Parafuso anti - perda. Soldadura da porca por pontos.

POLEGADAS	mm.	TUERCA		COD.	€ 100 UDS.
3/8"	16-18	M8	150 2	RAF35102	82,95
1/2"	20-22	M8	150 2	RAF35103	89,25
3/4"	25-28	M8	150 2	RAF35104	94,50
1"	31-34	M8	150 2	RAF35105	99,75
1 1/4"	39-43	M8	100 2	RAF35106	110,25
1 1/2"	45-48.5	M8	100 2	RAF35107	115,50
2"	58-61	M8	100 2	RAF35108	126,00
2 1/2"	73-76.5	M10	80 2	RAF3510A	178,50
3"	86-89	M10	60 2	RAF3510B	204,75
4"	110-115	M10	40 2	RAF3510C	236,25



**ABRAÇADEIRA "PREMIUM"
M8/M10 COM BUCHA E PARAFUSO**

Parafuso anti - perda. Soldadura da porca por pontos.

POLG.	mm.	PARAFUSO	BUCHA		COD.	€ 100 UDS.
3/8"	16-18	M8x100	10x50	150 2	RAF35502	136,50
1/2"	20-22	M8x100	10x50	150 2	RAF35503	141,75
3/4"	25-28	M8x100	10x50	150 2	RAF35504	152,25
1"	31-34	M8x100	10x50	100 2	RAF35505	162,75
1 1/4"	39-43	M8x100	10x50	100 2	RAF35506	178,50
1 1/2"	45-48.5	M8x100	10x50	100 2	RAF35507	183,75
2"	58-61	M8x100	10x50	100 2	RAF35508	199,50
2 1/2"	73-76.5	M10x120	12x60	80 2	RAF3550A	246,75
3"	86-89	M10x120	12x60	60 2	RAF3550B	267,75
4"	110-115	M10x120	12x60	40 2	RAF3550C	346,50



**ABRAÇADEIRA ISOFÓNICA
"PREMIUM" M8/M10**

Parafuso anti - perda. Soldadura da porca por pontos. Borracha em EPDM vulcanizada.

POLEGADAS	mm.	TUERCA		COD.	€ 100 UDS.
3/8"	17-19	M8	100 2	RAF351G2	252,00
1/2"	21-23	M8	100 2	RAF351G3	262,50
3/4"	26.5-28	M8	100 2	RAF351G4	283,50
1"	33-35	M8	80 2	RAF351G5	325,50
1 1/4"	42-45	M8	60 2	RAF351G6	378,00
1 1/2"	48-50	M8	60 2	RAF351G7	425,25
2"	60-64	M8	40 2	RAF351G8	509,25
2 1/2"	73-80	M10	40 2	RAF351GA	740,25
3"	87-91	M10	40 2	RAF351GB	808,50
4"	108-116	M10	20 2	RAF351GC	939,75



**ABRAÇADEIRA ISOFÓNICA "PREMIUM"
M8/M10 COM BUCHA E PARAFUSO**

Parafuso anti - perda. Soldadura da porca por pontos. Borracha em EPDM vulcanizada.

POLG.	mm.	PARAFUSO	BUCHA		COD.	€ 100 UDS.
3/8"	17-19	M8x100	10x50	100 2	RAF355G2	273,00
1/2"	21-23	M8x100	10x50	100 2	RAF355G3	283,50
3/4"	26.5-28	M8x100	10x50	80 2	RAF355G4	299,25
1"	33-35	M8x100	10x50	80 2	RAF355G5	351,75
1 1/4"	42-45	M8x100	10x50	60 2	RAF355G6	399,00
1 1/2"	48-50	M8x100	10x50	60 2	RAF355G7	451,50
2"	60-64	M8x100	10x50	40 2	RAF355G8	561,75
2 1/2"	71-80	M10x120	12x60	30 2	RAF355GA	750,75
3"	87-91	M10x120	12x60	30 2	RAF355GB	834,75
4"	108-116	M10x120	12x60	20 2	RAF355GC	950,25



ABRAÇADEIRA "EXTRA"

Fita com rebordos levantados e arredondados para a proteção do tubo / mangueira. Uso industrial, agrícola e doméstico.

Ø	mm.	TUERCA		COD.	€ 100 UDS.
17	17-19	M5	1.000 100	RFS00017	94,50
20	20-22	M5	1.000 100	RFS00020	95,55
23	23-25	M5	500 100	RFS00023	96,60
25	25-27	M5	500 100	RFS00025	97,65
26	26-28	M5	500 100	RFS00026	98,70
29	29-31	M6	250 50	RFS00029	115,50
32	32-35	M6	250 50	RFS00032	120,75
36	36-39	M6	250 50	RFS00036	120,75
40	40-43	M6	250 50	RFS00040	126,00
44	44-47	M6	125 25	RFS00044	147,00
48	48-51	M6	125 25	RFS00048	147,00
52	52-55	M6	125 25	RFS00052	152,25
56	56-59	M6	100 20	RFS00056	162,75
60	60-63	M6	100 20	RFS00060	162,75
64	64-67	M8	100 20	RFS00064	168,00
68	68-73	M8	75 15	RFS00068	225,75
74	74-79	M8	75 15	RFS00074	236,25
80	80-85	M8	75 15	RFS00080	236,25
86	86-91	M8	50 10	RFS00086	241,50
92	92-97	M8	50 10	RFS00092	252,00
98	98-103	M8	50 -	RFS00098	252,00
104	104-112	M8	40 -	RFS00104	262,50
113	113-121	M8	25 -	RFS00113	273,00
122	122-130	M8	25 -	RFS00122	283,50
131	131-139	M10	25 -	RFS00131	383,25
140	140-148	M10	25 -	RFS00140	393,75
149	149-161	M10	20 -	RFS00149	404,25
162	162-174	M10	20 -	RFS00162	420,00
201	201-213	M10	14 -	RFS00201	472,50
214	214-226	M10	14 -	RFS00214	495,00
240	240-252	M10	12 -	RFS00240	540,75



ABRAÇADEIRA PARA TUBO DE ESGOTO

Para redes de esgoto.

Ø	mm.		COD.	€ 100 UDS.
75	75-80	200 20	RFDES075	126,00
90	82-90	100 20	RFDES090	131,25
110	106-112	100 20	RFDES110	141,75
125	124-130	75 15	RFDES125	152,25
160	159-165	64 32	RFDES160	278,25
200	199-212	50 25	RFDES200	325,50



ABRAÇADEIRA PENDENTE "PÊRA"

Tubagens suspensas, especialmente redes contra incêndios.

Ø	POLEGADAS	TUERCA		COD.	€ 100 UDS.
35	1"	M8	200 100	RFP00035	115,50
40	1 1/4"	M8	100 50	RFP00040	120,75
48	1 1/2"	M8	100 50	RFP00048	131,25
60	2"	M8	80 40	RFP00060	141,75
75	2 1/2"	M10	60 30	RFP00075	215,25
90	3"	M10	40 20	RFP00090	231,00
115	4"	M10	20 10	RFP00115	283,50



ABRAÇADEIRA "GÁS" AMARELA M8/M10

Pela sua cor amarela é especialmente utilizada para tubagens de gás.

Ø	mm.	POLG.	PORCA		COD.	€ 100 UDS.
22	20-24	1/2"	M8	500 100	RFRR0022	107,00
28	26-30	3/4"	M8	500 50	RFRR0028	110,25
35	32-36	1"	M8	250 50	RFRR0035	115,50
40	38-42	1 1/4"	M8	250 25	RFRR0040	120,75
48	47-50	1 1/2"	M8	250 25	RFRR0048	131,25
60	60-64	2"	M8	125 25	RFRR0060	152,25
75	75-80	2 1/2"	M10	100 20	RFRR0075	178,50
90	82-90	3"	M10	90 18	RFRR0090	204,75
115	114-119	4"	M10	30 15	RFRR0115	252,00



ABRAÇADEIRA EM "U"

As abraçadeiras M6 e M8 são fornecidas com porcas e anilhas. Aço zincado.

Ø Tubo	POLG.	PORCA		COD.	€ 100 UDS.
17,1	3/8"	M6	1200 200	RFAB0002	24,15
21,3	1/2"	M6	1200 200	RFAB0003	25,30
26,9	3/4"	M6	900 150	RFAB0004	27,60
33,7	1"	M6	750 125	RFAB0005	33,35
42,4	1 1/4"	M6	600 100	RFAB0006	35,65
48,3	1 1/2"	M8	300 50	RFAB0007	67,85
60,3	2"	M8	300 50	RFAB0008	74,75
76,1	2 1/2"	M8	150 25	RFAB000A	149,50
88,9	3"	M8	125 25	RFAB000B	166,75
101,6	3 1/2"	M10	120 20	RFAB000C	172,50
114,3	4"	M10	100 20	RFAB000D	195,50
139,7	5"	M10	100 20	RFAB000E	224,25
168,3	6"	M10	75 15	RFAB000F	258,75
219,1	8"	M10	50 10	RFAB000H	350,75
273,0	10"	M10	10 -	RFAB000J	373,75
323,9	12"	M14	10 -	RFAB000L	1.081,00
355,6	14"	M14	10 -	RFAB000N	1.178,75

FIXAÇÕES PARA SANITÁRIOS



KIT DE FIXAÇÃO PARA LAVATÓRIO (2 un.)

Conjunto de bucha de nylon + parafuso de dupla rosca.

PARAFUSO	BUCHA			COD.	€ KIT
M8x110	10x50	150	15	RFFL0811	1,10
M10x120	12x60	150	15	RFFL1012	1,60



KIT DE FIXAÇÃO PARA SANITÁRIOS SUSPENSOS (2 un.)

Conjunto de bucha de nylon + parafuso de dupla rosca.

PARAFUSO	BUCHA			COD.	€ KIT
M8x110	10x50	150	15	RFFP0811	1,05
M10x120	12x60	150	15	RFFP1012	1,45



KIT FIXAÇÃO PARA SANITA E BIDÉ (2 un.)

Conjunto de bucha de nylon + parafuso de dupla rosca.

	PARAFUSO	BUCHA			COD.	€ KIT
INOX.	M5x75	8x40	250	25	RFFWIS75	1,80
LATON	M5x75	8x40	250	25	RFFWLS75	3,15



KIT DE FIXAÇÃO PARA ESQUENTADORES (2 un.)

Conjunto de bucha de nylon + Escápula

PARAFUSO	BUCHA			COD.	€ KIT
M8x65	10x50	250	25	RFFC0865	0,80
M10x75	12x60	250	25	RFFC1075	1,15

BUCHAS, PARAFUSOS E ACESSÓRIOS



PARAFUSO PORCA DUPLA M8/M10

PORCA	mm.			COD.	€ 100 UDS.
M8	50	1.000	100	RFTD0850	14,95
M8	80	1.000	100	RFTD0880	19,55
M8	100	600	100	RFTD8100	24,15
M8	120	600	100	RFTD8120	31,05
M10	80	1.000	100	RFTD1080	31,05
M10	100	1.000	100	RFTD1010	41,40



PARAFUSO PARA ABRAÇADEIRA M6/M8

PORCA	mm.			COD.	€ 100 UDS.
M6	30	2.000	100	RFTR0630	5,00
M6	40	2.000	100	RFTR0640	6,90
M6	50	2.000	100	RFTR0650	6,90
M8	40	2.000	100	RFTR0840	11,50
M8	60	2.000	100	RFTR0860	14,95

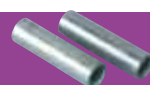

UNIÃO REDONDO

Para união ou prolongamento de fixações standard.

PORCA	COMPRIM			COD.	€ 100 UDS.
M6	20	1.500	150	RFMR0620	15,75
M6	30	1.500	150	RFMR0630	22,05
M8	20	1.000	100	RFMR0820	22,05
M8	30	1.000	100	RFMR0830	26,25
M10	30	500	50	RFMR1030	29,40



UNIÃO HEXAGONAL

Para união ou prolongamento de fixações standard.

PORCA	COMPRIM			COD.	€ 100 UDS.
M6	20	1.500	150	RFMH0620	19,80
M6	30	1.500	150	RFMH0630	26,40
M8	20	1.000	100	RFMH0820	30,80
M8	30	1.000	100	RFMH0830	41,80



BUCHAS EM NYLON

Com alhetas para evitar a rotação durante a montagem

Ø		COD.	€ 100 UDS.
M6x30	100	RFTN0630	3,15
M8x40	100	RFTN0840	8,40
M10x50	50	RFTN1050	11,55
M12x60	25	RFTN1260	19,95



CINTA PERFURADA

Ideal para tubagens em PVC, baterias de tubo, condutas em suspensão, etc.

mm.	COMPRIM	CINTA mm.		COD.	€ 100 UDS.
M6x30	10 m.	17 x 0.8	10	RFCP0017	885,50

AQUECIMENTO

Na família de aquecimento, ATUSA continua a disponibilizar apenas qualidade ao mercado, com a distribuição – representação da marca GLOBAL. Esta prestigiada empresa italiana fabrica radiadores de alumínio fundido com um elevado nível de qualidade, garantindo fiabilidade e longa duração aos seus produtos.

Também, dispomos de radiadores toalheiros (nas diferentes versões), assim como uma gama de produtos complementares essenciais para este mercado, como: tampões, suportes, espelhos, purgadores e todo o tipo de acessórios relacionados.

GLOBAL 
RADIATORI



AQUECIMENTO

GL "A FORÇA DO CALOR"

O seu Design favorece o movimento do ar quente para a parte central do espaço a aquecer.



Modelo	DIMENSÕES (mm.)				Potencia Térmica EN 442				€
					ΔT 50° C		ΔT 30° C		
	Alto	Entre eixos	Ancho	Fundo	Watts	Kcal/H	Watts	Kcal/H	
GL 200/80/DOBLE	290	200	80	180	103	89	53	46	61,80
GL 350/80/DOBLE	440	350	80	180	157	136	80	69	64,00
GL 350/80	440	350	80	95	97	84	49	42	31,00
GL 500/80	590	500	80	95	126	109	64	55	31,50
GL 600/80	690	600	80	95	145	125	74	64	33,00
GL 700/80	790	700	80	95	166	143	84	73	37,40
GL 800/80	890	800	80	95	183	158	93	80	40,50

VIP "O CALOR INTERNO"

O seu Design favorece o movimento do ar quente para a parte central do espaço a aquecer.



Modelo	DIMENSÕES (mm.)				Potencia Térmica EN 442				€
					ΔT 50° C		ΔT 30° C		
	Alto	Entre eixos	Ancho	Fundo	Watts	Kcal/H	Watts	Kcal/H	
VIP 350	440	350	80	95	94	81	48	41	31,00
VIP 500	590	500	80	95	123	106	63	54	31,50
VIP 600	690	600	80	95	142	123	72	62	33,00
VIP 700	790	700	80	95	161	139	82	71	37,40
VIP 800	890	800	80	95	180	155	91	79	40,50

MIX "UM QUENTE ABRAÇO"

Linhas refinadas para proporcionar o máximo conforto nos lugares mais sofisticados.



Modelo	DIMENSÕES (mm.)				Potencia Térmica EN 442				€
					ΔT 50° C		ΔT 30° C		
	Alto	Entre eixos	Ancho	Fundo	Watts	Kcal/H	Watts	Kcal/H	
MIX 300	390	300	80	95	82	71	43	37	30,70
MIX 350	440	350	80	95	94	81	48	41	31,00
MIX 500	590	500	80	95	123	106	63	54	31,50
MIX 600	690	600	80	95	142	123	72	62	33,00
MIX 700	790	700	80	95	161	139	82	71	37,40
MIX 800	890	800	80	95	180	155	91	79	40,50

VOX "O PRAZER DO CALOR"

A tecnologia mais avançada e um Design exclusivo garantem prestações elevadas sem gastar mais energia.



Modelo	DIMENSÕES (mm.)				Potencia Térmica EN 442				€
					ΔT 50° C		ΔT 30° C		
	Alto	Entre eixos	Ancho	Fundo	Watts	Kcal/H	Watts	Kcal/H	
VOX 350	440	350	80	95	95	82	49	42	31,00
VOX 500	590	500	80	95	127	110	65	56	31,50
VOX 600	690	600	80	95	146	126	75	65	33,00
VOX 700	790	700	80	95	164	142	83	72	37,40
VOX 800	890	800	80	95	181	156	92	80	40,50

VOX EXTRA "Forte, Ligeiro e Elegante"

O perfeito equilíbrio entre o linear e a suavidade das curvas.



Modelo	DIMENSÕES (mm.)				Potencia Térmica EN 442				€
					ΔT 50° C		ΔT 30° C		
	Alto	Entre eixos	Ancho	Fundo	Watts	Kcal/H	Watts	Kcal/H	
VOX EXTRA 350	427	350	80	95	89	77	46	40	29,70
VOX EXTRA 500	577	500	80	95	119	103	61	53	30,20
VOX EXTRA 600	677	600	80	95	137	118	71	61	31,50
VOX EXTRA 700	777	700	80	95	156	135	80	69	35,70
VOX EXTRA 800	877	800	80	95	173	149	88	76	38,80

KLASS "LINHAS RECTAS E CURVAS"

A simbiose perfeita entre Design, funcionalidade e rendimento.



Modelo	DIMENSÕES (mm.)				Potencia Térmica EN 442				€
					ΔT 50° C		ΔT 30° C		
	Alto	Entre eixos	Ancho	Fundo	Watts	Kcal/H	Watts	Kcal/H	
KLASS 350	432	350	80	80	85	73	44	38	29,10
KLASS 500	582	500	80	80	116	100	60	52	29,60
KLASS 600	682	600	80	80	132	114	67	58	31,00
KLASS 700	782	700	80	80	148	128	75	65	35,20
KLASS 800	882	800	80	80	162	140	82	71	37,70

ISEO

"CALOR E ECONOMIA"

Conforto excepcional, maximizando o movimento do ar para a parte central do espaço a aquecer.



Modelo	DIMENSÕES (mm.)				Potencia Térmica EN 442				€
					ΔT 50° C		ΔT 30° C		
	Alto	Entre eixos	Ancho	Fundo	Watts	Kcal/H	Watts	Kcal/H	
ISEO 350	432	350	80	80	87	75	44	38	29,10
ISEO 500	582	500	80	80	115	99	58	50	29,60
ISEO 600	682	600	80	80	131	113	66	57	31,00
ISEO 700	782	700	80	80	150	130	75	65	35,20
ISEO 800	882	800	80	80	164	142	82	71	37,70

EKOS&EKOS PLUS

"IRRESISTIVELMENTE REDONDO"

Modelo Patenteado dentro da ampla gama da GLOBAL



Modelo	DIMENSÕES (mm.)				Potencia Térmica EN 442				€
					ΔT 50° C		ΔT 30° C		
	Alto	Entre eixos	Ancho	Fundo	Watts	Kcal/H	Watts	Kcal/H	
EKOS 500/95	568	500	50	95	61	53	32	28	32,50
EKOS 600/95	668	600	50	95	69	60	36	31	33,60
EKOS 700/95	768	700	50	95	78	67	40	35	38,20
EKOS 800/95	868	800	50	95	87	75	45	39	40,90
EKOS 600/130	683	600	50	130	87	75	45	39	38,70
EKOS 800/130	883	800	50	130	108	93	56	48	46,30
EKOS PLUS 900	970	900	50	95	101	87	53	46	67,00
EKOS PLUS 1000	1070	1000	50	95	109	94	57	49	73,40
EKOS PLUS 1200	1270	1200	50	95	126	109	64	55	87,00
EKOS PLUS 1400	1470	1400	50	95	143	123	72	62	98,20
EKOS PLUS 1600	1670	1600	50	95	160	138	80	69	108,00
EKOS PLUS 1800	1870	1800	50	95	178	154	90	78	117,20
EKOS PLUS 2000	2070	2000	50	95	196	169	99	86	130,70

OSCAR

"ALTO E FORTE"

O radiador vertical uma solução perfeita para espaços reduzidos.



Modelo	DIMENSÕES (mm.)				Potencia Térmica EN 442				€
					ΔT 50° C		ΔT 30° C		
	Alto	Entre eixos	Ancho	Fundo	Watts	Kcal/H	Watts	Kcal/H	
OSCAR 900	946	900	80	95	175	151	88	76	73,50
OSCAR 1000	1046	1000	80	95	190	164	95	82	79,00
OSCAR 1200	1246	1200	80	95	218	188	109	94	94,50
OSCAR 1400	1446	1400	80	95	245	211	123	106	105,00
OSCAR 1600	1646	1600	80	95	271	234	136	118	115,50
OSCAR 1800	1846	1800	80	95	297	256	148	128	126,00
OSCAR 2000	2046	2000	80	95	321	277	161	139	141,50

OSCAR TONDO

"A Evolução"

A combinação perfeita entre curvas e retas.



Modelo	DIMENSÕES (mm.)				Potencia Térmica EN 442				€
					ΔT 50° C		ΔT 30° C		
	Alto	Entre eixos	Ancho	Fundo	Watts	Kcal/H	Watts	Kcal/H	
OSCAR TONDO 900	946	900	80	95	175	151	88	76	73,50
OSCAR TONDO 1000	1046	1000	80	95	190	164	95	82	79,00
OSCAR TONDO 1200	1246	1200	80	95	218	188	109	94	94,50
OSCAR TONDO 1400	1446	1400	80	95	245	211	123	106	105,00
OSCAR TONDO 1600	1646	1600	80	95	271	234	136	118	115,50
OSCAR TONDO 1800	1846	1800	80	95	297	256	148	128	126,00
OSCAR TONDO 2000	2046	2000	80	95	321	277	161	139	141,50

JUNIOR

"O RADIADOR TOALHEIRO DE ALUMÍNIO"

Calor no banho e nas toalhas.



Modelo	DIMENSÕES (mm.)				Potencia Térmica EN 442				€
					ΔT 50° C		ΔT 30° C		
	Alto	Entre eixos	Ancho	Fundo	Watts	Kcal/H	Watts	Kcal/H	
JUNIOR 450/7	730	450	492	42	377	325	201	174	482,00
JUNIOR 450/10	970	450	492	42	488	421	260	225	553,00
JUNIOR 450/12	1210	450	492	42	597	515	319	276	658,00
JUNIOR 450/15	1540	450	492	42	743	641	396	342	810,00

PREÇOS EM BRANCO (RAL 9010) / OUTRAS CORES CONSULTAR

SEBINO

“ O ULTRALEVE ”

Qualidade, conforto, e design vanguardista.



Modelo	DIMENSÕES (mm.)				Potencia Térmica EN 442				Nº Elementos	€
					ΔT 50° C		ΔT 30° C			
	Alto	Entre eixos	Ancho	Fundo	Watts	kcal/H	Watts	kcal/H		
SEBINO 350	384	350	500	60	427	367	220	189	6	447,00
	384	350	660	60	569	489	293	252	8	555,00
	384	350	820	60	711	611	366	315	10	668,00
	384	350	980	60	853	733	439	377	12	782,00
	384	350	1140	60	995	856	512	440	14	895,00
SEBINO 500	534	500	500	60	550	473	281	242	6	498,00
	534	500	660	60	733	630	375	322	8	623,00
	534	500	820	60	916	788	469	403	10	754,00
	534	500	980	60	1.099	945	563	484	12	879,00
	534	500	1140	60	1.282	1.102	657	565	14	1.008,00
SEBINO 600	634	600	500	60	627	539	319	274	6	532,00
	634	600	660	60	836	719	426	366	8	669,00
	634	600	820	60	1.045	898	532	457	10	808,00
	634	600	980	60	1.254	1.078	638	549	12	945,00
	634	600	1140	60	1.463	1.258	745	641	14	1.088,00
SEBINO 700	734	700	500	60	701	603	356	306	6	567,00
	734	700	660	60	935	804	474	408	8	714,00
	734	700	820	60	1.169	1.005	593	510	10	867,00
	734	700	980	60	1.403	1.206	712	612	12	1.020,00
	734	700	1140	60	1.637	1.407	830	714	14	1.168,00
SEBINO 800	834	800	500	60	774	665	391	336	6	600,00
	834	800	660	60	1.032	887	522	449	8	754,00
	834	800	820	60	1.290	1.109	652	561	10	922,00
	834	800	980	60	1.548	1.331	782	672	12	1.081,00
	834	800	1140	60	1.806	1.553	913	785	14	1.247,00
SEBINO 900	934	900	500	60	844	726	425	365	6	723,00
	934	900	660	60	1.126	968	566	487	8	840,00
	934	900	820	60	1.407	1.210	708	609	10	1.029,00
	934	900	980	60	1.688	1.451	850	731	12	1.205,00
	934	900	1140	60	1.970	1.694	991	852	14	1.382,00
SEBINO 1000	1034	1000	500	60	913	785	458	394	6	706,00
	1034	1000	660	60	1.217	1.046	610	524	8	895,00
	1034	1000	820	60	1.521	1.308	763	656	10	1.088,00
	1034	1000	980	60	1.825	1.569	916	788	12	1.276,00
	1034	1000	1140	60	2.129	1.831	1.068	918	14	1.465,00
SEBINO 1200	1234	1200	340	60	697	599	348	299	4	548,00
	1234	1200	500	60	1.045	898	522	449	6	771,00
	1234	1200	660	60	1.394	1.199	696	598	8	982,00
	1234	1200	820	60	1.742	1.498	870	748	10	1.194,00
SEBINO 1400	1434	1400	340	60	782	672	388	334	4	593,00
	1434	1400	500	60	1.173	1.009	582	500	6	840,00
	1434	1400	660	60	1.564	1.345	776	667	8	1.081,00
	1434	1400	820	60	1.955	1.681	970	834	10	1.312,00
SEBINO 1600	1634	1600	340	60	864	743	429	369	4	662,00
	1634	1600	500	60	1.297	1.115	643	553	6	911,00
	1634	1600	660	60	1.729	1.487	858	738	8	1.170,00
	1634	1600	820	60	2.161	1.858	1.072	922	10	1.428,00
SEBINO 1800	1834	1800	340	60	944	812	468	402	4	698,00
	1834	1800	500	60	1.417	1.218	703	604	6	982,00
	1834	1800	660	60	1.889	1.624	937	806	8	1.260,00
	1834	1800	820	60	2.361	2.030	1.171	1.007	10	1.538,00
SEBINO 2000	2034	2000	340	60	1.026	882	509	438	4	725,00
	2034	2000	500	60	1.538	1.322	763	656	6	1.055,00
	2034	2000	660	60	2.051	1.763	1.018	875	8	1.350,00
	2034	2000	820	60	2.564	2.205	1.272	1.094	10	1.649,00

MODELO ULISSE

O modelo ULISSE é composto por tubos radiantes redondos de 25mm. A sua forma de cadência regular facilita a introdução das toalhas. Vêm equipados com 3 suportes e uma válvula purgadora de 1/2".

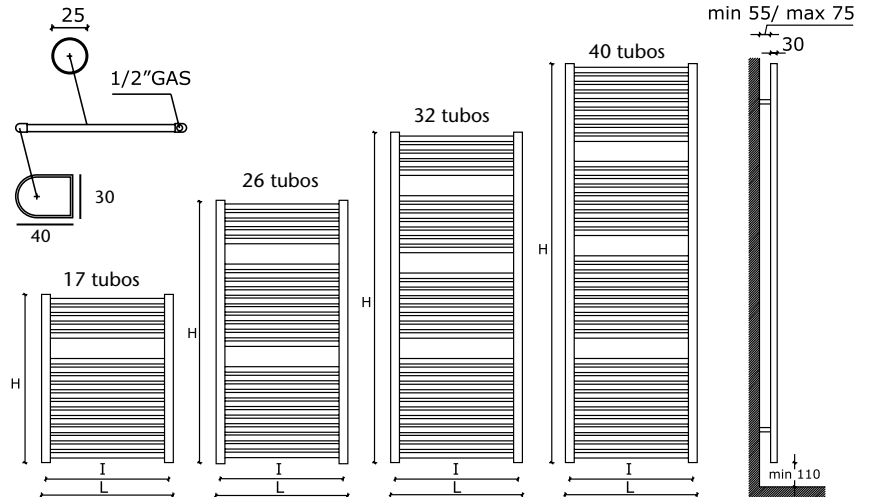

COD.	Altura mm. (H)	Largura mm. (L)	Entre Eixos mm. (I)	Potencia Térmica $\Delta T50^\circ$ EN 442 Watos/Kcal/h.	Branco (RAL 9010)	Cor A*	Cor B*	Cor C*	Cromado*
					€	€	€	€	€
GCU(C)0740	766 17 tubos 1 espaço	400	352	330/283	133,60	236,60	244,90	274,00	548,25
GCU(C)0745		450	402	362/311	135,75	240,75	250,10	280,20	558,90
GCU(C)0750		500	452	396/341	138,55	244,90	255,30	286,45	570,50
GCU(C)0755		550	502	430/370	143,45	255,30	264,65	295,80	591,85
GCU(C)0760		600	552	463/398	144,85	256,35	267,75	299,95	599,60
GCU(C)0775		750	702	565/486	150,50	265,70	277,10	309,25	618,00
GCU(C)0710		1000	952	735/632	159,65	283,30	293,70	327,95	0,00
GCU(C)1240	1185 26 tubos 2 espaços	400	352	486/417	192,00	339,35	351,80	395,40	788,45
GCU(C)1245		450	402	538/463	194,80	345,60	359,10	403,70	803,95
GCU(C)1250		500	452	592/509	198,30	350,80	365,30	410,95	818,50
GCU(C)1255		550	502	646/556	203,95	360,10	374,65	420,30	839,80
GCU(C)1260		600	552	700/602	205,35	365,30	379,85	424,45	848,50
GCU(C)1275		750	702	862/741	211,70	374,65	389,20	435,90	870,80
GCU(C)1210		1000	952	1132/974	216,60	384,00	398,50	446,25	0,00
GCU(C)1540	1506 32 tubos 3 espaços	400	352	612/526	231,35	412,00	427,60	478,45	956,05
GCU(C)1545		450	402	671/577	237,00	419,25	435,90	488,80	975,40
GCU(C)1550		500	452	733/630	241,20	427,60	445,20	498,15	996,70
GCU(C)1555		550	502	795/684	244,75	435,90	454,55	509,55	1.015,10
GCU(C)1560		600	552	858/738	247,55	439,00	456,65	512,70	1.022,85
GCU(C)1575		750	702	1045/899	257,40	455,60	472,20	528,25	1.057,75
GCU(C)1510		1000	952	1356/1166	267,95	475,30	494,00	552,10	0,00
GCU(C)1840	1817 40 tubos 3 espaços	400	352	750/645	278,50	492,95	512,70	574,95	1.145,90
GCU(C)1845		450	402	830/714	278,50	492,95	512,70	574,95	1.145,90
GCU(C)1850		500	452	909/782	282,70	501,25	523,05	584,30	1.169,15
GCU(C)1855		550	502	988/850	289,05	512,70	531,35	594,65	1.189,45
GCU(C)1860		600	552	1067/918	290,45	515,80	534,45	598,80	1.198,20
GCU(C)1875		750	702	1303/1121	302,40	533,45	556,25	622,70	1.245,65
GCU(C)1810		1000	952	1697/1459	317,85	563,55	587,40	657,95	-

*CONSULTAR LISTA DE CORES (E CÓDIGO (C) CORRESPONDENTE).

TAMPÕES PARA RADIADOR



TAMPÃO ZINCADO 1"

MEDIDA		COD.	€
1"	100	GZ5TCDCCH	0,60
1"	100	GZ5TCIZQ	0,60
1" x 1/8"	100	GZ5TR(D/I)A0	0,60
1" x 1/4"	100	GZ5TR(D/I)A1	0,60
1" x 3/8"	100	GZ5TR(D/I)A2	0,60
1" x 1/2"	100	GZ5TR(D/I)A3	0,60
1" x 3/4"	100	GZ5TR(D/I)A4	0,77

(D) Direito (I) Esquerdo



TAMPÃO BRANCO 1"

MEDIDA		COD.	€
1"	100 10	GA5TCDCW	0,84
1"	100 10	GA5TCIZW	0,84
1" x 1/8"	100 10	GA5TR(D/I)W0	0,84
1" x 1/4"	100 10	GA5TR(D/I)W1	0,84
1" x 3/8"	100 10	GA5TR(D/I)W2	0,84
1" x 1/2"	100 10	GA5TR(D/I)W3	0,84
1" x 3/4"	100 10	GA5TR(D/I)W4	1,00

(D) Direito (I) Esquerdo



TAMPÃO ZINCADO 1" COM VEDAÇÃO DE SILICONE

MEDIDA		COD.	€
1"	100	GZ4TCDCCH	0,77
1"	100	GZ4TCIZQ	0,77
1" x 1/8"	100	GZ4TR(D/I)A0	0,77
1" x 3/8"	100	GZ4TR(D/I)A2	0,77
1" x 1/2"	100	GZ4TR(D/I)A3	0,77

(D) Direito (I) Esquerdo



TAMPÃO BRANCO 1" COM VEDAÇÃO DE SILICONE

MEDIDA		COD.	€
1"	100 10	GA4TCDCW	1,00
1"	100 10	GA4TCIZW	1,00
1" x 1/8"	100 10	GA4TR(D/I)W0	1,00
1" x 3/8"	100 10	GA4TR(D/I)W2	1,00
1" x 1/2"	100 10	GA4TR(D/I)W3	1,00

(D) Direito (I) Esquerdo



TAMPÃO ZINCADO 1" (Ø 47) (RADIADOR DE CHAPA OU FUNDIÇÃO)

MEDIDA		COD.	€
1"	100	GZ5TC48D	0,90
1"	100	GZ5TC48I	0,90
1" x 1/8"	100	GZ548(D/I)A0	0,90
1" x 1/4"	100	GZ548(D/I)A1	0,90
1" x 3/8"	100	GZ548(D/I)A2	0,90
1" x 1/2"	100	GZ548(D/I)A3	0,90

(D) Direito (I) Esquerdo



TAMPÃO ZINCADO 1 1/4" (RADIADOR DE CHAPA OU FUNDIÇÃO)

MEDIDA		COD.	€
1 1/4"	50	GZ6TCDCCH	2,20
1 1/4"	50	GZ6TCIZQ	2,20
1 1/4" x 3/8"	50	GZ6TR(D/I)A2	2,45
1 1/4" x 1/2"	50	GZ6TR(D/I)A3	2,45
1 1/4" x 3/4"	50	GZ6TR(D/I)A4	3,00

(D) Direito (I) Esquerdo



CHAVE NYLON PARA TAMPÕES

MEDIDA		COD.	€
20-30mm.	10	RXXOMELL	4,00

Nota: Os tampões de radiador possuem roscas cilíndricas concebidas para realizar uma união mecânica não estanque, devido a isso é necessário o uso de elementos vedantes que garantem a estanquidade.



KIT UNIVERSAL DE TAMPÕES ZINCADOS 1"

MEDIDA	CONTENIDO	COD.	€
1" x 1/2"	2 Reduções direitas 2 Reduções esquerdas	GA50ZKIT	5,70
1" x 3/8"	4 juntas de silicone, 1 tampão cego com o-ring e 1 purgador.	GA38ZKIT	5,70



KIT UNIVERSAL DE TAMPÕES BRANCOS 1"

MEDIDA	CONTENIDO	COD.	€
1" x 1/2"	2 Reduções direitas 2 Reduções esquerdas	GA50WKIT	6,80
1" x 3/8"	4 juntas de silicone, 1 tampão cego com o-ring e 1 purgador.	GA38WKIT	6,80



KIT UNIVERSAL DE TAMPÕES ZINCADOS 1" + PURGADOR AUTOMÁTICO DE BOIA CROMADO

CONTENIDO	COD.	€
2 reduções direitas 1"x1/2", 1 tampão cego esquerdo 1", 3 juntas de silicone e 1 purgador automático de boia 1" esquerdo.	GA50ZKPD	10,20
2 reduções esquerdas 1"x1/2", 1 tampão cego direito 1", 3 juntas de silicone e 1 purgador automático de boia 1" direito.	GA50ZKPI	10,20



KIT UNIVERSAL DE TAMPÕES BRANCOS 1" + PURGADOR AUTOMÁTICO DE BOIA BRANCO

CONTENIDO	COD.	€
2 reduções direitas 1"x1/2", 1 tampão cego esquerdo 1", 3 juntas de silicone e 1 purgador automático de boia 1" esquerdo.	GA50WKPD	13,00
2 reduções esquerdas 1"x1/2", 1 tampão cego direito 1", 3 juntas de silicone e 1 purgador automático de boia 1" direito.	GA50WKPI	13,00



KIT UNIV. DE TAMPÕES ZINCADOS 1" + SUPORTES RADIADOR ZINCADOS

MEDIDA	CONTENIDO	COD.	€
1" x 1/2"	2 Reduções direitas, 2 reduções esquerdas, 4 juntas de silicone, 1 tampão cego com o-ring, 1 purgador e 2 suportes plastificados (com buchas Ø 10 x 80).	GA50ZKIS	6,80
1" x 3/8"		GA38ZKIS	6,80



KIT UNIV. DE TAMPÕES BRANCOS 1" + SUPORTES RADIADOR BRANCOS

MEDIDA	CONTENIDO	COD.	€
1" x 1/2"	2 Reduções direitas, 2 reduções esquerdas, 4 juntas de silicone, 1 tampão cego com o-ring, 1 purgador e 2 suportes plastificados (com buchas Ø 10 x 80).	GA50WKIS	8,10
1" x 3/8"		GA38WKIS	8,10

JUNTAS PARA TAMPÕES DE RADIADOR



JUNTA ÚTIL POLIESTER PARA TAMPÃO 1"

5.000	100	COD.	€
		GA7GUTIL	0,105

(*) Não se aconselha o uso desta junta em instalações com anticongelante ou outros aditivos



JUNTA ECOLÓGICA SEM AMIANTO PARA TAMPÃO

MEDIDA	Ø	ESPESSURA	100	COD.	€
1/2"	27	1,5 mm.	100	GA7GECO3 (1)	0,075
1"	42	1,5 mm.	100	GA7GECO1	0,075
1"	47	1,5 mm.	100	GA7GEC48	0,130
1 1/4"	56	1,5 mm.	100	GA7GECO6	0,170

(1) Até fim de existências

PURGADORES



**PURGADOR MANUAL ORIENTÁVEL
("DE MOEDA")**

MEDIDA		COD.	€
1/8"	1.000 50	RXX19002	1,00



**PURGADOR AUTOMÁTICO
DE BOIA 1"**

TIPO	ACABAMENTO		COD.	€
Direito	Niquelado	100 10	GA13PURD	6,00
Esquerdo	Niquelado	100 10	GA13PURI	6,00
Direito	Branco	100 10	GA13PBLD	7,70
Esquerdo	Branco	100 10	GA13PBLL	7,70



PURGADOR AUTOMÁTICO

MEDIDA		COD.	€
3/8"	80 10	RX970002	8,50
1/2"	80 10	RX970003	8,60



**PURGADOR AUTOMÁTICO
"MINI"**

MEDIDA		COD.	€
3/8"	80 10	RX970B02	6,80
1/2"	80 10	RX970B03	7,00

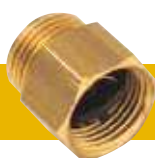

**VÁLVULA RETENÇÃO PARA
PURGADOR**

MEDIDA		COD.	€
H3/8" - M3/8"	100	RX971002	1,60
H1/2" - M1/2"	100	RX971003	1,95

SUPORTES PARA RADIADOR



**SUPORE TELESCÓPICO ZINCADO
Ø 7 MM. (2 UNI + BUCHAS)**

	COD.	€ BOLSA 2 UNID.
50 bolsas 2 unid.	RXX94201	1,20



**SUPORE TELESCÓPICO ZINCADO
Ø 7 MM. (2 UNI + BUCHAS)**

	COD.	€ BOLSA 2 UNID.
50 bolsas 2 unid.	RXX942MS	1,30



**SUPORE TELESCÓPICO
PLASTIFICADO BRANCO Ø 7 MM.
(2 UNI + BUCHAS)**

	LONGITUD mm.	COD.	€ BOLSA 2 UNID.
50 bolsas 2 unid.	170 mm.	RXX942MB	1,95
50 bolsas 2 unid.	195 mm.	RXX94LMB	2,40



JOGO DE SUPORTE REGULÁVEL DE 1" (2 UNID.)

	COD.	€
50	GA5SORE2	2,90



SUPORTE FIXO 1"

	COD.	€
50	GA5SOFIJ	0,95



SUPORTE RETO PARA ENCASTRAR

	COD.	€
100	GA1SOEMP	0,68



95MM Comp total (75mm meia curva) 2mm de ESPESSURA.

SUPORTE DE ESQUADRIA REVERSÍVEL

ACABAMENTO		COD.	€
Branco Plastificado	100	GA3SOBRE	1,60



SUPORTE DE NYLON (1 PATILHA)

	COD.	€
500	GA3STERM	0,60



SUPORTE DE NYLON (3 PATILHAS)

	COD.	€
500	GA3STER3	0,60



SUPORTE DE NYLON "ANTI-RUIDO" (1 PATILHA)

	COD.	€
500	GA3SUTIL	0,60



MOD. UNIVERSAL PARA QUALQUER TIPO DE RADIADOR

SUPORTE DE NYLON (3 PATILHAS)

	COD.	€
500	GA3SUN3	0,62



MOD. UNIVERSAL PARA QUALQUER TIPO DE RADIADOR

GLOBAL
RADIATORI

	COD.	€
100 1	GA27SREG	6,90



SUPORTE DE CHÃO

GLOBAL
RADIATORI

ACABAMENTO		COD.	€
Branco	2	GA15DOBL	40,00

OUTROS ACESSÓRIOS



CASQUILHOS

MEDIDA		COD.	€
1"	100	GA9CASQ1	0,37
1 1/4"	50	GA9CASQ6	0,70



JUNTA ECOLÓGICA SEM AMIANTO PARA CASQUILHO (ESPESSURA 1 mm.)

MEDIDA		COD.	€
1" (Ø 42)	100	GA8GCEC5	0,070
1" (Ø 48)	100	GA8GCE48	0,095
1 1/4" (Ø 56)	100	GA8GCEC6	0,165



ESPELHO UNIVERSAL

MEDIDA		COD.	€	
10 - 25 mm.	1.000	100	RAFU1025	0,30



ESPELHO ELÁSTICO

MEDIDA		COD.	€	
10 - 22 mm.	3.000	100	RAFUTIL	0,115



ESPELHO UNIVERSAL DUPLO

MEDIDA		COD.	€	
35 mm. - entre ejes	500	25	RAFUDOBL	0,50



TINTA SPRAY BRANCO



	COD.	€
12	GA1BLACA	7,70



CHAVE DE MONTAGEM COM ALAVANCA



	COD.	€
1	GA13LLAV	46,00



CASQUILHO (30 mm.) PARA RADIADOR "OSCAR" E "EKOS PLUS"



	COD.	€
50	GOSNIPLE	0,70



DIAFRAGMA PARA "OSCAR" E "EKOS PLUS"



	COD.	€
1	GOSDIAFR	3,60



O-RING PARA TAMPÃO E CASQUILHO PARA MODELOS "OSCAR", "JUNIOR" E "EKOS PLUS"



	COD.	€
10	GOSGUARN	0,80



valve cimberio®

technological solutions



VÁLVULAS
CIMBERIO

valve
cim



VÁLVULAS DE COMPUERTA



VÁLVULAS DE EQUILIBRIO / VÁLVULAS INDUSTRIALES

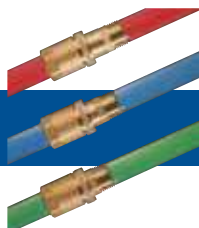

RACORES



VÁLVULAS DE ESFERA



SOLAR TÉRMICO



VÁLVULAS DE ESFERA PARA ACOMETIDA DE AGUAS



VÁLVULAS DE ESFERA CON ACTUADOR
VÁLVULAS MEZCLADORAS CON ACTUADOR



GRIFOS, BOCAS DE RIEGO DE ESFERA
Y VÁLVULAS DE ESFERA SERIE "MINI"



VÁLVULAS Y LLAVES DE ESFERA PARA GAS

SOLICITAR CATÁLOGO CIMBERIO

cim 10



Robinet à boisseau sphérique à passage intégral SÉRIE T10
Válvula de esfera de paso total SERIE T10

cim 310



DN	1/4"	3/8"	1/2"	3/4"	1"	1 1/4"	1 1/2"	2"	2 1/2"	3"	4"
€	6,84	6,84	9,90	15,24	20,94	33,60	43,62	72,19	165,75	246,14	437,83
Box Cim 10	50	50	25	16	12	6	5	3	2	1	1
Cart. Cim 10	100	100	100	64	48	24	20	12	4	2	2
Box Cim 310	50	50	35	20	15	10	6	3	-	-	-
Cart. Cim 310	100	100	140	80	60	40	24	12	-	-	-

cim 12



Robinet à boisseau sphérique à passage intégral SÉRIE T12
Válvula de esfera de paso total SERIE T12

cim 312



DN	1/4"	3/8"	1/2"	3/4"	1"	1 1/4"	1 1/2"	2"	2 1/2"	3"	4"
€	5,44	5,44	7,81	11,24	16,64	24,22	36,19	53,81	123,86	187,11	290,01
Box Cim 11-12	50	50	40	25	16	10	6	4	2	2	2
Cart. Cim 11-12	200	200	160	100	64	40	24	16	-	-	-
Box Cim 312	50	50	50	30	20	12	7	4	-	-	-
Cart. Cim 312	200	200	200	120	80	48	28	16	-	-	-



cim 12 NPT



Robinet à boiss. sphér. à pass. intégral fil. "NPT" SÉRIE T12
Válvula de esfera de paso total ros. "NPT" SERIE T12

312 NPT



DN	1/4"	3/8"	1/2"	3/4"	1"	1 1/4"	1 1/2"	2"	2 1/2"	3"	4"
€	5,44	5,44	7,81	11,24	16,64	24,22	36,19	53,81	123,86	187,11	290,01
Box Cim 11-12 NPT	50	50	40	25	16	10	6	4	2	2	2
Cart. Cim 11-12 NPT	200	200	160	100	64	40	24	16	-	-	-
Box Cim 312 NPT	50	50	50	30	20	12	7	4	-	-	-
Cart. Cim 312 NPT	200	200	200	120	80	48	28	16	-	-	-



cim 12 CR



Robinet à boiss. sphér. à pass. intégral en laiton "CR" SÉRIE T12
Válvula de esfera de paso total de latón "CR" brass SERIE T12

cim 312 CR



DN	1/4"	3/8"	1/2"	3/4"	1"	1 1/4"	1 1/2"	2"	2 1/2"	3"	4"
€	6,86	6,86	9,59	13,73	20,33	30,39	44,08	65,77	-	-	-
Box Cim 11-12 CR	50	50	40	25	16	10	6	4	-	-	-
Cart. Cim 11-12 CR	200	200	160	100	64	40	24	16	-	-	-
Box Cim 312 CR	50	50	50	30	20	12	7	4	-	-	-
Cart. Cim 312 CR	200	200	200	120	80	48	28	16	-	-	-

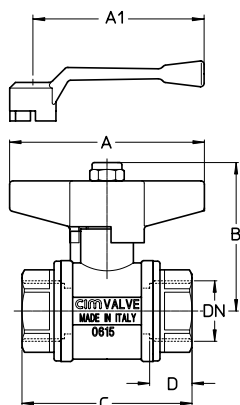

	DN	1/4"	3/8"	1/2"	3/4"	1"	1 1/4"	1 1/2"	2"	2 1/2"	3"	4"
Cim 10 Cim 310	Grms.	180	185	340	610	830	1325	1730	3000	5800	8400	13500
	A	50	50	70	85	85	100	100	100	-	-	-
	A1	80	80	100	120	120	150	150	150	240	240	310
	B - A1	55	55	59	72	76	95	100	107	142,5	153,5	184,5
	C	47	50	64	74	88	101	106	130	158	183	222
Cim 12 Cim 12 CR Cim 11 Cim 11 CR Cim 312 Cim 312 CR	Grms.	115	120	220	360	590	915	1355	2060	4255	6210	10000
	A	43	43	50	70	70	85	100	100	-	-	-
	A1	65	65	80	100	100	120	150	150	240	240	310
	B - A1	33	33	57	62	66	79	100	107	142,5	153,5	184,5
	C	45	47	61	68	82	92	106	125	150,5	171	205
Cim 11 NPT Cim 12 NPT Cim 312 NPT	Grms.	115	120	200	330	480	785	1165	1660	3100	4250	7100
	A	43	43	50	70	70	85	100	100	-	-	-
	A1	65	65	80	100	100	120	150	150	240	240	310
	B - A1	33	33	57	62	66	80	100	107	142,5	153,5	184,5
	C	47	47	61	68	82	92	106	125	150,5	171	205
D	11,5	12,5	17	18,5	21	22,5	23	26,5	27	28	35	

cim 14



Robinet à boisseau sphérique à passage intégral SÉRIE T14
Válvula de esfera de paso total SERIE T14

cim 314

DN	1/4"	3/8"	1/2"	3/4"	1"	1 1/4"	1 1/2"	2"	2 1/2"	3"	4"
€	5,44	5,44	6,68	9,31	12,82	20,64	31,10	47,01	93,05	132,40	223,77
Box Cim 14-14 M	50	50	40	25	20	12	6	4	4	2	2
Cart. Cim 14-14 M	200	200	160	100	80	48	24	16			
Box Cim 314	50	50	50	30	20	12	8	5			
Cart. Cim 314	200	200	200	120	80	48	32	20			



cim 16



Robinet à boisseau sphérique à passage intégral SÉRIE T16
Válvula de esfera de paso total SERIE T16

cim 316

DN	1/4"	3/8"	1/2"	3/4"	1"	1 1/4"	1 1/2"	2"
€	5,44	5,44	7,02	9,77	13,45	21,20	32,66	49,34
Box Cim 16-17	50	50	40	25	16	10	6	4
Cart. Cim 16-17	100	100	160	100	64	40	24	16
Box Cim 316	50	50	50	30	20	10	7	4
Cart. Cim 316	100	100	200	120	80	40	28	16



cim 16.1 NPT



Robinet à boiss. sphér. à pass. intégral fil. "NPT" SÉRIE T16
Válvula de esfera de paso total ros. "NPT" SERIE T16

316.1 NPT

DN	1/4"	3/8"	1/2"	3/4"	1"	1 1/4"	1 1/2"	2"
€	5,44	5,44	6,10	8,50	12,43	19,53	31,12	45,72
Box 16.1-17.1 NPT	50	50	40	25	16	10	6	4
Cart. 16.1-17.1 NPT	100	100	160	100	64	40	24	16
Box Cim 316.1 NPT	50	50	50	30	20	10	7	4
Cart. Cim 316.1 NPT	100	100	200	120	80	40	28	16



cim 16 CR



Robinet à boiss. sphér. à pass. intégral en laiton "CR" SÉRIE T16
Válvula de esfera de paso total de latón "CR" brass SERIE T16

cim 316 CR

DN	1/4"	3/8"	1/2"	3/4"	1"	1 1/4"	1 1/2"	2"
€	-	-	6,59	9,39	14,03	21,65	34,94	51,98
Box Cim 16-17 CR	-	-	40	30	16	10	6	4
Cart. Cim 16-17 CR	-	-	160	120	64	40	24	16
Box Cim 316 CR	-	-	50	30	20	10	7	4
Cart. Cim 316 CR	-	-	200	120	80	40	28	16

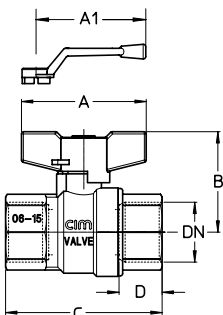

	DN	1/4"	3/8"	1/2"	3/4"	1"	1 1/4"	1 1/2"	2"	2 1/2"	3"	4"
Cim 14 Cim 14 M Cim 314	Grms.	115	120	200	330	480	785	1165	1660	3100	4250	7100
	A	43	43	50	70	70	85	100	100	-	-	-
	A1	65	65	80	100	100	120	150	150	240	240	240
	B - A1	33	33	57	62	66	79	100	107	137,5	146,5	161,5
	C	45	47	52	57	68	81	95,5	112	133	150	177
Cim 16 Cim 17 Cim 316	Grms.	115	120	190	300	495	760	1170	1740	Cim 11-11CR-11NPT-14M L'étanchéité sur la tige est garantie par deux O-Rings en FKM. La tige est placée à l'intérieur de la capsule scellée au corps du robinet.		
	A	43	43	55	55	75	75	105	105	La estanqueidad del eje está garantizada con dos O-rings de FKM. El eje está alojado en el interior de una capsula sellada al cuerpo de la válvula.		
	A1	65	65	90	90	110	110	150	150	Cim 16-17-16CR-17CR Cim 16.1 NPT - 17.1 NPT La tige antiéclabotante est placée à l'intérieur du robinet. L'étanchéité est assurée par deux O-rings en HNBR/75. El eje de tipo antiestallido está dentro de la válvula. La estanqueidad se garantiza a través de 2 O-rings de HNBR/75.		
	B - A1	33	33	50	54	63	72	82	90			
	C	45	47	62	69	83,5	96	109	130,5			
Cim 16 CR Cim 17 CR Cim 316 CR Cim 16.1 NPT Cim 17.1 NPT Cim 316.1 NPT	Grms.	115	120	185	280	465	710	1060	1590			
	A	43	43	55	55	75	75	105	105			
	A1	65	65	90	90	110	110	150	150			
	B - A1	33	33	50	54	63	72	82	90			
	C	45	47	55	60	74	81	96	112			
D	11,5	12,5	14	14,5	17	17,5	18	20				

cim 406



cim 407



cim 408



Robinet à boisseau sphérique SÉRIE T10 comm.ande par capuchon 28x28
Válvulas de esfera SERIE T10 con cuadradillo 28x28



DN	1/4"	3/8"	1/2"	3/4"	1"	1 1/4"	1 1/2"	2"	2 1/2"	3"
€ Cim 406	10,48	10,51	14,37	20,68	26,54	39,85	50,40	82,24	202,13	306,08
Box Cim 406	50	50	30	20	12	10	6	3	2	1
€ Cim 407	10,73	10,94	14,61	21,72	27,34	41,73	53,28	84,85	-	-
Box Cim 407	50	50	30	20	12	10	6	3	-	-
€ Cim 408	10,98	11,30	14,91	22,77	28,13	43,65	56,14	86,70	-	-
Box Cim 408	50	50	30	20	12	10	6	3	-	-

cim 406/12



cim 407/12



cim 408/12



Robinet à boisseau sphérique SÉRIE T12 comm.ande par capuchon 28x28
Válvulas de esfera SERIE T12 con cuadradillo 28x28



DN	1/4"	3/8"	1/2"	3/4"	1"	1 1/4"	1 1/2"	2"	2 1/2"	3"
€ Cim 406/12	-	-	11,36	14,87	20,55	30,16	42,28	63,53	149,55	215,93
Box Cim 406/12	-	-	40	25	20	12	7	4	2	1
€ Cim 407/12	-	-	11,49	15,10	20,85	30,39	42,86	64,45	-	-
Box Cim 407/12	-	-	40	25	20	12	7	4	-	-
€ Cim 408/12	-	-	12,02	15,58	21,40	30,90	43,43	64,97	-	-
Box Cim 408/12	-	-	40	25	20	12	7	4	-	-

cim 406/14



cim 407/14



cim 408/14



Robinet à boisseau sphérique SÉRIE T14 comm.ande par capuchon 28x28
Válvulas de esfera SERIE T14 con cuadradillo 28x28



DN	1/4"	3/8"	1/2"	3/4"	1"	1 1/4"	1 1/2"	2"	2 1/2"	3"
€ Cim 406/14	-	-	10,73	13,66	17,71	26,92	38,22	53,60	116,59	167,30
Box Cim 406/14	-	-	40	25	20	12	8	5	2	1
€ Cim 407/14	-	-	10,98	14,16	18,34	27,72	39,47	56,68	-	-
Box Cim 407/14	-	-	40	25	20	12	8	5	-	-
€ Cim 408/14	-	-	12,02	15,58	21,40	30,90	43,43	64,97	-	-
Box Cim 408/14	-	-	40	25	20	12	8	5	-	-



Le raccord télescopique en trois pièces Racor telescópico de dilatación de 3 piezas

cim 341

**Raccord télescopique en trois pièces femelle/mâle
Racor de dilatación de 3 piezas - hembra/macho**

DN	1/2"	3/4"	1"	1 1/4"	1 1/2"	2"
€	10,78	12,89	18,48	30,45	31,97	46,20
Box	40	25	15	10	12	7
Cart.	160	100	60	40	48	28

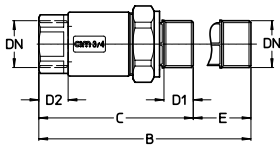

DN	1/2"	3/4"	1"	1 1/4"	1 1/2"	2"
Grms.	245	320	465	725	855	1395
B	113	119,5	130,5	128,5	132	144
C	81	87	96	103,5	107	119
D1	15	16,5	19	20	20	23
D2	14,5	16,5	19	22,5	22	25
E	32	32,5	34,5	25	25	25

Pour un emploi correct, il est recommandé d'installer le raccord télescopique avec une ouverture de 50% pour garantir une dilatation appropriée.

Para su uso correcto, se recomienda instalar el racor telescópico con una apertura del 50% para garantizar una dilatación adecuada.

UTILISATIONS: *furbo* résout aussi bien les problèmes dans les installations traditionnelles que spécifiques.

Il a été étudié en particulier pour les installations hydrauliques, de chauffage, sanitaires, pneumatiques et similaires, et il permet de raccorder facilement les extrémités opposées des tuyauteries, ou une extrémité d'une tuyauterie avec un composant hydraulique, comme une vanne, un compteur, une pompe de chauffage ou autre, qui doit être incorporé dans l'installation.

APLICACIONES: *furbo* resuelve los problemas de las instalaciones tradicionales y de las instalaciones específicas.

Se ha diseñado especialmente para las instalaciones hidráulicas, de calefacción, sanitarias, neumáticas y similares. Permite unir de manera rápida y sencilla los extremos contrapuestos de tubos o un extremo y un racor de un componente hidráulico como una válvula, un contador, una bomba de calefacción o similar que se quiera incorporar a la instalación.

ATOUTS:

- Sa construction permet une installation facile et rapide parce qu'il s'adapte chaque fois aux distances entre les filetages à raccorder.
- Élimination du réglage complémentaire et de l'adaptation parce que les différentes longueurs des parties à remplacer, comme les vannes, sont compensées par l'extensibilité du raccord.
- Son adaptabilité en fait une pièce facile à monter et à démonter dans les nouvelles installations ou dans les installations en cours de réparation, ou exigeant le remplacement de pièces.
- Remplacement à grandes tolérances de la partie du tube percée ou cassée en excluant les opérations d'adaptation ultérieures.
- *furbo* peut s'employer sur des installations de pompes ou thermiques, dans les points sollicités thermiquement, en servant simultanément de joint et de **RACCORD TÉLESCOPIQUE**.
- L'élasticité de *furbo* permet d'absorber parfaitement les dilatactions du tuyau, en éliminant toutes contraintes mécaniques qui pourraient agir négativement sur les points de raccordement des filetages.

VENTAJAS:

- Su diseño permite una aplicación sencilla y rápida adaptándose en cada caso a la distancia entre las rosas que hay que unir.
- Eliminación de trabajos suplementarios y de adaptación puesto que las diferencias de longitud frecuentes entre los componentes que hay que sustituir (ej. las válvulas) se compensan con la extensión del racor.
- Fácil montaje y desmontaje tanto en las nuevas instalaciones como en las ya existentes en las que haya que realizar reparaciones o sustituir componentes, gracias a su adaptabilidad.
- Sustitución con amplias tolerancias de la parte de la tubería que tiene pérdidas o está rota, eliminando, por tanto, los trabajos posteriores de adaptación.
- Además, *furbo* se puede utilizar en instalaciones de bombas o instalaciones térmicas, en puntos afectados térmicamente, sirviendo al mismo tiempo de racor y de **JUNTA DE DILATACIÓN**.
- La elasticidad de *furbo* permite absorber totalmente las dilataciones que se producen en el tubo evitando los esfuerzos mecánicos que podrían afectar negativamente a las uniones roscadas.

cim 34



Rubistar
 Robinet à boisseau sphérique avec porte-caoutchouc - nickelé
 Grifo de esfera con portagoma - niquelado

DN	3/8"	1/2"	3/4"	1"
€	8,72	8,72	13,63	21,89
Box Cim 34	25	25	20	10
Cart. Cim 34	100	100	80	40
Box Cim 334	30	25	20	10
Cart. Cim 334	120	100	80	40

cim 334



cim 34 PL



Rubistar
 Robinet à boisseau sphérique avec fente porte-cadenas
 Grifo de esfera con ranura portacandado

DN	3/8"	1/2"	3/4"	1"
€ Cim 34 PL	11,66	11,66	16,90	-
Box	25	20	15	-
Cart.	100	80	60	-
€ Cim 34 LUC	24,84	24,84	29,95	-

cim 34 LUC



cim 34 NR



Rubistar
 Robinet à boisseau sphérique avec clapet de non-retour
 Grifo de esfera con válvula antirretorno

DN	3/8"	1/2"	3/4"	1"
€	-	11,04	18,21	-
Box Cim 34 NR	-	25	20	-
Cart. Cim 34 NR	-	100	80	-
Box Cim 334 NR	-	25	20	-
Cart. Cim 334 NR	-	100	80	-

cim 334 NR



cim 34 SI



Rubistar
 Robinet à boisseau sphérique avec poignée à serrure
 Grifo de esfera con maneta y llave

DN	3/8"	1/2"	3/4"	1"
€ Cim 34 SI	38,16	38,16	43,08	51,33
Box	20	20	15	10
Cart.	80	80	60	40
€ Cim 34 NRSI	-	40,45	47,63	-

cim 34 NRSI



cim 36



Rubistar
 Robinet à boisseau sphérique sans porte-caoutchouc - nickelé
 Grifo de esfera sin portagoma - niquelado

DN	3/8"	1/2"	3/4"	1"
€	8,11	8,11	12,51	19,97
Box Cim 36	25	25	20	10
Cart. Cim 36	100	100	80	40
Box Cim 336	30	30	20	15
Cart. Cim 336	120	120	80	60

cim 336



cim 34 OT



RubiStar
 Robinet à boisseau sphérique avec poignée en laiton
 Grifo de esfera con maneta de latón



		AVEC PORTE-CAOUTCHOUC / CON PORTAGOMA	
DN		1/2"	3/4"
€ Cim 34 OT		9,54	14,51
Box Cim 34 OT		25	20
Cart. Cim 34 OT		100	80

		RACCORD RAPIDE / UNIÓN RÁPIDA	
DN		1/2"	3/4"
€ Cim 34 OT AR		26,07	38,31
Box Cim 34 OT AR		15	10
Cart. Cim 34 OT AR		60	40

cim 34 OT AR



cim 34 AR



RubiStar
 Robinet à boisseau sphérique pour raccord rapide
 Grifo de esfera para ataque rápido



		RACCORD RAPIDE ATAQUE RÁPIDO	
DN		1/2"	3/4"
Tuyau en caoutchouc Tubo de goma		Ø12 - 15	Ø16 - 19
€ Cim 34 AR		25,26	37,43
Box Cim 34 AR		15	10
Cart. Cim 34 AR		60	40

		CON PORTAGOMm.A RÁPIDO CON PORTAGOMA RÁPIDORÁPIDO	
DN		1/2"	3/4"
Tuyau en caoutchouc Tubo de goma		Ø12 - 15	Ø16 - 19
€ Cim 34 PR		11,09	17,10
Box Cim 34 PR		15	10
Cart. Cim 34 PR		60	40

cim 34 PR



cim 35



Raccord rapide
 Racor para ataque rápido

		Tuyau en caoutchouc Tubo de goma	
DN		Ø12 - 15	Ø16 - 19
€ Cim 35		19,25	24,40
Box Cim 35		50	50
Cart. Cim 35		100	100

		Tuyau en caoutchouc Tubo de goma	
DN		Ø12 - 15	Ø16 - 19
€ Cim 35 PR		5,09	7,54
Box Cim 35 PR		50	50
€ Cim 35 AR		14,17	16,87
Box Cim 35 AR		50	50

cim 35 PR



cim 35 AR



cim 99



Cim 99 Robinet maraicher à boisseau sphérique - Cim 500 Garden box
 Cim 99 boca de riego de esfera - Cim 500 Garden box



DN		1/2"x3/4"	1/2"x1"	3/4"x3/4"	3/4"x1"	1"x1 1/4"
€ Cim 99		15,43	-	16,53	18,37	31,50
Box Cim 99		25	-	25	20	8
Cart. Cim 99		100	-	100	80	32
€ Cim 500		54,59	61,02	54,82	61,02	-
Box Cim 500		2	2	2	2	-
Cart. Cim 500		10	10	10	10	-

cim 500

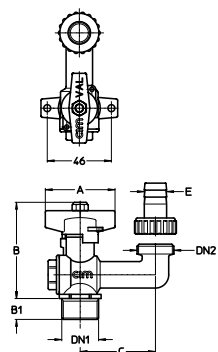

DN 1 x DN 2	1/2"x3/4"	3/4"x3/4"	3/4"x1"	1"x1 1/4"
Grms.	360	365	420	830
A	50	50	50	85
B	69	69	74	89
B1	15	15	15	29
C	54	54	54	80
E	16	16	22	28

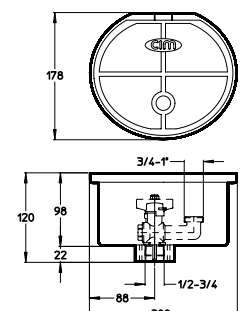

cim 70 B



Vanne de type standard - PN 20 / Válvula de compuerta tipo estándar - PN 20

DN												PN 10	
	1/4"	3/8"	1/2"	3/4"	1"	1 1/4"	1 1/2"	2"	2 1/2"	3"	4"	5"	6"
€	7,20	7,20	7,97	10,82	14,23	20,54	27,28	40,36	61,55	85,06	178,04	422,66	561,60
Box	50	50	35	25	16	10	8	5	2	2	2	1	1
Cart.	100	100	140	100	64	40	32	20	12	8	4	2	2

cim 70 BS



Vanne de type EN 12288/B (BS 5154/B) - PN 25 Válvula de compuerta tipo - EN 12288/B (BS 5154/B) type - PN 25

LIC. N° KM 553179 - PN 25

DN	1/4"	3/8"	1/2"	3/4"	1"	1 1/4"	1 1/2"	2"	2 1/2"	3"	4"	5"	6"
€	-	-	9,07	12,19	15,78	24,02	32,07	48,37	93,52	145,16	256,65	-	-
Box Cim 70 BS	-	-	10	5	5	5	4	2	2	2	1	-	-
Cart. Cim 70 BS	-	-	100	50	50	30	24	16	8	4	2	-	-

cim 70 BSCR



Vanne en alliage "CR" de type EN 12288/B (BS 5154/B) - PN 25 Válvula de compuerta de aleación "CR" tipo EN 12288/B - PN 25

LIC. N° KM 553179 - PN 25



LIC. N° WMKA01582 - PN 20

DN	1/4"	3/8"	1/2"	3/4"	1"	1 1/4"	1 1/2"	2"	2 1/2"	3"	4"	5"	6"
€	-	-	10,98	15,27	18,94	27,77	38,26	56,90	-	-	-	-	-
Box	-	-	10	5	5	5	4	2	-	-	-	-	-
Cart.	-	-	100	50	50	30	24	16	-	-	-	-	-

cim 50



Vanne de type compact - PN 16 / Válvula de compuerta tipo compacto - PN 16

CIM 50 NPT - FILETAGE NPT

CIM 50 NPT - ROSCA NPT

DN	1/4"	3/8"	1/2"	3/4"	1"	1 1/4"	1 1/2"	2"	2 1/2"	3"	4"	5"	6"
€	-	-	7,17	8,23	10,94	14,43	19,47	29,52	54,93	79,47	136,29	-	-
Box	-	-	40	35	25	16	10	10	2	2	2	-	-
Cart.	-	-	160	140	100	64	40	20	12	8	4	-	-

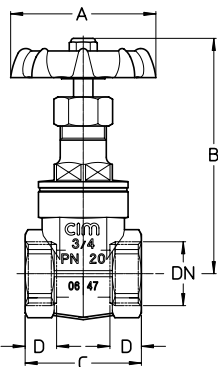

DN	1/4"	3/8"	1/2"	3/4"	1"	1 1/4"	1 1/2"	2"	2 1/2"	3"	4"	5"	6"
Cim 70B	Grms. 210	195	250	390	520	720	990	1440	2400	3455	5875	10605	14200
A	50	50	55	60	65	75	80	90	110	120	140	175	175
B	71	72	81	95,5	105	120,5	135	149	186	206,5	263	318	358
C	40	40	44	48	54	60	64	72	80	85	97	112	122
D	11	11	12	14	15	17	17	20,5	21	22	23,5	28	26
Cim 70BS	Grms. -	-	280	400	545	830	1240	1850	3455	5090	8825	-	-
A	-	-	55	60	65	75	80	90	120	140	175	-	-
B	-	-	81	97	107,5	121,5	142	165,5	212	250	296,5	-	-
C	-	-	44	48	55	61	65	71	92	98	107	-	-
D	-	-	12	13	15,5	16,5	18	19	24	26	28	-	-
Cim 70BSCR	Grms. -	-	295	445	615	925	1310	1895	-	-	-	-	-
A	-	-	55	60	65	75	80	90	-	-	-	-	-
B	-	-	80	96,5	107,5	121,5	142	165,5	-	-	-	-	-
C	-	-	54	59	66	74	75	86	-	-	-	-	-
D	-	-	17	18,5	21	23	23	27,5	-	-	-	-	-
Cim 50	Grms. -	-	210	255	365	510	695	1120	2065	2835	4960	-	-
Cim 50 NPT	A	-	50	55	60	65	65	80	110	110	120	-	-
B	-	-	79	82,5	95,5	103	115,5	139	181,5	201	239,5	-	-
C	-	-	42	46	50	55	60	67	69	77	91	-	-
D	-	-	11,5	12	14	16	17	18	14,5	19	21	-	-

cim 70 NPT



Vanne de type standard - FILETAGE NPT - 250 WOG - PN 20
 Válvula de compuerta tipo estándar - ROSCA NPT - 250 WOG - PN 20

DN	1/4"	3/8"	1/2"	3/4"	1"	1 1/4"	1 1/2"	2"	2 1/2"	3"	4"	5"	6"
€	7,45	7,45	8,21	11,15	14,72	20,79	34,87	41,67	63,64	87,60	183,92	422,66	561,60
Box	50	50	35	25	16	10	8	5	2	2	2	1	-
Cart.	100	100	140	100	64	40	32	20	12	8	4	2	2

cim 72 F



Vanne à bride - en bronze - PN 16
 Válvula de compuerta bridada - de bronce - PN 16

DN	1/2"	3/4"	1"	1 1/4"	1 1/2"	2"	2 1/4"	2 1/2"	3"	4"	PN 10	
											5"	6"
mm.	15	20	25	32	40	50	60	70	80	100	125	150
€	64,85	81,13	110,72	151,86	179,52	217,58	293,43	320,49	427,63	621,89	943,09	1.221,61
Box	1	1	1	1	1	1	1	1	1	1	1	1

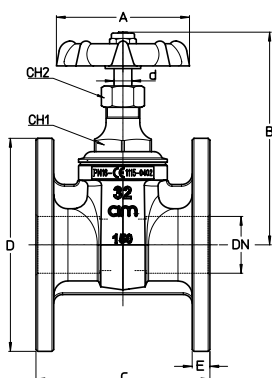

	DN	1/4"	3/8"	1/2"	3/4"	1"	1 1/4"	1 1/2"	2"	2 1/4"	2 1/2"	3"	4"	5"	6"
Cim 70 NPT	Grms.	205	190	245	420	540	770	980	1490	-	2405	3490	5960	10100	13770
	A	50	50	55	60	65	75	80	90	-	110	120	140	175	175
	B	71	72	81	95,5	105	120,5	135	149	-	186	206,5	263	318	358
	C	40	40	44	48	54	60	64	72	-	80	85	97	112	122
	D	11	11	12	14	15	17	17	20,5	-	21	22	23,5	28	26
Cim 72 F	Ø mm.	-	-	15	20	25	32	40	50	60	70	80	100	125	150
	Grms.	-	-	1150	1660	2440	3180	4170	5130	6720	6540	10130	15060	22540	29800
	A	-	-	55	60	65	75	80	90	90	110	120	140	175	175
	B	-	-	84	96,5	104	120,5	135	148,5	173	185,5	206	264	316,5	361
	C	-	-	69	84,5	89	97,5	113	124	141	153,5	158	169,5	191	209,5
	D	-	-	95	105	119	138,5	147	165	175	183,5	199	229	256	285
	E	-	-	8,5	9	9,5	10	10,5	9	12	12	12	14	16	18
	CH1	-	-	24	30	32	32	39	47	49	55	66	84	114	134
	CH2	-	-	18	18	18	21	23	25	25	30	30	37	45	50
	d	-	-	8	8	8	10	10	12	12	13	14	17	19	21

TABLEAU DES BRIDES / TABLA DE BRIDAS

DN	mm.	PN 6				PN 10				PN 16			
		Ø extérieur Ø exterior	nbr d'orifices nº orificios	Ø orifices Ø orificios	ligne médiane línea central Ø	Ø extérieur Ø exterior	nbr d'orifices nº orificios	Ø orifices Ø orificios	ligne médiane línea central Ø	Ø extérieur Ø exterior	nbr d'orifices nº orificios	Ø orifices Ø orificios	ligne médiane línea central Ø
1/2"	15	80	4	12	55	95	4	14	65	95	4	14	65
3/4"	20	90	4	12	65	105	4	14	75	105	4	14	75
1"	25	100	4	12	75	115	4	14	85	115	4	14	85
1 1/4"	32	120	4	14	90	140	4	18	100	140	4	18	100
1 1/2"	40	130	4	14	100	150	4	18	110	150	4	18	110
2"	50	140	4	14	110	165	4	18	125	165	4	18	125
2 1/2"	70	160	4	14	130	185	4	18	145	185	4	18	145
3"	80	190	4	18	150	200	4	18	160	200	8	18	160
4"	100	210	4	18	170	220	4	18	180	220	8	18	180
5"	125	240	8	18	200	250	8	18	210	250	8	18	210
6"	150	265	8	18	225	285	8	22	240	285	8	22	240

cim 75



Soupape d'arrêt à siège métallique Válvula de globo de asiento metálico

Cim 75 - PN 16 - bronze / bronce					Cim 75L - PN 10 - laiton / latón					
DN	3/8"	1/2"	3/4"	1"	1 1/4"	1 1/2"	2"	2 1/2"	3"	4"
€ Cim 75	-	14,16	20,45	29,91	42,94	52,00	78,01	172,62	222,09	437,71
Box	-	35	25	16	8	6	4	2	1	1
Cart.	-	140	100	64	32	24	16	6	4	2
€ Cim 75 L	-	12,83	16,36	24,15	34,36	45,86	63,65	-	-	-

cim 75 L



cim 81



Soupapes d'arrêt en bronze à siège en PTFE Válvula de globo de bronce y asiento de P.T.F.E.

Cim 81 - PN 20					Cim 81 L - PN 16					
DN	3/8"	1/2"	3/4"	1"	1 1/4"	1 1/2"	2"	2 1/2"	3"	4"
€ Cim 81	18,40	20,79	28,16	42,26	49,06	74,39	125,29	-	-	-
Box	30 / -	25/35	18/25	10/16	8/8	4/6	2/4	Box - Cart. Cim 81L voir Cim 75		
Cart.	120 / -	100/140	72/100	40/64	32/32	16/24	8/16	see Cim 75		
€ Cim 81 L	-	17,30	22,33	30,89	44,73	54,08	83,03	179,88	241,99	439,76

cim 81 L



cim 78



Soupape de retenue - en bronze - siège métallique - PN 16 Válvula de retención - de bronce - asiento metálico - PN 16

DN	3/8"	1/2"	3/4"	1"	1 1/4"	1 1/2"	2"	2 1/2"	3"	4"
€	-	11,43	16,86	24,51	34,75	41,96	68,52	131,16	171,37	329,84
Box	-	50	50	30	15	12	6	4	2	1
Cart.	-	100	100	60	30	24	12	8	4	2

cim 79 A



Soupape de retenue - en bronze - siège en PTFE - PN 20 Válvula de retención - de bronce - asiento de P.T.F.E. - PN 20

DN	3/8"	1/2"	3/4"	1"	1 1/4"	1 1/2"	2"	2 1/2"	3"	4"
€	14,16	16,03	22,20	37,75	44,53	63,51	108,55	150,24	201,63	359,97
Box	50	50	25	15	12	6	4	4	2	1
Cart.	100	100	50	30	24	12	8	8	4	2

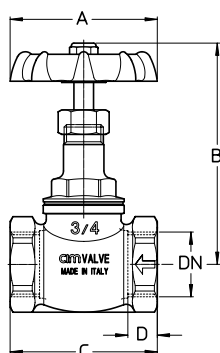

	Cim 75					Cim 75 L					Cim 81					Cim 81 L					Cim 78					Cim 79 A								
DN	Grms.	A	B	C	D	Grms.	A	B	C	D	Grms.	A	B	C	D	Grms.	A	B	C	D	Grms.	A	B	C	D	Grms.	A	B	C	D				
3/8"	-	-	-	-	-	-	-	-	-	-	320	55	87,5	58	11	-	-	-	-	-	-	-	-	-	-	-	-	-	-	235	-	32,5	58	11
1/2"	295	55	78	50	11	211	55	65	48	8	380	55	87,5	60	12	300	55	77,5	50	11	220	-	30	50	11	280	-	35,5	60	12				
3/4"	440	60	89	60	12	273	60	67	53	9	620	60	98,5	70	12	425	60	88	60	12	335	-	35	60	12	450	-	40	70	12				
1"	635	65	100	70	13,5	437	65	82	63	10	900	65	112,5	84	14	600	65	98	70	14	510	-	41	70	14	775	-	49	84	14				
1 1/4"	980	65	116	84	15,5	665	80	93	73	12	1130	75	132	92	17	930	65	111	84	15,5	840	-	49	85	16	985	-	55,5	92	17				
1 1/2"	1280	75	130	90	16	956	80	114	81	12	1640	80	138,5	107	18	1250	75	130,5	90	16	1035	-	56	90	16	1500	-	60,5	107	18				
2"	1900	80	143,5	110	18	1356	90	134	94	15	3000	90	155	126	19	1850	80	139	110	18	1730	-	63	110	18	2550	-	71,5	126	19				
2 1/2"	3930	120	200	135	23,5	-	-	-	-	-	-	-	-	-	-	4000	120	209	135	23,5	3300	-	73,5	135	23	3455	-	73,5	135	23				
3"	5055	120	223	148	24	-	-	-	-	-	-	-	-	-	-	5350	120	234,5	148	24	4250	-	88	148	22	4350	-	88	148	22				
4"	10500	175	281	189	22	-	-	-	-	-	-	-	-	-	-	10200	175	289	189	22	8500	-	110	190	23	8850	-	110	190	23				

cim 76



Soupape d'arrêt à bride - en bronze - siège métallique - PN 16
Válvula de globo bridada - de bronce - asiento metálico - PN 16

DN	1/2"	3/4"	1"	1 1/4"	1 1/2"	2"	2 1/2"	3"	4"
mm.	15	20	25	32	40	50	70	80	100
€	64,32	83,15	122,41	154,81	204,66	263,17	443,81	554,05	867,35

cim 82



Soupape d'arrêt à bride - en bronze - siège en PTFE - PN 16
Válvula de globo bridada - de bronce - asiento de P.T.F.E. - PN 16

DN	1/2"	3/4"	1"	1 1/4"	1 1/2"	2"	2 1/2"	3"	4"
mm.	15	20	25	32	40	50	70	80	100
€	66,42	84,42	125,01	158,72	209,19	277,08	487,13	609,25	904,69

cim 77



Soupape de retenue à bride - en bronze - siège métallique - PN 16
Válvula de retención bridada - de bronce - asiento metálico - PN 16

DN	1/2"	3/4"	1"	1 1/4"	1 1/2"	2"	2 1/2"	3"	4"
mm.	15	20	25	32	40	50	70	80	100
€	58,88	84,84	106,99	147,98	191,53	243,71	403,62	506,17	776,88

cim 79



Soupape de retenue à bride - en bronze - siège en PTFE - PN 16
Válvula de retención bridada - de bronce - asiento de P.T.F.E. - PN 16

DN	1/2"	3/4"	1"	1 1/4"	1 1/2"	2"	2 1/2"	3"	4"
mm.	15	20	25	32	40	50	70	80	100
€	61,03	82,04	107,86	156,31	197,94	253,58	403,62	506,17	776,88

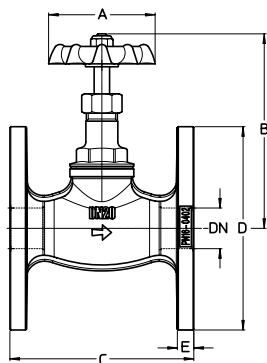

DN	mm.	Cim 76						Cim 82					Cim 77 - Cim 79					
		Grms.	A	B	C	D	E	Grms.	A	B	C	D	E	Grms.	B	C	D	E
1/2"	15	1380	55	92,5	82,5	94	8	1375	55	97,5	82,5	94	8	1225	35	84	80	8,5
3/4"	20	1710	55	100	95	105	8	1705	55	104,5	95	105	8	1655	41,5	95	105	8,5
1"	25	2350	65	111	104	119	10	2325	65	109	104	119	10	2340	46,5	105	120	10
1 1/4"	32	3350	65	113,5	113	138,5	10	3320	65	112,5	113	138,5	10	3450	53	114	140	10
1 1/2"	40	4580	80	145	133,5	147	11	4525	80	138,5	133,5	147	11	4445	60,5	134	150	11
2"	50	5930	80	155	154	163	11	5850	80	152,5	154	163	11	5765	69,5	154	164	11
2 1/2"	70	9010	120	199	170	185	13	8885	120	208	170	185	13	8075	73	170	185	13
3"	80	11650	120	226	180	200	13	11535	120	235,5	178,5	199	13	10300	90	180	200	13
4"	110	18110	175	287,5	200	230	17	17910	175	297	200	230	17	16185	110	200	230	17

cim 80



Clapet de retenue - siège métallique - PN 16 Válvula de retención a clapeta - asiento metálico - PN 16

LAITON FONDU CC7545

LATÓN FUNDIDO CC7545

DN	1/2"	3/4"	1"	1 1/4"	1 1/2"	2"	2 1/2"	3"	4"
€	8,35	12,09	17,30	24,06	32,64	42,46	73,50	97,44	163,90
Box	50	25	20	12	10	5	4	2	2
Cart.	200	100	80	48	40	20	16	8	4

cim 80 A



Clapet de retenue - siège en caoutchouc - PN 16 Válvula de retención a clapeta - asiento de goma - PN 16

LAITON FONDU CC7545

LATÓN FUNDIDO CC7545

DN	1/2"	3/4"	1"	1 1/4"	1 1/2"	2"	2 1/2"	3"	4"
€	9,16	13,27	18,44	25,30	35,28	45,20	78,62	100,19	176,80
Box	50	25	20	12	10	5	4	2	2
Cart.	200	100	80	48	40	20	16	8	4

cim 95



Crépine à clapet avec tige à double guide - PN 16 Válvula de fondo con filtro - PN 16

LAITON FONDU CC7545 - LATÓN FUNDIDO CC7545

BRONZE
BRONCE

DN	1/2"	3/4"	1"	1 1/4"	1 1/2"	2"	2 1/2"	3"	4"	5"	6"
€	10,69	12,71	15,07	20,12	25,30	35,51	57,27	77,28	145,93	493,61	609,82
Box	50	40	24	15	12	7	3	2	2	1	1
Cart.	200	160	96	60	48	28	12	8	4	2	1

cim 95 A



Crépine à clapet obturateur anti-sable - PN 16 Válvula de fondo cilíndrica - PN 16

CRÉPINE INOX DE 1/2" À 1 1/2"
LAITON DE 2" À 4"

LAITON FORJÉ CW617N-M
LATÓN FORJADO CW617N-M

FILTRO INOXIDABLE DE 1/2" A 1 1/2"
LATÓN DE 2" A 4"

DN	1/2"	3/4"	1"	1 1/4"	1 1/2"	2"	2 1/2"	3"	4"	5"	6"
€	9,54	12,42	17,93	21,12	27,33	39,90	64,81	88,94	167,83	-	-
Box	50	50	30	15	10	7	2	2	2	-	-
Cart.	200	200	120	60	40	28	12	12	4	-	-

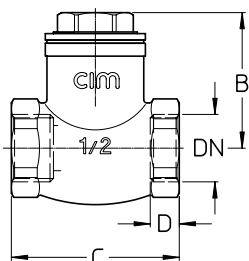

	Cim 80 - Cim 80 A				Cim 80				Cim 80 A				Cim 95				Cim 95 A			
DN	Grms.	B	C	D	O	V	O	V	Grms.	B	C	D	Grms.	B	C	D	Grms.	B	C	D
1/2"	245	42,5	52	13	0,7	11	0,7	11	185	63,5	39	11,5	135	97	26	10				
3/4"	350	46	62	15	0,7	9	0,7	9	270	75	46	11,5	225	114,5	32	12				
1"	500	53	70	14	0,7	9	0,7	9	390	87	55	12	325	130,5	38	13				
1 1/4"	740	61	84	18,5	0,7	8	0,7	8	505	96,5	64	14	480	146	47	15				
1 1/2"	900	64,5	87	15,5	0,7	8	0,7	8	640	105	69	14	665	168	54	15				
2"	1500	70	106	20	0,7	9	0,7	9	1040	117,5	87	15,5	1230	173	65	22				
2 1/2"	2250	84	120,5	24	0,4	9	0,4	9	1895	146	108	17	2110	208	83	20				
3"	3300	90	136	31,5	0,4	9	0,4	9	2440	159,5	126	17,5	3015	227,5	95	20				
4"	5850	113	170	24,5	0,5	9	0,5	9	4920	207,5	167	19,5	4985	259	123	24				
5"	-	-	-	-	Pres. ouvert. obturateur mbar O = inst. horiz. - V = inst. vert.				11905	287,5	200	22	-	-	-	-				
6"	-	-	-	-	Pres. apert. obturador mbar O = inst. horiz. - V = inst. vert.				15220	334,5	235	25	-	-	-	-				

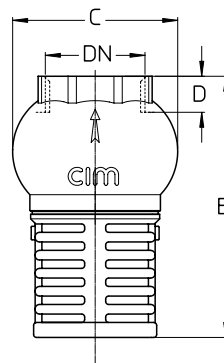

cim 30



Clapet de retenue "SPRINT" avec obturateur à ressort - PN 20
Válvula de retención "SPRINT" con obturador de muelle - PN 20

DN	3/8"	1/2"	3/4"	1"	1 1/4"	1 1/2"	2"	2 1/2"	3"	4"
€	5,87	5,87	8,32	12,51	17,77	26,57	35,93	75,75	103,26	177,84
Box	50	50	25	20	12	8	5	4	3	2
Cart.	200	200	100	80	48	32	20	12	6	4

cim 30 DK



Clapet de retenue "SPRINT" pour hydrocarbures - PN 20
Válvula de retención "SPRINT" para hidrocarburos - PN 20

DN	3/8"	1/2"	3/4"	1"	1 1/4"	1 1/2"	2"	2 1/2"	3"	4"
€	7,77	7,77	10,82	15,78	23,96	34,32	47,06	93,70	129,11	227,68
Box	50	50	25	20	12	8	5	4	3	2
Cart.	200	200	100	80	48	32	20	12	6	4

cim 30 VA



Clapet de retenue "SPRINT" pour vapeur - 4 BARS - 150°C
Válvula de retención "SPRINT" para vapor - 4 bares - 150°C

DN	3/8"	1/2"	3/4"	1"	1 1/4"	1 1/2"	2"	2 1/2"	3"	4"
€	8,96	8,96	12,45	17,97	27,66	40,34	54,18	97,56	136,86	228,23
Box	50	50	25	20	12	8	5	4	3	2
Cart.	200	200	100	80	48	32	20	12	6	4

cim 30 CRNL



Clapet de retenue "SPRINT" en alliage "CR" CW511-L SANS PLOMB avec obturateur à ressort - PN 20
Válvula de retención "SPRINT" de aleación "CR" CW511-L SIN PLOMO con obturador de muelle - PN 20

DN	3/8"	1/2"	3/4"	1"	1 1/4"	1 1/2"	2"	2 1/2"	3"	4"
€	-	7,06	9,99	15,00	21,33	31,88	43,11	-	-	-
Box	-	50	25	20	12	8	5	-	-	-
Cart.	-	200	100	80	48	32	20	-	-	-

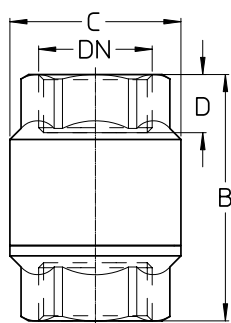

Cim 30 - Cim 30 DK - Cim 30 VA - Cim 30 CRNL				
DN	Grms.	B	C	D
3/8"	210	55,5	35	13
1/2"	160	55,5	35	14
3/4"	240	62	42	14,5
1"	380	72	50	17
1 1/4"	600	82	60	18
1 1/2"	920	96	70	22
2"	1360	109	83	23
2 1/2"	2505	129	103	29
3"	3440	141	123	28
4"	5115	146	160	30

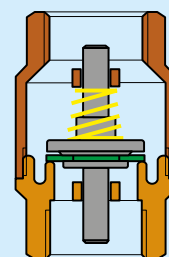

L'obturateur à ressort s'ouvre et se soulève à une pression de 25 mbar (0,36 psi)
El obturador de muelle se abre y se levanta a una presión de 25 mbares (0,36 psi)

Obturateur / Obturador: Joint obturat. / Guarn. obt.:
Cim 30: HOSTAFORM EPDM
Cim 30/DK: HOSTAFORM FKM
Cim 30/VA: PPS EPDM PEROX
Cim 30/CRNL: HOSTAFORM EPDM

cim 32



Clapet de retenue avec obturateur à ressort - PN 16 Válvula de retención con obturador de muelle - PN 16

	MÂLE/FEMELLE			MACHO/HEMBRA		
DN	1/2"	3/4"	1"	1 1/4"	1 1/2"	2"
€	5,30	7,12	11,07	16,86	25,87	34,02
Box	50	50	25	15	10	8
Cart.	200	200	100	60	40	32

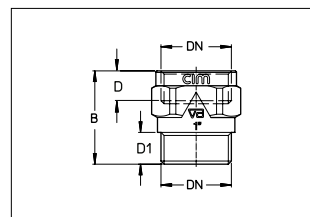

Clapets de non-retour antipollution contrôlable Válvulas de retención anticontaminación controlables

Le clapet de non-retour **CIM33CREA** ANTIPOLLUTION CONTRÔLABLE est fabriqué conformément à la norme européenne EN 1717. Cette norme traite de la méthode à suivre pour protéger l'eau destinée à la consommation contre la pollution par retour. Le système d'approvisionnement est protégé par des composants fabriqués dans des matériaux adaptés à l'eau potable, qui le protègent contre les influences des réseaux extérieurs, évitent les stagnations et permettent l'inspection des composants contrôlables.

La válvula de retención **CIM33CREA** ANTICONTAMINACIÓN CONTROLABLE se fabrica conforme a la norma europea EN 1717. Esta norma establece el método que se debe emplear para proteger el agua destinada al consumo humano contra el riesgo de contaminación por reflujos. El sistema de abastecimiento se protege utilizando componentes fabricados con materiales compatibles para el contacto con el agua potable, protegiéndolo de la influencia de redes exteriores, evitando estancamientos y permitiendo inspeccionar los componentes controlables.

cim 33 CREA

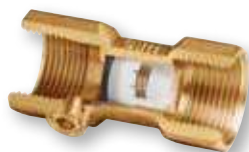

Clapet de non-retour antipollution contrôlable alliage laiton "CR" - PN 16 Válvula de retención anticontaminación controlable de aleación de latón "CR" - PN 16

	FEMELLE/FEMELLE			HEMBRA/HEMBRA		
DN	1/2"	3/4"	1"	1 1/4"	1 1/2"	2"
€	9,13	12,53	17,25	24,38	35,03	49,89
Box	40	24	20	20	15	10
Cart.	160	96	80	80	60	40

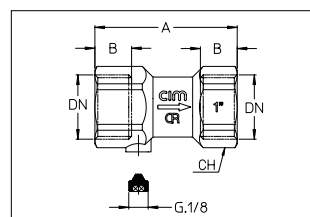

cim 33 CREARB



Clapet de non-retour antipollution contrôlable alliage laiton "CR" - PN 16 Válvula de retención anticontaminación controlable de aleación de latón "CR" - PN 16

	RACCORDMENT BICÔNE		RACOR CON BICONO	
mm.	15x15	22x22	28x28	
€	12,36	16,74	23,92	
Box	25	20	12	
Cart.	100	80	48	

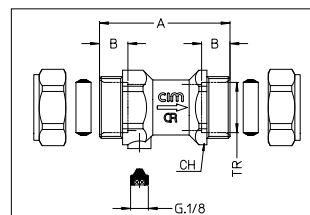

Fabriqué en laiton non dézincifiable "CR", il est adapté à une installation verticale, horizontale ou à siège incliné pour permettre le débit dans une seule direction. Il s'ouvre automatiquement quand la pression de l'écoulement en amont du clapet est supérieure à l'aval. Au cas où la pression est supérieure en aval ou sans écoulement, le clapet se ferme d'avance sous l'action d'un ressort.

L'obturateur à ressort est certifié par KIWA, WRC, NF, DVGW.
Pression d'ouverture 20 mbar. Température d'utilisation de -10° à 110°C.

Se fabrica en latón resistente a la des zincificación "CR" y es apta para la instalación vertical, horizontal y oblicua para permitir el flujo en una sola dirección. Se abre automáticamente cuando la presión en la dirección del flujo aguas arriba de la válvula es mayor que la presión aguas abajo de la válvula. Si la presión es mayor arriba o en caso de ausencia de flujo, la válvula se cierra por adelantado bajo la acción de un muelle.

El obturador de muelle ha sido aprobado por KIWA, WRC, NF, DVGW.
Presión de apertura: 20 bares. Temperatura de trabajo: de -10°C a 110°C.

Cim 32						Cim 33 CREA					Cim 33 CREARB				
DN	DN	Grms.	B	D	D1	Filett.	Grms.	A	B	CH	mm.	Grms.	A	B	CH
1/2"	1/2"	50	33	13,5	14,5	ISO 7/1	115	59,5	17	25	15x15	174	59,5	13	25
3/4"	3/4"	95	38	13,5	14,5		173	67	18,5	31	22x22	249	67	15	32
1"	1"	160	44	15	15,5		271	78	21	38	28x28	400	78	16	38
1 1/4"	1 1/4"	260	49	17	17	ISO 228	350	76	17	47	35x35	-	-	-	-
1 1/2"	1 1/2"	360	57	19	19		510	86	19	54	42x42	-	-	-	-
2"	2"	715	75	22	20		780	102	20	66	54x54	-	-	-	-

Pression d'ouverture de l'obturateur:
10 mbar
Presión de apertura del obturador:
10 bares

- Corps / Cuerpo EN 12165 CW602N
- Siège / Asiento POM
- Clapet / Válvula POM
- Guide / Guía POM
- Joint / Guarnición NBR
- Ressort / Muelle STAINLESS STEEL 18/8
- O-Ring / O-ring NBR
- Bouchon / Tapón EN 12165 CW602



cim 74 ACRNL



Filtre à siège incliné en alliage "CR" CW511-L SANS PLOMB - PN 20
Filtro "Y" oblicuo de aleación "CR" CW511-L SIN PLOMO - PN 20

"CR"-SCC - RÉSISTANTE À LA DÉZINCIFICATION ET À LA CORROSION SOUS TENSION

"CR"-SCC - RESISTENTE A LA DESZINCIFICACIÓN Y CORROSIÓN BAJO TENSION

BRONZE / BRONCE

DN	3/8"	1/2"	3/4"	1"	1 1/4"	1 1/2"	2"	2 1/2"	3"	4"
€ Cim 74 ACRNL tamis 0,65 mm.	8,09	9,09	12,17	18,63	27,93	34,12	59,80	112,50	170,75	320,17
Box	50	50	30	20	12	10	4	4	1	1
Cart.	200	200	120	80	48	40	16	8	6	2
€ Cim 74 AGCRNL tamis 0,25 mm.	9,39	10,50	13,93	20,92	31,38	38,79	67,27	-	-	-

cim 74 ACR



Filtre à siège incliné en alliage de laiton "CR" CW602N - PN 20
Filtro "Y" oblicuo de aleación "CR" CW602N - PN 20

DN	3/8"	1/2"	3/4"	1"	1 1/4"	1 1/2"	2"	F=0,65 mm. F=0,25 mm.	F=650 µm F=250 µm				
€ Cim 74 ACR tamis 0,65 mm.	-	8,74	11,68	17,89	26,80	32,75	57,99		<table border="1"> <tr> <th>Mesh / Malla</th> <th>N° orif. cm²</th> </tr> <tr> <td>30/60</td> <td>52/280</td> </tr> </table>	Mesh / Malla	N° orif. cm²	30/60	52/280
Mesh / Malla	N° orif. cm²												
30/60	52/280												
Box	-	50	30	20	10	8	4						
Cart.	-	200	120	80	40	32	16						
€ Cim 74 AGCR tamis 0,25 mm.	-	10,12	13,38	20,17	30,27	37,42	65,50						

cim 74 AOT



Filtre à siège incliné en alliage de laiton CW617N-M - PN 20
Filtro "Y" oblicuo de aleación "CR" CW617N-M - PN 20

DN	3/8"	1/2"	3/4"	1"	1 1/4"	1 1/2"	2"	De DN 1/2" à DN 1 1/4" le filetage du bouchon est identique à celui des manchons, ex. 3/4" x 3/4" x 3/4"	
€ Cim 74 AOT tamis 0,65 mm.	-	5,55	8,09	12,08	18,61	24,13	45,28	Del DN 1/2" al DN 1 1/4", la rosca del tapón es la misma que la de los manguitos, ej. 3/4" x 3/4" x 3/4"	
Box	-	50	30	20	10	8	4		
Cart.	-	200	120	80	40	32	16		
€ Cim 74 AGOT tamis 0,25 mm.	-	6,78	9,40	14,02	28,04	28,31	53,13		

cim 74 ACRNL/1



Filtre à siège incliné en alliage "CR" CW511-L SANS PLOMB - PN 20
Filtro "Y" oblicuo de aleación "CR" CW511-L SIN PLOMO - PN 20

AVEC BOUCHON DE PURGE CON TAPON DE DESCARGA

AVEC ROBINET DE PURGE CON VÁLVULA DE DESCARGA

DN	1/2"	3/4"	1"	1 1/4"	1 1/2"	2"
€ Cim 74 ACRNL/1 tamis 0,65 mm.	10,66	14,10	21,54	30,85	37,03	62,73
Box Cim 74 ACRNL/1	50	30	20	12	10	4
€ Cim 74 ACRNL/2 tamis 0,65 mm.	16,87	20,33	23,60	36,48	42,66	68,35
Box Cim 74 ACRNL/2	50	30	20	12	10	4

cim 74 ACRNL/2



DN	Cim 74 ACRNL Cim 74 ACRNL/5					Cim 74 ACR Cim 74 ACR/5					Cim 74 ACRNL/1 Cim 74 ACRNL/2					Cim 74 AOT Cim 74 AOT/5						
	Grms.	A	B	C	D	Grms.	A	B	C	D	Grms.	A	B	C	D	F	Grms.	A	B	C	D	
3/8"	190	38	51	55	10	-	-	-	-	-	-	-	-	-	-	-	-	-	-	-	-	-
1/2"	220	40	56	59	12	210	39	55	68	16,5	230	40,5	56,5	59	12	G. 1/4"	148	38,5	52	59	12	
3/4"	325	47	66	68	12,5	315	50	69	77	18	355	47,5	66,5	68	12,5	G. 1/4"	232	47,5	65	68	12,5	
1"	481	59	82	76	13,5	455	60	82	91	21	385	59	82	76	13,5	G. 3/8"	341	57,5	78	76	13,5	
1 1/4"	772	72	100,5	92	15	760	73	104,5	108	23	815	72	100,5	92	16	G. 3/8"	553	70,5	95,5	92	16	
1 1/2"	1003	80	112	100	16	975	82	113	116	23	955	80	112	100	16	G. 3/8"	712	78	106,5	100	16	
2"	1777	98,5	138	125	19	1825	99	139	143	28	1790	98,5	138	125	19	G. 3/8"	1299	98	133	125	19	
2 1/2"	2620	114	163	148	22	FILTRES: tamis en acier inoxydable 18/8 - 0,65 mm. recommandé pour l'eau - 0,25 mm. recommandé pour le gaz Joint d'étanchéité entre le corps et le bouchon: joint torique (O-ring) FKM 70 Rouge -20°C +200°C FILTROS: red de acero inoxidable 18/8 - 0,65 mm. recomendado para agua - 0,25 mm. recomendado para gas Junta de estanqueidad entre cuerpo y tapón: O-ring FKM 70 Red -20°C +200°C																
3"	4200	137	195	175	24																	
4"	7550	167	240,5	217	25																	

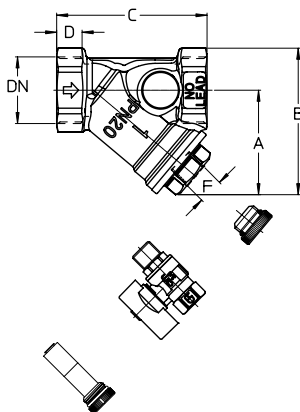

cim 787

Vanne d'équilibrage à orifice variable Válvula de equilibrio de orificio variable

cim 787



cim 787PRS



UTILISATIONS: les vannes d'équilibrage **Cim 787** conviennent pour les installations de chauffage (LPHW) et de refroidissement. Elles sont disponibles en laiton non dézincifiable "CR" (**Cim 787**) ou en laiton standard (**Cim 787OT**).

Les caractéristiques principales des vannes d'équilibrage **Cim 787** sont les suivantes:

- Un système de blocage automatique qui permet de fixer la position de la vanne précisément, en donnant la possibilité de l'ouvrir ou fermer à nouveau dans la même position souhaitée;
- Clé Allen pour le blocage des positions de la vanne;
- Une échelle indicatrice de la position de la vanne, lisible de n'importe quel côté;
- Obturateur avec joint en EPDM pour assurer une étanchéité parfaite
- Classe de pression: PN 25 - Température: -10°C ÷ 120°C

Sur demande, cette vanne est disponible avec raccordement par sertissage (**Cim 787PRS** - **Cim 787OTPRS**).

APLICACIONES: Las válvulas de equilibrio **Cim 787** son adecuadas para instalaciones tanto de calefacción (LPHW) como de climatización. Están disponibles en latón "CR" (**Cim 787**) o en latón estándar (**Cim 787OT**).

Las válvulas de equilibrio **Cim 787** tienen las siguientes características principales:

- Un sistema de bloqueo mecánico permite establecer las posiciones de la válvula, la cual se puede cerrar y volver a abrir en la posición prefijada exacta;
- Llave Allen para bloquear las posiciones de la válvula;
- Una escala graduada visible desde ambos lados que indica la posición;
- Obturador con guarnición EPDM que garantiza el cierre estanco;
- Clase de presión: PN25. Temperatura: de -10°C a 120°C.

Bajo pedido se suministran racores de presión (**Cim 787PRS** - **Cim 787OTPRS**).

DN	€		Grms.	A	B	C	C1	D	CH	Kvs
	Cim 787	Cim 787OT								
1/2"	33,75	31,45	380	50	87,5	77	106	17	25	1,75
3/4"	35,95	33,40	440	50	89,5	80	107	18,5	31	2,87
1"	40,20	36,85	535	50	91,5	87	107	21	38	4,08
1 1/4"	64,00	56,85	960	50	99	108	123	22,5	48	6,71
1 1/2"	80,85	71,65	1120	50	99	115	129	23	55	10,40
2"	101,65	89,30	1350	50	100	124	132	26,5	66	15,06

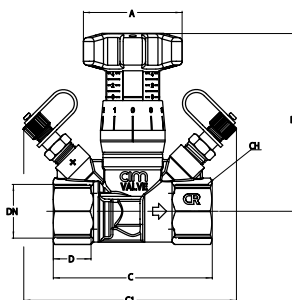

cim 788

Vanne d'équilibrage pré-réglable Válvula de equilibrio preajustable

cim 788



cim 788-4

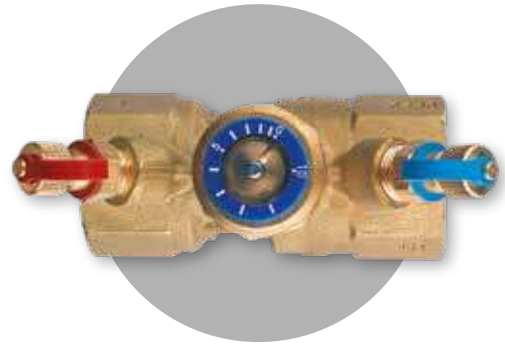

UTILISATIONS: les vannes d'équilibrage **Cim 788** conviennent soit pour les installations de chauffage (LPHW) que de refroidissement. Elles sont disponibles en laiton "CR" (**Cim 788**) ou en laiton standard (**Cim 788OT**).

Les caractéristiques principales des vannes d'équilibrage **Cim 788** pré-réglable sont les suivantes:

- Préréglage par tournevis;
- 11 positions pré-réglages du débit;
- Capuchon en plastique pour la fermeture et ouverture de la vanne dans la position souhaitée;
- Projetée pour être équipée avec actionneur thermoélectrique;
- Une fermeture étanche assurée par le clapet avec joint EPDM en cas de besoin d'isolation;
- Classe de pression: PN 25 - Température: -10°C ÷ 120°C;
- **Cim 788-4** assure un Δp plus haute dans les limites d'utilisation de la vanne avec actionneur thermoélectrique.

APLICACIONES: las válvulas de equilibrio **Cim 788** son adecuadas para instalaciones tanto de calefacción (LPHW) como de climatización. Están disponibles en latón "CR" (**Cim 788**) o en latón estándar (**Cim 788OT**).

Las válvulas de equilibrio **Cim 788** tienen las siguientes características principales:

- Regulación por medio de destornillador;
- 11 preajustes;
- Capuchón de plástico para abrir y cerrar la válvula en la posición prefijada;
- Diseñada para ser equipada con un actuador termoeléctrico;
- Obturador con guarnición EPDM que garantiza el cierre estanco;
- Clase de presión: PN25. Temperatura: de -10°C a 120°C;
- **Cim 788-4** garantiza un mayor Δp en el rango de utilización de la válvula con actuador termoeléctrico.

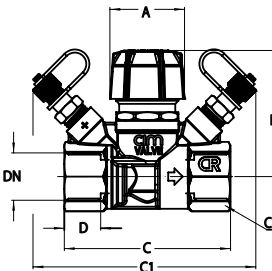
	DN	€ Cim 788	€ Cim 788OT	Grms.	A	B	C	C1	D	CH	Kv-Kvs Δp 2.2	Kv-Kvs Δp 4
	1/2"	40,75	38,40	350	35	58	77	106	15	25	1,70	1,64
3/4"	43,40	40,85	410	35	60	80	107	18,5	31	2,90	2,70	
1"	48,85	45,50	505	35	62	87	107	21	38	3,50	3,20	

Actionneurs thermoélectriques

Actuadores termoeléctricos

Les vannes d'équilibrage pré réglables Cim 788 peuvent être équipées avec actionneurs thermoélectriques.
Las válvulas de equilibrio preajustables Cim 788 se pueden equipar con los siguientes actuadores termoeléctricos.

cim EMV311/NC-NO 230 (230 VAC)

cim EMV311/NC-NO 24 (24 VAC)

Actionneur thermoélectrique pour l'ouverture et la fermeture des vannes dans les installations de chauffage et de refroidissement.

- Construction compacte, petites dimensions
- Protection totale contre les fuites
- Témoin de fonctionnement circulaire
- Haute longévité et sécurité de fonctionnement
- Faible puissance absorbée
- Position de montage 360°
- Repère pour le raccordement
- Sécurité grâce au coupe-circuit de surtension incorporée

Actuador termoeléctrico para la apertura y cierre de las válvulas en instalaciones de calefacción y refrigeración

- Estructura compacta, tamaño pequeño
- Protección total contra pérdidas
- Indicador de funcionamiento
- Funcionamiento seguro y de larga duración
- Consumo de potencia reducido
- Posición de instalación 360°
- Preparado para la conexión de la válvula

cim EMV310/PRO 24 (24 VAC)

Actionneur thermoélectrique avec unité interne électronique pour une commande proportionnelle des vannes en utilisant les systèmes de gestion intégrés.

- Mise au point de réglage
- Fonction "First open"
- Témoin de fonctionnement
- Version encliquetable
- Protection totale contre les fuites
- Commande proportionnelle
- Auto-calibrage
- Détecteur de position

Actuador termoeléctrico con unidad interna electrónica para controlar proporcionalmente las válvulas, utilizando los sistemas de gestión integrados.

- Puesta a punto de la regulación
- Función "primera apertura"
- Indicador de funcionamiento
- Montaje encajado
- Protección total contra pérdidas
- Mando proporcional
- Autocalibrado
- Indicador de posición



Cim EMV 311/NC 230	€ 40,45
Cim EMV 311/NC 24	€ 40,45
Cim EMV 311/NO 230	€ 40,45
Cim EMV 311/NO 24	€ 40,45

Cim EMV 310/PRO 24	€ 106,30
--------------------	----------

Actionneur thermoélectrique / Actuador termoeléctrico: Cim EMV 311/NC 230
Cim EMV 311/NC 24
Cim EMV 311/NO 230
Cim EMV 311/NO 24
Actionneur / Actuador
230V-24V NO - NC
230VAC - 24VAC
50/60 Hz
Tension de service / Tensión de alimentación: 2.5 W
Impédance d'entrée / Frecuencia: 1 m
Puissance de fonctionnement / Potencia: IP54
Longueur de câble / Longitud del cable: 200 grms
Classe de protection / Clase de protección: 160 N
Poids / Peso: 4 mm
Puissance / Fuerza del actuador: gris clair / gris

Actionneur thermoélectrique / Actuador termoeléctrico: Cim EMV 310/PRO 24
Actionneur proportionnel
Actuador proporcional
24V
Tension de service / Tensión de alimentación: -10% jusqu'à/hasta +20% 50/60 Hz
0-10 VDC
Tension de service / Tensión de alimentación: 100kOhm
Impédance d'entrée / Frecuencia: 1 W
Puissance de fonctionnement / Potencia: IP54/III
Classe de protection / Clase de protección: 4 mm
Distance de réglage / Carrera máxima: 100N±5%
Puissance / Fuerza del actuador: < 320 mA pour 2 min max.
Courant d'enclenchement / Corriente de inicio: < 320 mA durante máx. 2 minutos
Vitesse moyenne d'enclenchement / Velocidad media de func.: 30 s/mm
Câble de raccordement / Cable de conexión: 3x0,22 mm²
Longueur de câble / Longitud del cable: 1000 mm
Coloris de boîtier / Color de la caja del motor: blanc / blanco

cim 717

Vanne d'équilibrage avec contrôle indépendant de la pression (PICV) Válvula de equilibrio con control independiente de la presión (PICV)

cim 717LF
cim 717HF

cim 717PLF
cim 717PHF

DÉBIT BASSE CAUDAL BAJO	Cim 717LF - Cim 717PLF		
Dim./Tamaño	Débit/Caudal (l/h)	Débit/Caudal (l/s)	Débit/Caudal (gpm*)
1/2" DN 10	43 ÷ 150	0,0119 ÷ 0,0416	0,189 ÷ 0,659
3/4" DN 15	86 ÷ 347	0,0240 ÷ 0,0965	0,380 ÷ 1,530

* Les unités de mesure "gpm" correspondent à gallons US/minute
* Los valores "gpm" corresponden a un galón estadounidense por minuto

UTILISATIONS: Les vannes Cim 717 sont projetées pour l'équilibrage automatique des installations de chauffage (LPWH) et de refroidissement malgré les fluctuations de pression du système. Les vannes Cim 717 sont disponibles en laiton "CR".

Grâce à leur structure les vannes Cim 717 sont à même de réaliser trois fonctions différentes, en détail:

RÉGLAGE

Sélection du débit souhaité dans la gamme de fonctionnement;

CONTRÔLE

Garder le débit sélectionné malgré les fluctuations de pression;

MODULATION

Modulation du débit "full authority" par des actionneurs.

DÉBIT HAUTE CAUDAL BAJO	Cim 717HF - Cim 717PHF		
Dim./Tamaño	Débit/Caudal (l/h)	Débit/Caudal (l/s)	Flow (gpm*)
1/2" DN 10	86 ÷ 347	0,0240 ÷ 0,0965	0,380 ÷ 1,530
3/4" DN 15	96 ÷ 483	0,0266 ÷ 0,1341	0,422 ÷ 2,125
1" DN 20	180 ÷ 900	0,0500 ÷ 0,2500	0,792 ÷ 3,960
1 1/4" DN 25	340 ÷ 1700	0,094 ÷ 0,4720	1,496 ÷ 7,480

APLICACIONES: Las válvulas Cim 717 se han diseñado para equilibrar automáticamente las instalaciones de calefacción (LPHW) y de climatización con independencia de las fluctuaciones de presión. Las válvulas Cim 717 están disponibles en latón "CR".

Gracias a su estructura, las válvulas Cim 717 pueden desempeñar tres funciones diferentes. En concreto:

REGULACIÓN

Selección del caudal deseado dentro del rango de funcionamiento;

CONTROL

Mantenimiento del caudal seleccionado con independencia de las fluctuaciones de presión;

MODULACIÓN

Modulación del caudal "full authority" por medio de actuadores.

	DN	€ Cim 717LF Cim 717HF	€ Cim 717PLF Cim 717PHF	Grms.	A	B	B1	C	D	CH
	1/2"	100,50	93,60	450	35	75	130	53	9	38
3/4"	101,65	94,75	490	35	75	134	65	11	38	
1"	106,30	99,35	790	35	88	148	82	11	38	
1 1/4"	127,05	120,15	935	35	88	148	104	11	38	

Actionneurs thermoélectriques

Actuadores termoeléctricos

Les vannes d'équilibrage automatique Cim 795 peuvent être équipées avec les actionneurs thermoélectriques suivants

Las válvulas de equilibrio automáticas Cim 795 se pueden equipar con los siguientes actuadores termoeléctricos

cim EMV311/NC 230 (230 VAC EMV)
cim EMV311/NC 24 (24 VAC)

cim EMV311/NO 230 (230 VAC)
cim EMV311/NO 24 (24 VAC)

Cim EMV 311/NC 230	€ 40,45
Cim EMV 311/NC 24	€ 40,45
Cim EMV 311/NO 230	€ 40,45
Cim EMV 311/NO 24	€ 40,45

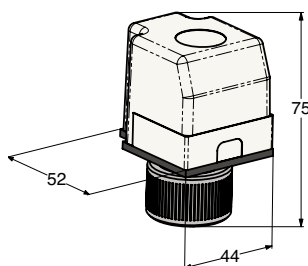

Actionneur thermoélectrique pour l'ouverture et la fermeture de vannes dans les circuits de distribution intégrés dans les systèmes de chauffage par le sol.

- Construction compacte, petites dimensions
- Protection totale contre les fuites
- Témoin de fonctionnement circulaire
- Haute longévité et sécurité de fonctionnement
- Faible puissance absorbée
- Position de montage 360°
- Repère pour le raccordement
- Sécurité grâce au coupe-circuit de surtension incorporé

Actionneur thermoélectrique:

Cim EMV 311/NC 230
Cim EMV 311/NC 24
Cim EMV 311/NO 230
Cim EMV 311/NC 24
Actionneur 230V-24V NO - NC
230 VAC - 24 VAC

Tension de service:

Actionneur thermoélectrique:

Puissance de fonctionnement:

Classe de protection:

Poids:

Distance de réglage:

Puissance:

Longueur du câble:

Coloris de boîtier:

2.5 W
IP54
200 grms
4 mm
160 N
1 m
gris

Actuador termoeléctrico para la apertura y cierre de las válvulas en instalaciones de calefacción y refrigeración.

- Estructura compacta, tamaño pequeño
- Protección total contra pérdidas
- Indicador de funcionamiento
- Funcionamiento seguro y de larga duración
- Consumo de potencia reducido
- Posición de instalación 360°
- Preparado para la conexión de la válvula

Actuador termoeléctrico:

Cim EMV 311/NC 230
Cim EMV 311/NC 24
Cim EMV 311/NO 230
Cim EMV 311/NC 24
Actuador 230V-24V NO - NC
230 VAC - 24 VAC

Tensión de alimentación:

Frecuencia:

Potencia:

Clase de protección:

Peso:

Carrera máxima:

Fuerza del actuador:

Longitud del cable:

Color de la caja del motor:

2.5 W
IP54
200 grms
4 mm
160 N
1 m
gris

cim 3739B

Vanne d'équilibrage orifice variable à brides Válvula de equilibrio de orificio variable bridada

cim 3739B

DN 40÷150

DN 200÷300

UTILISATIONS: Les vannes d'équilibrage à brides **Cim 3739B** sont employées pour assurer un équilibrage optimal des débits dans les applications de chauffage ou de refroidissement de grandes dimensions.

Les vannes sont en fonte EN-JL 1040 avec brides percées PN 16.

Les vannes **Cim 3739B** ont un dispositif de mise en mémoire de la position de la vanne, ce qui permet son ouverture et fermeture à la même position prédéfinie. Elles sont fournies avec prises de pression **Cim 723**.

- Classe de pression: PN16 - Température: +10°C ÷ 120°C
- Brides: ISO 7005-2

APLICACIONES: Las válvulas de equilibrio bridadas **Cim 3739B** se emplean cuando es necesario un equilibrado correcto de los caudales en las instalaciones de calefacción y climatización de grandes dimensiones.

Las válvulas son de fundición EN-JL 1040 y tienen bridas perforadas y dimensionadas PN 16.

Las válvulas **Cim 3739B** están dotadas de un dispositivo para memorizar la posición de las válvulas, de tal modo que se pueden cerrar y volver a abrir en la posición exacta prefijada. Cuentan con tomas de presión **Cim 723**.

- Clase de presión: PN16. Temperatura: de -10°C a 120°C
- Brides: ISO 7005-2

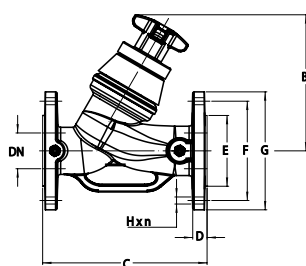

DN	€	Kg.	B	C	D	E	F	G	H	n	Kv-Kvs
40	286,65	8,2	178	200	14	84	110	150	19	4	26,15
50	297,70	11,6	190	230	16	99	125	165	19	4	47,50
65	338,40	15,6	214	290	17	118	145	185	19	4	79,70
80	409,05	19,8	225	310	19	132	160	200	19	8	116,80
100	621,25	34,8	334,5	350	21	156	180	220	19	8	196,80
125	813,85	52,4	369	400	22	178	210	250	19	8	360,00
150	1.073,90	78,6	403	480	21	211	240	285	23	8	387,80
200	2.013,00	173	732	600	26	266	295	340	23	12	724,80
250	4.480,50	254	739,5	730	29	320	355	405	28	12	866,00
300	7.274,00	350	848,5	850	28	370	410	460	28	12	1.474,60

CERTIFICADOS DE **EMPRESA**

ATUSA, na constante procura de fazer mais e melhor em todas as suas atividades, possui desde à muitos anos um Sistema de Gestão de Qualidade conforme a norma internacional ISO 9001 para a produção de materiais de fundição maleável bem como para a sua atividade comercial.

Da mesma forma, os produtos que a ATUSA comercializa nos mercados exigentes em que opera, usufruem de um grande prestígio e possuem as certificações necessárias para demonstrar a sua conformidade com as normas aplicáveis. Entre estas estão algumas de reconhecido prestígio internacional tais como:

AENOR (Espanha)
VDS y DVGW (Alemania)
SVGW (Suiza)
CERTIF (Portugal)
PZH (Polonia)
TSE (Turquia)
FM y UL (USA)
ULC (Canada)
ÜA (Austria)



Todos os produtos comercializados pela ATUSA estão assegurados de acordo com a Diretiva 85/374/CEE que regula a Responsabilidade Cível por danos por defeito de fabrico.

Em alguns casos e por prévio acordo com os clientes, a ATUSA fornece certificados de conformidade tipo 2.1 e 3.1 conforme a norma EN.

CONDIÇÕES GERAIS DE **VENDA**

As condições gerais de venda se consideram aceites pelo cliente no momento em que é efetuada a nota de encomenda. Não obstante, estas poderão ser modificadas por condições especiais previamente combinadas por escrito e confirmadas por ambas as partes.

Não terá efeito jurídico condições diferentes das aqui especificadas, não aceites explicitamente pela parte vendedora.

MERCADORIAS

Os nossos produtos são fornecidos com as nossas embalagens standard. Os artigos serão sempre fornecidos pela embalagem mínima de venda especificada no nosso catálogo.

Os dados incluídos neste catálogo são aproximados e a título informativo. ATUSA reserva-se no direito de modificar total ou parcialmente as características e materiais de qualquer dos seus produtos.

ENTREGAS

Os prazos de entrega são aproximados e sujeitos a modificações. As entregas parciais são permitidas sempre e quando não exista um acordo escrito que não o permita. Não respeitar o prazo de entrega não obriga a nenhuma indemnização por danos ou prejuízos.

PREÇOS E RESERVA DE PROPRIEDADE

Os preços indicados estão expressos em Euros, e estão sujeitos a IVA à taxa legal em vigor.

ATUSA reserva-se ao direito de propriedade da mercadoria fornecida até que o cliente não proceda ao pagamento integral da mesma. Até esse momento serão consideradas no conceito de depósito. Assim o vendedor poderá recuperar a mercadoria sem aviso prévio, em caso de não pagamento do comprador.

TRANSPORTE

Os preços desta tabela são considerados com portes pagos para envios em Portugal de mais de 250 € ou 30 Kg. de carga. Para importâncias e cargas inferiores às indicadas o despacho é efetuado com cobrança de portes.

Sempre que a mercadoria seja enviada com portes pagos, a parte vendedora poderá escolher a empresa de transporte. Não obstante a parte compradora poderá sempre solicitar a venda com portes a cobrar, escolhendo assim a transportadora que mais lhe convier.

DEVOLUÇÕES

Não serão aceites devoluções que não tenham consentimento por escrito do nosso Dpto. Comercial. O material devolvido deve ser acompanhado por uma guia de entrega indicando o código do produto, quantidade e motivo da devolução. No caso de devoluções com portes a cobrar, será o Dpto. Comercial da ATUSA quem indicará a transportadora para o levantamento do material. O incumprimento de qualquer das condições indicadas pressupõe a não aceitação da devolução.

Todo o material devolvido por motivos não imputados à ATUSA terá uma desvalorização mínima de 25% para manuseamento. Não se admitem devoluções de produtos que não cumpram com as condições de venda ou não mantenham a embalagem original.

Apenas serão aceites reclamações por quantidade ou defeito da mercadoria no prazo máximo de 7 dias úteis após a expedição do mesmo. Nos demais casos não se aceitam devoluções após 30 dias depois da expedição.

GARANTIAS

Os produtos ATUSA têm dois anos de garantia a partir da data de entrega. Durante este período, a ATUSA compromete-se com a substituição dos artigos com defeito de fabrico, excluindo defeitos por deficiente manuseamento, ou transporte. A cobertura de esta garantia não inclui substituição daqueles produtos deteriorados por um tratamento inapropriado, montagem defeituosa ou um uso inadequado.

ATUSA dispõe de um Seguro de Responsabilidade Cível de acordo com a lei vigente.

JURISDIÇÃO

Para os litígios que possam surgir no decorrer da relação contratual entre a parte compradora e a ATUSA PORTUGAL, submetem-se expressamente à jurisdição do Tribunal da Comarca da Maia.